



This is a digital copy of a book that was preserved for generations on library shelves before it was carefully scanned by Google as part of a project to make the world's books discoverable online.

It has survived long enough for the copyright to expire and the book to enter the public domain. A public domain book is one that was never subject to copyright or whose legal copyright term has expired. Whether a book is in the public domain may vary country to country. Public domain books are our gateways to the past, representing a wealth of history, culture and knowledge that's often difficult to discover.

Marks, notations and other marginalia present in the original volume will appear in this file - a reminder of this book's long journey from the publisher to a library and finally to you.

Usage guidelines

Google is proud to partner with libraries to digitize public domain materials and make them widely accessible. Public domain books belong to the public and we are merely their custodians. Nevertheless, this work is expensive, so in order to keep providing this resource, we have taken steps to prevent abuse by commercial parties, including placing technical restrictions on automated querying.

We also ask that you:

- + *Make non-commercial use of the files* We designed Google Book Search for use by individuals, and we request that you use these files for personal, non-commercial purposes.
- + *Refrain from automated querying* Do not send automated queries of any sort to Google's system: If you are conducting research on machine translation, optical character recognition or other areas where access to a large amount of text is helpful, please contact us. We encourage the use of public domain materials for these purposes and may be able to help.
- + *Maintain attribution* The Google "watermark" you see on each file is essential for informing people about this project and helping them find additional materials through Google Book Search. Please do not remove it.
- + *Keep it legal* Whatever your use, remember that you are responsible for ensuring that what you are doing is legal. Do not assume that just because we believe a book is in the public domain for users in the United States, that the work is also in the public domain for users in other countries. Whether a book is still in copyright varies from country to country, and we can't offer guidance on whether any specific use of any specific book is allowed. Please do not assume that a book's appearance in Google Book Search means it can be used in any manner anywhere in the world. Copyright infringement liability can be quite severe.

About Google Book Search

Google's mission is to organize the world's information and to make it universally accessible and useful. Google Book Search helps readers discover the world's books while helping authors and publishers reach new audiences. You can search through the full text of this book on the web at <http://books.google.com/>

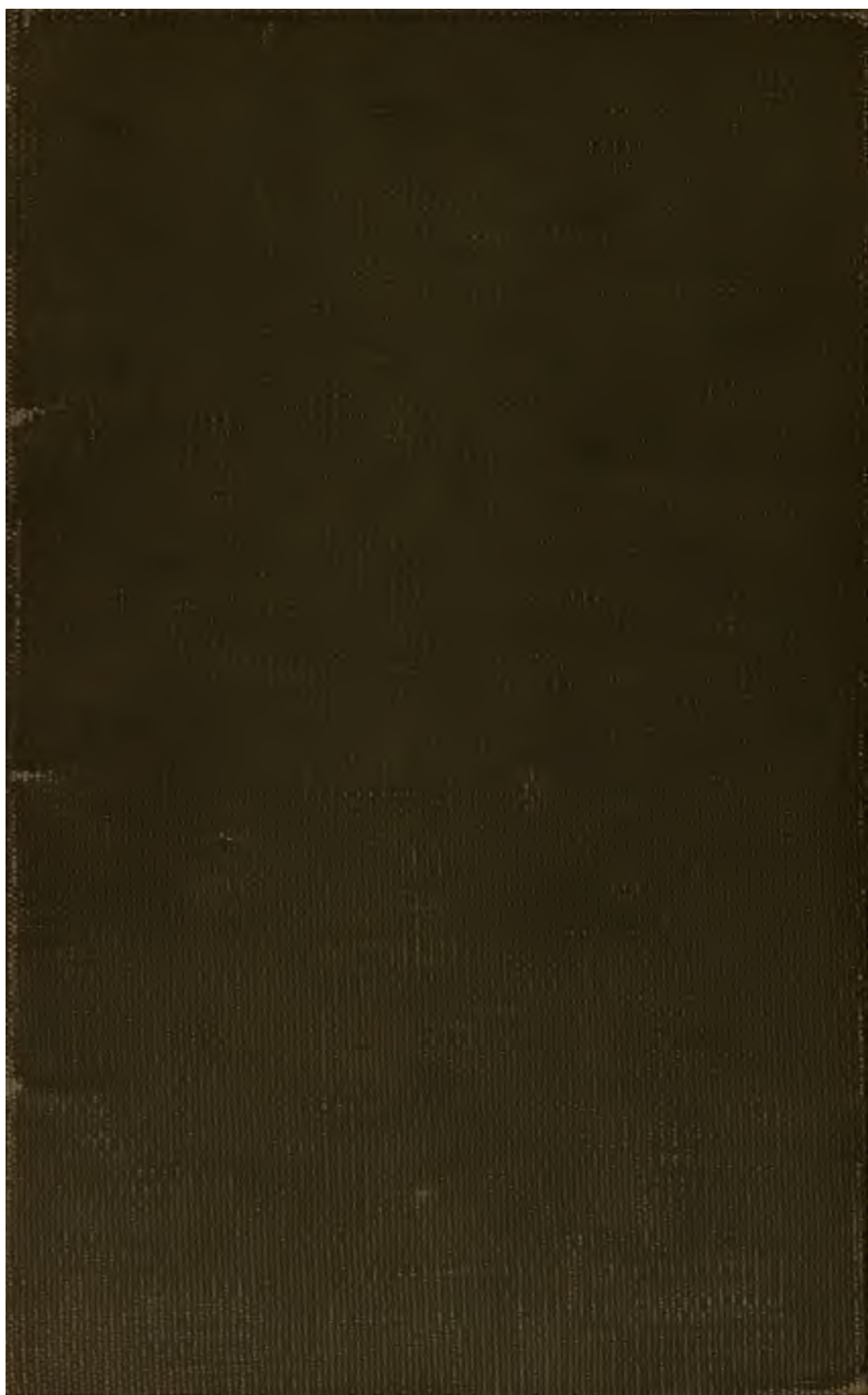

Phys 408.94.3

Harvard College Library



FROM THE BEQUEST OF

THOMAS WREN WARD

Late Treasurer of Harvard College

The sum of \$5000 was received in 1858,
"the income to be annually expended
for the purchase of books."

SCIENCE CENTER LIBRARY

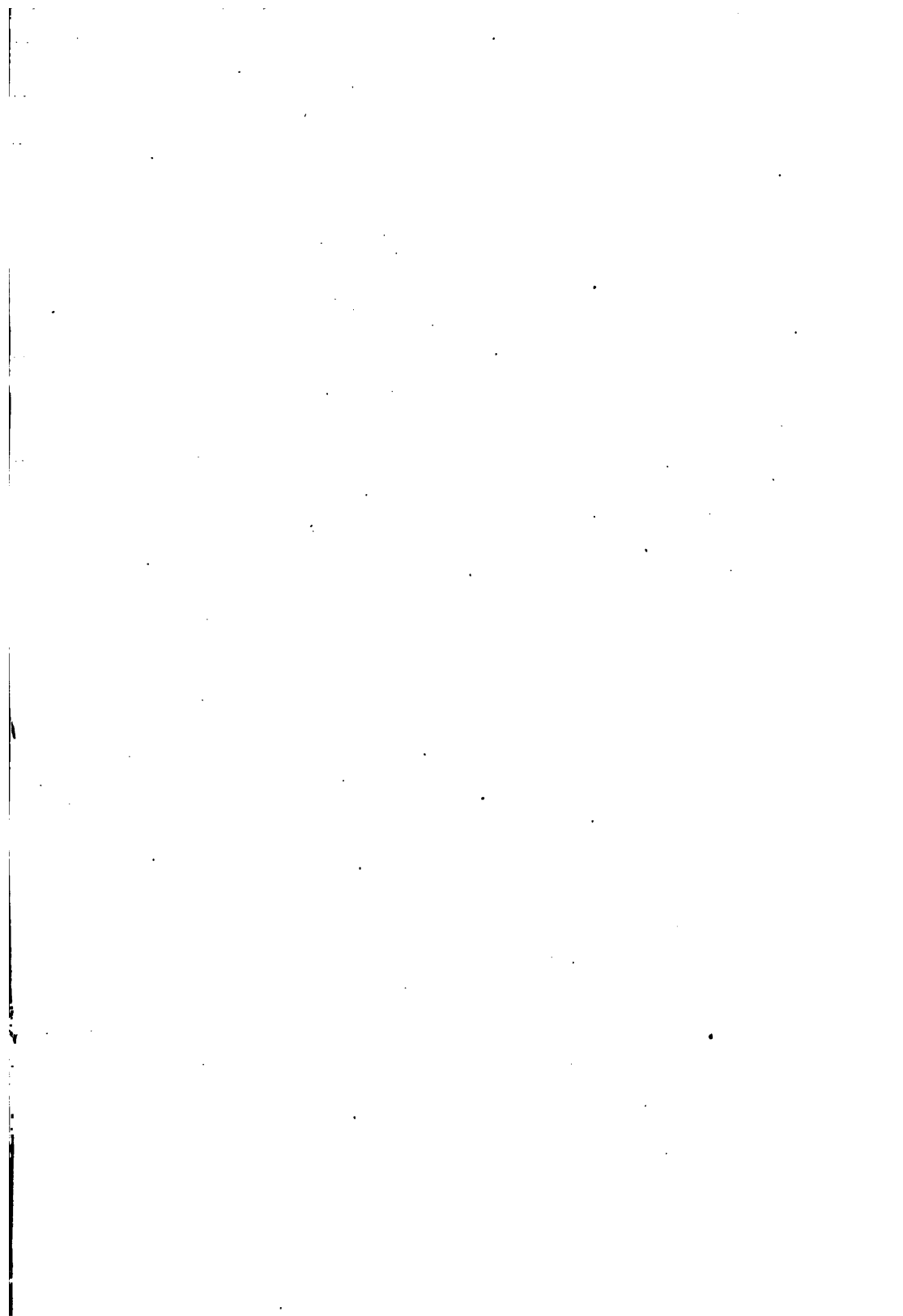

Vertical line of text on the left side of the page.

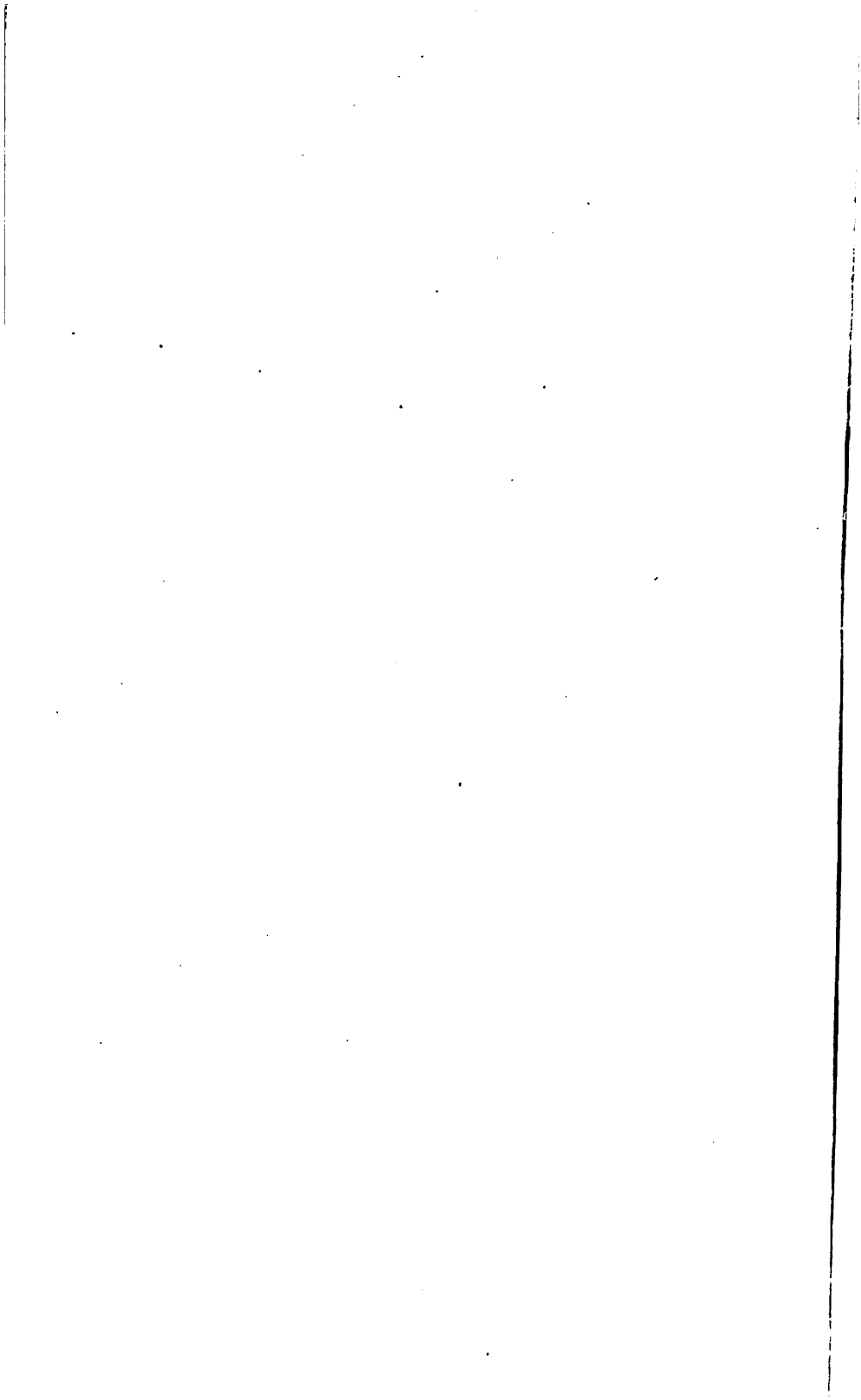

PHYSICO-CHEMICAL MEASUREMENTS

7



©

MANUAL
OF
PHYSICO-CHEMICAL
MEASUREMENTS

BY

WILHELM OSTWALD

PROFESSOR OF CHEMISTRY IN THE UNIVERSITY OF LEIPZIG

TRANSLATED WITH THE AUTHOR'S SANCTION BY

JAMES WALKER, D.Sc., Ph.D.

PROFESSOR OF CHEMISTRY IN UNIVERSITY COLLEGE, DUNDEE

London
MACMILLAN AND CO.
AND NEW YORK
1894

All rights reserved

~~V. 4998~~

Phys 408.94.3

5
17/8

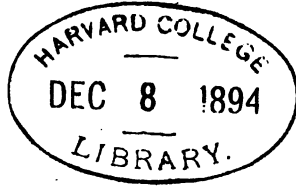

Grand fund.

BIND.

20 JUL 1912

AUTHOR'S PREFACE

THE present book was written first of all with a view to lighten my own teaching, but also with the intention of furthering the performance of physico-chemical measurements by other chemists and physicists. I have endeavoured to collect in it what is of importance for the execution of desirable experiments and accurate measurements in this branch of science. To a certain extent I could avail myself of various works already published, especially of Kohlrausch's classical *Introduction to Physical Measurements*, from which the section on weight-testing and several tables have been reproduced almost unaltered with the author's kind permission. The purpose and contents of the book, however, are sufficiently distinct from those of former publications to justify the production of a new work. I have not written for the beginner, who has neither acquired the manipulative skill necessary for the performance of the experiments nor a sufficient knowledge of the more important processes, but for the chemist or the physicist who has already gone through the greater part of his special course, and recognises the necessity of making himself acquainted with the borderland between the two sciences, which has of late attained to such importance. I also hope to be of service to the practical man who may not have had the opportunity of learning the new methods, although their practical importance in the most varied applications is beyond question.

With this purpose in view it was necessary to emphasise throughout the book the question of the magnitude of possible errors, or the requisite accuracy of measurements and calculations, for the average

chemist has even yet a very imperfect acquaintance with this most essential subject. Again, physical chemistry has the peculiarity that its methods and appliances are daily being extended and altered, so that the experimenter must have a large stock both of material and of practical artifices at his command as a provision against the constantly changing problems he encounters. I have therefore devoted a considerable space to the discussion of these practical matters. In the first place, I have striven to combat that helplessness nowadays so prevalent amongst experimenters, who have to resort to the mechanic for every trifle, because they cannot trust themselves to bore a hole or solder on a wire. I must confess in this connection that I have always taken a special pleasure in "pottering" and making things for myself. Many of my investigations have been conducted with home-made apparatus, and the advantages I derived from this mode of working have been so considerable that I cannot refrain from urging my fellow-workers to adopt it.

A book such as this can of course make no pretension to completeness. There will undoubtedly be many devices and appliances which I have left unnoticed, and for the measurement of some of the magnitudes there may be simpler or more accurate methods. I therefore ask the assistance of my colleagues into whose hands the book may come, and shall be grateful for any hint which will lead to its future improvement.

I have restricted the tables to those which are absolutely essential; the excessively accurate work of Landolt and Börnstein contains everything else that is necessary. The value of the book I hope to have increased by giving reprints of the tables on separate sheets, so that in actual work the whole volume need not always be kept open before the student.

W. OSTWALD.

LEIPZIG, *July* 1893.

CONTENTS

CHAPTER I

CALCULATION

	PAGE
PRELIMINARY CALCULATIONS	1
COMPOSITE MEASUREMENTS	2
CALCULATION OF MEASUREMENTS	4
MEAN ERROR	5
COMPOSITE ERRORS	6
INCIDENTAL AND CONSTANT ERRORS	7
PROBABLE VALUE OF A CONSTANT INTERVAL	8
CORRECTIONS	8
GRAPHIC INTERPOLATION	10
USE OF CORRECTIONS	11
MULTIPLE CORRECTIONS	11
RULES FOR ARITHMETICAL COMPUTATION	13
AIDS TO CALCULATION	15
SLIDE RULES	16
CONSTRUCTION OF A SLIDE RULE	17
LOGARITHMIC CALCULATING TABLES	19
OTHER AIDS	20

CHAPTER II

MEASUREMENT OF LENGTH

THE DIVIDING ENGINE	22
SCALES ON GLASS	23
ETCHING ON GLASS	24
TESTING THE DIVIDING ENGINE	25
OTHER DIVIDING INSTRUMENTS	26
ARBITRARY UNITS	27

	PAGE
MEASUREMENTS OF LENGTH	28
THE READING	30
VERNIER AND MICROSCOPE	32
MEASUREMENTS OF SURFACE	33
MEASUREMENTS OF VOLUME	34

CHAPTER III

WEIGHING

THE BALANCE	35
WEIGHING	36
BUOYANCY OF THE AIR	38
THE WEIGHTS	40
TESTING WEIGHTS	41

CHAPTER IV

MEASUREMENT AND REGULATION OF TEMPERATURE

THE MERCURY THERMOMETER	45
THE FREEZING POINT	46
THE BOILING POINT	47
CALIBRATION OF A TUBE	47

CHAPTER V

THERMOSTATS

MELTING POINTS	51
BOILING POINTS	52
AUTOMATIC TEMPERATURE REGULATORS	54
THE GAS REGULATOR	55
VAPOUR REGULATORS	57
LIQUID THERMOSTATS	59
THERMOSTATS WITH SOLIDS	61
ELECTROMAGNETIC REGULATORS	62
THE BATH	63
THE STIRRING GEAR	64
MOTORS	65

CHAPTER VI

GLASS-BLOWING

	PAGE
CUTTING TUBES	67
CLOSING TUBES	68
DRAWING-OUT TUBES	68
BLOWING BULBS	68
JOINING TUBES	69
T-TUBES	70
BENDING TUBES	70
TURNING-OUT BORDERS	70
SEALING PLATINUM WIRES	71
WELDING AND SOLDERING PLATINUM	72

CHAPTER VII

MEASUREMENT OF PRESSURE

MANOMETERS	73
READING THE HEIGHT OF MERCURY	74
VACUUM MANOMETERS	76
BAROMETERS	77
HIGH PRESSURES	78
SPRING MANOMETERS	79
PISTON MANOMETERS	81

CHAPTER VIII

VOLUME AND DENSITY

MEASUREMENT OF VOLUME	82
PURIFICATION OF MERCURY	84
APPARATUS FOR MEASURING VOLUMES	84
DIVIDED PIPETTES	89
MEASURING FLASKS AND CYLINDERS	89
SPECIFIC GRAVITY AND VOLUME	90
PYKNOMETERS	90
WEIGHING GLASS VESSELS	93
DENSITY DETERMINATIONS WITH THE PIPETTE	94
THE HYDROSTATIC BALANCE	94
FAHRENHEIT'S HYDROMETER	95

	PAGE
AREOMETERS	95
SPECIFIC GRAVITY BALLS	96
SOLIDS	96
METHOD OF FLOATING	98
GASES	99
GAS DENSITY AND VAPOUR DENSITY	100
DUMAS'S METHOD	103
GAY-LUSSAC AND HOFMANN'S METHOD	104
CALIBRATION OF MEASURING TUBES FOR GASES	106

CHAPTER IX

DILATATION, BOILING POINT, VAPOUR PRESSURE, AND CRITICAL
CONSTANTS

DILATATION OF LIQUIDS	108
MOLECULAR VOLUME OF LIQUIDS AT THEIR BOILING POINTS	111
DETERMINATION OF BOILING POINTS	112
DETERMINATION OF VAPOUR PRESSURES	112
METHOD OF EVAPORATION	113
CRITICAL TEMPERATURE	114
CRITICAL PRESSURE	116
CRITICAL VOLUME	117

CHAPTER X

CALORIMETRY

CALORIMETRIC THERMOMETERS	119
CALORIMETERS	120
HEAT CAPACITY OF CALORIMETER	121
THE UNIT OF HEAT	123
HEAT EXCHANGE WITH ENVIRONMENT	124
SPECIFIC HEATS	127
HEAT OF FUSION	129
HEAT OF VAPORISATION	130
HEAT OF SOLUTION	132
CALORIMETERS WITH SEPARATE CHAMBER	132
REACTIONS IN DILUTE SOLUTIONS	133
HEAT OF COMBUSTION	134
THE ICE CALORIMETER	136

CONTENTS

xi

PAGE

95

96

CHAPTER XI

96

OPTICAL MEASUREMENTS

98

99

PAGE

100

REFRACTION COEFFICIENTS 139

103

PULFRICH'S REFRACTOMETER 142

104

ABBE'S REFRACTOMETER 144

106

DIFFERENTIAL REFRACTOMETER 144

LIGHT OF DEFINITE WAVE-LENGTH 145

CONSTANTS OF REFRACTION 146

SPECTRUM OBSERVATIONS 147

PRODUCTION OF SPECTRA 149

COLORIMETRY 150

SPECTROPHOTOMETRY 152

PHOTOGRAPHY 155

PHOTOGRAPHIC RECIPES 157

108

ROTATION OF THE PLANE OF POLARISATION 158

111

THE OBSERVING TUBES 160

112

112

CHAPTER XII

113

VISCOSITY AND SURFACE TENSION

114

116

VISCOSITY 162

117

SURFACE TENSION 163

CHAPTER XIII

SOLUBILITY

119

LIQUIDS IN GASES 170

120

SOLIDS IN GASES 172

21

GASES IN LIQUIDS 173

23

PREPARATION OF GAS-FREE LIQUIDS 174

24

CHEMICAL METHODS 174

27

LIQUIDS IN LIQUIDS 175

29

SOLIDS IN LIQUIDS 176

30

CHAPTER XIV

32

DETERMINATION OF MOLECULAR WEIGHTS IN SOLUTIONS

33

34

DEPRESSION OF THE FREEZING POINT 180

36

EXACT MEASUREMENTS 183

	PAGE
ELEVATION OF THE BOILING POINT	184
GAS CURRENTS, AIR-PUMPS, ETC.	189

CHAPTER XV

ELECTRICAL MEASUREMENTS

ELECTRICAL UNITS	192
THE CLARK ELEMENT	193
OTHER NORMAL ELEMENTS	195
SOURCES OF CURRENT	196
CONNECTIONS, KEYS, BINDING SCREWS	197
GALVANOMETERS	200
ELECTROMETERS	202
THOMSON'S QUADRANT ELECTROMETER	208
MEASUREMENT OF E.M.F.	209
POTENTIAL DIFFERENCES	214
NORMAL ELECTRODES	215
RESISTANCE—WHEATSTONE'S BRIDGE	216
SOLDERING	220
CONDUCTIVITY OF ELECTROLYTES	222
MOLECULAR CONDUCTIVITY	228
THE DISSOCIATION CONSTANT	233
PURE WATER	234
BASICITY OF ACIDS	235
TABLE FOR THE DISSOCIATION CONSTANT	236
ELECTRICAL MEASUREMENT OF TEMPERATURE	242

CHAPTER XVI

CHEMICAL DYNAMICS

VELOCITY OF CHEMICAL PROCESSES	246
VOLUMETRIC METHODS	247
VESSELS FOR VELOCITY OF REACTION	248
CATALYSIS OF METHYL ACETATE	250
INVERSION OF CANE-SUGAR	251
INDEX	253

192
193
195
196
197
200
202
208
209
214
215
216
220
222
228
233
234
235
236
242

CHAPTER I

CALCULATION

ALL observations involving measurement entail corresponding calculations, some of which precede and some follow the actual observation. The object of the preliminary calculation is to indicate the proper arrangement and combination of the measurements, and to fix the plan of the investigation in such a way as to secure the wished-for degree of accuracy. The final calculations arise from the readings of the instrument employed not giving, as a rule, the desired numerical result directly, but only a function of it. It is only by introducing the observed value into an equation, which usually contains several other numerical factors, that the final value is obtained; in many cases several such steps may have to be taken. The calculation after the measurement, or the reduction, consists therefore essentially in the numerical solution of equations, other mathematical considerations only appearing when there is a question of the most suitable practical method of calculation on the one hand, and of the determination of the most probable result from several independent measurements of the same magnitude on the other. We shall consider these different problems separately.

Preliminary Calculations—The Definition.—The first question to be considered in sketching out a plan of measurement is not with regard to the sensitiveness of the measuring process, but rather the exactness with which the object is defined. Things we call by the same name are in nowise as a rule strictly the same, and each separate thing undergoes alteration in the course of time. Consequently, before we can form any conclusion with regard to the accuracy of any measurement, we must have a clear conception as to the degree of approximation to which the object specially subjected to measurement is to be considered constant and capable of reproduction. A given object at a given moment may be measured with any degree of accuracy we please, and in this direction there is no limit to the delicacy of the process we may employ. But the practical question

246
247
248
250
251
253

is, How great is the difference when we measure another sample of the same object, or the first object itself at another time? This is what we shall call the "definition" of the object.

We are now in a position to formulate the fundamental rule for drawing up a plan of measurement:—The accuracy of the measurement must correspond to the exactness of the definition of the object to be measured. Thus the chemist who weighs off 63 g. of oxalic acid for a litre of normal solution on a rough balance accurate to 1/20 g. commits no error; for a normal acid solution can scarcely be defined volumetrically with more exactness than to 0.2 %, and since the possible error in weighing as above is less than 0.2 %, viz. 0.08 %, the process is sufficiently accurate for the purpose. On the other hand, it must be accounted an error in method (although not in result) when a physicist, in order to prepare a salt solution of known strength, weighs 100 g. of water on the same delicate balance as the 1 g. of salt required, and strives to attain the same limit of accuracy, about 0.2 mg., in both cases. The definition of such a quantity of water, which must be manipulated in open vessels, decanted, etc., is uncertain by several milligrams on account of the evaporation which takes place. Besides, an error of 0.2 mg. in the weight of the salt occasions the same error in the strength of the solution as a hundred times greater error in the weight of the water, viz. 20 mg. It is therefore quite useless in weighing the water to seek greater accuracy than about 5 or 10 mg. This point, the reciprocal adjustment of connected measurements, will be discussed more fully in the sequel.

It sometimes happens, especially in new fields of inquiry, that we do not possess an antecedent knowledge of the sharpness of definition of the object. In such a case we choose methods of measurement which approximately correspond to the accuracy aimed at, and measure the same object under as varied conditions as we can. The observed deviations give us the desired information; and if they remain within the limits pertaining to the method itself, we may then select a more accurate mode of procedure.

Composite Measurements.—Only in comparatively rare cases are the desired results to be ascertained from a single measurement or its repetition. Several sorts of measurement usually enter into the result, and we must settle what degree of accuracy is to be attained in each group.

If we represent the result r in the form

$$r=f(a, b, c \dots)$$

where f is a general functional symbol, and $a, b, c \dots$ the various distinct magnitudes, whether constants or results of measurement, entering into the result, then the general condition is that the influence

of each of the magnitudes $a, b, c \dots$ on r shall be equal, *i.e.* that

$$\left(\frac{\delta r}{\delta a}\right) da = \left(\frac{\delta r}{\delta b}\right) db = \left(\frac{\delta r}{\delta c}\right) dc = \dots$$

This condition cannot in general be immediately fulfilled. Some of the magnitudes $a, b, c \dots$ will, with the same degree of trouble, always be much more exactly determinable than the others. If the calculation is carried out, the errors estimated from the nature of the measurements being introduced for $da, db, dc \dots$, it soon appears that, as a rule, very considerable differences exist in the values of the partial differential quotients. We have then to turn our attention to the measurements whose assumed error creates the greatest error in the result, and consider whether a diminution of this value can be effected by a change in the mode of experiment, the employment of new or more delicate apparatus, etc. This result is frequently only attainable at the expense of accuracy in the other parts of the group of measurements, in which case we must adopt a compromise to bring about a practicable approximation to the above equation.

A few simple cases may be reckoned out to show the application of the process. Suppose, for example, a magnitude r to be determined as the sum or difference of two others, a and b . We have then

$$r = a \pm b$$

$$\frac{\delta r}{\delta a} da = da, \quad \frac{\delta r}{\delta b} db = \pm db.$$

Consequently da must be made numerically equal to db , *i.e.* both values must be measured to the same absolute degree of accuracy.

If the magnitude r is given as the product of a and b , then

$$r = ab$$

$$\frac{\delta r}{\delta a} da = bda, \quad \frac{\delta r}{\delta b} db = adb.$$

The condition to be fulfilled is therefore

$$bda = adb,$$

or

$$\frac{da}{a} = \frac{db}{b}.$$

The two magnitudes must therefore be measured with equal relative exactness, *i.e.* to the same fraction of their value.

If the magnitude r appears as a quotient, then

$$r = \frac{a}{b}$$

$$\frac{\delta r}{\delta a} da = \frac{da}{b}, \quad \frac{\delta r}{\delta b} db = -\frac{a}{b^2} db,$$

and we have

$$\frac{da}{b} = -\frac{a}{b^2} db,$$

or

$$\frac{da}{a} = -\frac{db}{b},$$

the same condition as in the case of the product.

If we have r in the form $a + mb$, where m may be considered a coefficient free from error, then

$$\frac{\delta r}{\delta a} da = da, \quad \frac{\delta r}{\delta b} db = mdb$$

$$da = mdb.$$

The error of b should be m times smaller than that of a .

The similar treatment of other cases with respect to any definite problem may be left to the reader.

Calculations like the foregoing are, in the first instance, to be made with all the magnitudes which are susceptible of error; absolute coefficients, like the numbers π and e (the base of the natural logarithms), are not in question. It often occurs that certain measured quantities may be determined with little trouble so exactly that their influence on the error of the result is insignificant with respect to the other magnitudes, less than a fifth or a tenth of the influence of the others. Such magnitudes may likewise be treated as absolutely exact, and neglected in estimating the ultimate error. It would be arbitrary under any circumstances to fix a limit for this, but if one ultimate error is less than a tenth of the others, we are always justified in neglecting it for our purposes, often indeed when it amounts to a fifth.

Calculation of Measurements.—When the plan of measurement has been fixed, the apparatus is set up, corrected or calibrated (*vide infra*), and the measurements are then executed. In general each thing to be observed will be measured several times, partly to guard against chance errors in reading off or noting down, partly to learn the exactness of definition and to ascertain the amount of the actual

errors so far as they are dependent on the conditions which still remain variable.

From n repeated measurements $a_1, a_2, a_3 \dots$ of the same magnitude, the most probable mean a is the arithmetical mean.

$$a = \frac{a_1 + a_2 + a_3 \dots + a_n}{n} = \frac{\Sigma a}{n}.$$

In calculating out it is not necessary to sum the whole values of the a 's; it is more to the purpose to sum the deviations of $a_1, a_2, a_3 \dots$ from a neighbouring round number, take the mean of these and add this to the round number. In other words, each a_n is decomposed into a constant value a_0 plus a small addendum a_n , so that $a_1 = a_0 + a_1$, $a_2 = a_0 + a_2$, etc., whence it follows directly that

$$a = a_0 + \frac{a_1 + a_2 + \dots + a_n}{n}.$$

Suppose, for example, the following numbers to have been read off on a divided circle:— $23^\circ 13$, $23^\circ 15$, $23^\circ 16$, $23^\circ 12$, $23^\circ 09$. We may put $a_0 = 23^\circ 10$, and for a we have 3, 5, 6, 2, -1 respectively. The sum is 15, the mean 3.0, consequently the mean value required is $a = 23^\circ 10 + 0^\circ 030 = 23^\circ 130$. We see from this example how we may, to begin with, treat the last place of decimals as whole numbers, and only put them in their proper place in the final result. The mean is in general calculated to one decimal place further than that given by the observations.

The mean of the direct results of measurement should always be taken, not that of the functions calculated from them. If the divided circle, for instance, belongs to a tangent galvanometer, we do not find the tangent of each reading and then draw the mean, but take the average of the readings themselves and find the tangent of the mean value of the angle. This is not only practically the most convenient mode of procedure, but also theoretically the most accurate.

Mean Error.—The calculus of probabilities gives for the mean error f which may be assumed to affect each single observation, the expression

$$f = \pm \sqrt{\frac{\Sigma d^2}{n-1}},$$

and for the mean error F of the mean of the whole

$$F = \pm \sqrt{\frac{\Sigma d^2}{n(n-1)}}.$$

Here d signifies the deviation of each measurement from the mean, *i.e.* $d_1 = a - a_1$, $d_2 = a - a_2$, etc. Σd^2 is the sum of the squares

of these deviations, and n as before the number of observations. In the example given above, $\Sigma d^2 = 0 + 4 + 9 + 1 + 16 = 30$, consequently $f = 2.7$ and $F = 1.2$. The result of the five measurements should therefore be written $a = 23^{\circ}130 \pm 0^{\circ}012$.

From the formula for F it follows that the mean error of the result may be diminished by repeating the observations, but only proportionally to the square root of their number. Thus, in order to bring the mean error to half, $0^{\circ}006$, we should have to make four times as many observations, *i.e.* 20.

The mean error of a single observation is naturally made no smaller by repetition of the observations, but only becomes better defined.

Besides these mean errors there are also in common use the "probable" errors which are obtained from the former by multiplying them by 0.6745 , or roughly $2/3$. I see no benefit to be derived from their use.

The calculation of the mean error is undertaken on the one hand in order to judge of the accuracy of the result obtained, on the other hand to get a method of combining to a general mean several determinations of mean values of the same magnitude arrived at in different ways. For the last purpose, the measure of accuracy or the "weight" is taken to be inversely proportional to the square of the mean error F , *i.e.* $p = \frac{1}{F^2}$. If $m_1, m_2 \dots$ are the separate means, then the general mean is¹

$$m = \frac{p_1 m_1 + p_2 m_2 + \dots}{p_1 + p_2 + \dots},$$

and the mean error of the general mean is

$$F_0 = \sqrt{\frac{\Sigma p d^2}{(n-1)\Sigma p}}.$$

These formulæ are only valid on the assumption that there is no constant error affecting the different methods by which the means m_1, m_2 , etc., were determined. This assumption is much less frequently justified than one would be inclined to imagine.

Composite Errors.—The calculations necessary for ascertaining the error in the result of a composite observation are precisely similar to those we have already made (p. 3) to determine the influence of the separate measurements on the result. We have to subject the formula for the result

$$r = f(a, b, c \dots)$$

¹ The calculation may be simplified in the same manner as on p. 5.

to partial differentiation with respect to $a, b, c \dots$, and obtain in the form $\frac{\delta r}{\delta a}, \frac{\delta r}{\delta b} \dots$ the factors by which the errors $da, db \dots$, in $a, b \dots$, are to be multiplied in order to obtain the corresponding error in r .

The total mean error is in the worst conceivable case, viz. when the partial errors all have the same sign and their mean value, equal to the sum of the partial errors $dr = \frac{\delta r}{\delta a} da + \frac{\delta r}{\delta b} db + \dots$. The mean value of the total error is $Fr = \sqrt{(fa)^2 + (fb)^2 + \dots}$, where, for the sake of brevity, $\frac{\delta r}{\delta a} da = fa$, etc., has been written.

Incidental and Constant Errors.—If we wish to make repeated measurements of the same magnitude, all the circumstances which affect this magnitude must remain constant, or be brought into the calculation as corrections. The remaining differences amongst the separate determinations will then be due to small variations in the circumstances which we cannot regulate, to the uncertainty of the readings, chance disturbances, and similar causes, the action of which, as a rule, will make the observed values just as often too high as too low. In such a case the arithmetical mean of the readings is, as we have already said, the most probable value of the result.

But this condition that all circumstances which influence the final result are either constant or have their effect exactly taken into account, can never in strictness be fulfilled; the deviations can only be reduced to an amount less than a certain limit, which then represents the limit of error of the measurements. The condition is also broken in another way. To take account of all influences, we must know what they are, and that is precisely what we do not in general know when dealing with still unfamiliar phenomena.

We must therefore, as a rule, assume that together with the influencing circumstances taken into account there exist others, whose amount is unknown, and which do not appear in the mean error of the result, when they do not change, or change but little, in the course of the series of measurements. For instance, if the specific gravity of copper is to be determined, and the experimental piece of metal has an air-bubble or blister in it, too small a value will be obtained, and since the cause of the error is constant, its amount will never be included in the value of the mean error.

The mode of discovering such constant errors is to measure the magnitude with different objects and by means of different methods. If the separate mean values do not differ from each other by more than is to be expected from the amounts of the mean error of each mean, then constant errors are either not present or they are the same and of the same magnitude in every case. The second alternative evidently becomes less probable as the variety of methods

employed increases, and we may attain considerable certainty in this respect with even three or four independent series of experiments.

It must be emphasised that this condition for the application of the calculus of probabilities in our branch of the metric sciences is only extremely rarely fulfilled. For example, all atomic weight determinations of one and the same element, with the single exception of Stas's measurements, differ more from each other than the mean errors of the separate series would indicate, and this not only holds good for the measurements of different observers, but also for the measurements of the same observer made by different methods. In all these experiments, therefore, there remained constant errors whose cause had escaped the attention of the investigators. The state of affairs in other branches is similar and, for the most part, worse.

The application of the calculus of probabilities and the resulting method of least squares is therefore in the case of most physico-chemical measurements not only superfluous, but actually erroneous, for it assumes a condition which is usually very far from being fulfilled. On the other hand, the calculation of the mean errors of different series is of great use as giving us in the comparison of independent series an idea of the minimum amount of the constant errors of one or of all the methods, and thus indicating means for their discovery and eventual removal.

Probable Value of a Constant Interval.—If in the function $x = a + bn$ we determine the values of x for different integral values of n , then the most probable value of the mean of the interval b is given by the expression

$$b = 6 \frac{(n-1)(x_n - x_1) + (n-3)(x_{n-1} - x_2) + \dots}{n(n^2 - 1)}$$

Problems like this occur very frequently; for instance, in determining the value for the influence of CH_2 on the properties of homologous series. If we only took the arithmetical mean of the b 's for the successive values of n , the influence of the intermediate measurements would vanish, as we can easily see, and the value of b become equal to $\frac{x_n - x_1}{n - 1}$, *i.e.* as if only the extreme measurements had been made.

In each case too it must be proved that the assumption of the constancy of b is justified. In the example given above, this is mostly doubtful.

Corrections.—Every divided instrument is affected with errors of the scale, which are frequently greater than the errors of the reading, and must therefore be corrected by calibration before being used for exact measurements. The process usually consists in

measuring an object, whose constancy with respect to the measured magnitude is certain (or whose variability is accurately known), at various places of the divided instrument. The deviations of these different measurements from one another give us the amount of the error.

The systematic plan of making the corrections varies from case to case, but the problem always is to attain the maximum of accuracy with the minimum of work. Several typical cases will be fully discussed in the sequel.

With instruments, in which the measured value is obtained by adding together several individual pieces (*e.g.* sets of weights, resistance boxes), we have only to make a limited number of corrections, *i.e.* as many as there are pieces in the set. In this case the plan is so arranged that we obtain experimentally as many equations between the pieces, *viz.* $n - 1$ if n is the number of pieces, as are necessary to determine their relations to each other. If no further relation is given, *e.g.* to a standard unit, then the sum of all the pieces is assumed to be equal to the nominal value, and we calculate by means of the experimental determinations the true value of each piece. The difference, true value minus nominal value, gives the correction for the piece, *i.e.* the quantity which has to be added to the nominal value to give the true value. If a standard unit is given in addition, then the ratio between it and the piece of the same nominal value is also determined, and the rest of the calculation made with respect to it.

When it is not possible to make up the measured magnitude of separate pieces, the instrument is divided continuously, and always, except in very special circumstances, into equal intervals. The correction cannot then be applied to each individual interval, but a definite number of intervals, 10, 50, or 100, are treated as one unit and the corrections determined in a similar way for these. We then proceed on the assumption that the errors vary slowly and continuously. If therefore the errors, *i.e.* the deviations from the true value, are determined for a certain number of places on the scale, we are justified in estimating the errors at intermediate places on the assumption that they run continuously into the measured errors, *i.e.* in interpolating them.

The interpolation has to be made more or less thoroughly according to the relative amount of the errors. If the deviations are very small and very regular, we may assume that the error changes proportionally between the points examined. If the error at the point a is equal to α , and at b equal to β , then at an intermediate point c the error γ is found by seeking a value occupying the same relative position between a and β as c does between a and b . Thus, if a thermometer has an error of $+0.23$ at 10° and of $+0.11$ at 20° , then at 13° the error is $+0.19$.

This simple proportional calculation in cases where the error is more considerable or is to be more accurately determined, must be replaced by a somewhat more probable assumption: a function is sought which will represent the errors continuously and permit the calculation of the intermediate values. It is much more convenient in this case to represent the errors graphically and not arithmetically, and to take the interpolated values directly from the curve.

The objection is often raised against this method that it is arbitrary, but the assumptions made in algebraical interpolation (without which no interpolation is possible at all), such, for instance, as the assumption that three consecutive points lie on a parabola, are just as arbitrary, and the graphic method has the great advantage of rapidity and clearness.

Graphic Interpolation.—Paper can be purchased which is covered with a network of straight lines ruled at a distance of 1 mm. from one another, the fives and tens being specially indicated. This paper is very suitable for purposes of interpolation. The process is to plot the nominal values as abscissæ on a suitable scale (total length 20 to 50 cm.) and the corrections on a magnified scale as ordinates. The points obtained are then connected by a continuous curve, whose ordinates give the error for all intermediate points.



FIG. 1.

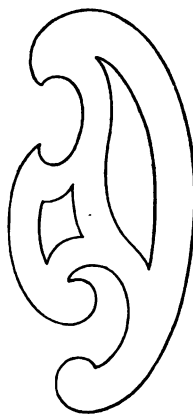

FIG. 2.

Drawing the curve by free-hand can only be done satisfactorily by expert draughtsmen. Very useful results may be obtained, however, by sketching in lightly the approximate course of the curve by hand, and then lining in successively short pieces including three points, or four if possible, by means of "French curves" (Figs. 1 and 2), which are usually made of wood or ebonite, and may be obtained wherever drawing materials are sold.

Rulers made of thin steel with a lead backing, which can be bent into continuous curves of any description, are still better adapted for the purpose. They are used by architects, engineers, etc., and can easily be made from a suitable steel riband by laying a strip of lead along one edge and gently hammering it on. The lead serves to preserve the form of the curve, and the steel makes its course continuous and free from angles and breaks. A thin ruler is most suitable for strongly curved lines, a stout ruler for lines of gentle curvature.

One should make oneself familiar with such graphic methods by frequently using them, for they not only serve the purpose just specified, but are also important means of investigation in unknown territory.

Use of Corrections.—If the corrections of a scale have been determined, we must then add to each reading from it the values of the correction at the given place, due regard being had to sign. The sign is so chosen that the addition of the correction to the reading of the instrument gives the proper value. For instance, if the values read off are smaller than the true values, the correction is noted down as being positive.

If the corrections have small values, it is best, when it can be done, to mark them at their proper places directly on the scale. When this is impossible, they are written down on a strip of paper or thin cardboard which is brought alongside of the instrument, so that the corrections are found at the corresponding divisions. Thus if a burette is to be corrected, it is laid on the table, and beside it a strip of thick paper 2 cm. broad and of the same length as the burette; at each cubic centimetre division the corresponding correction is written down on the paper. When the burette is in use, the strip is hung up in the proper position beside it, and every reading before being noted down is reduced to the true value by means of the correction. If we desire to guard against accidental errors, the direct and the corrected readings may both be noted, so that they can be checked later if necessary. In specially important measurements this precaution should be observed, but in ordinary work it can mostly be dispensed with.

If greater care is to be taken with the corrections, the direct readings are noted and the adjustment of the correction made afterwards by means of the curve.

Multiple Corrections.—When there is on the scale of an instrument a zero-point which is otherwise arbitrary—as, for example, on a metre measure or a divided circle—the error of the zero is made equal to nothing, and all deviations are referred to it on this assumption. In some cases, however, the first and last points are otherwise defined. The errors of division are first determined with reference to the zero-point, then the absolute error of the zero-point is found and added algebraically to the others.

In other cases the zero is arbitrary but the end-point strictly defined. There must then be added to all intermediate corrections amounts which increase proportionally to the distance from the zero and form corresponding fractions of the correction for the end-point.

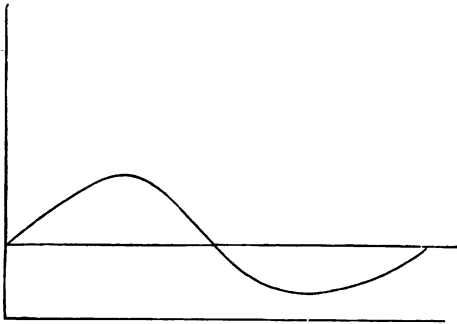

FIG. 3.

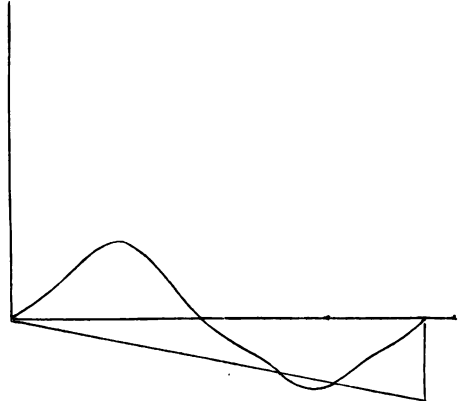

FIG. 4.

If both first and last points have special corrections, then to every value there must be added the correction of the zero-point plus a fraction of the difference of the corrections of the first and last points proportional to the distance of the value from the zero.

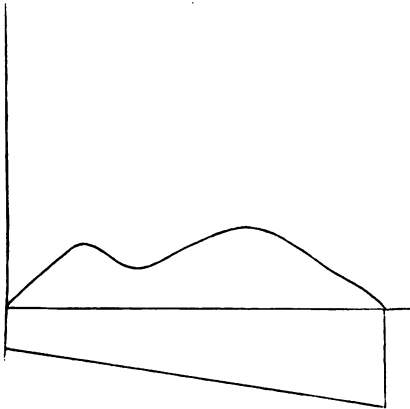

FIG. 5.

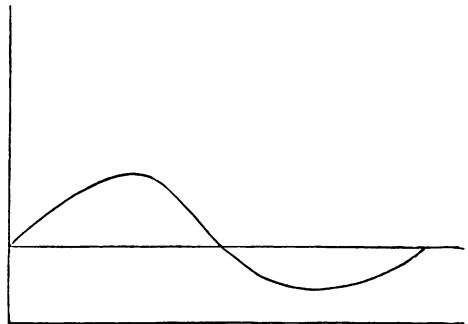

FIG. 6.

In graphic interpolation these additions come out as movements of the axis of abscissæ of the curve of relative corrections. In the first case the axis is shifted parallel to itself (Fig. 3); in the second it

is rotated round the intersection of the axes until the end-point falls on the proper value (Fig. 4); in the third case there is both translation and rotation (Fig. 5).

Since reading off the correction from the new axis of abscissæ would be inconvenient, as the sum of two separate readings would have to be formed, it is far better first to determine the new axis of abscissæ and tabulate the errors with respect to it; the final corrections are then read off directly from the usual zero-axis. Figs. 3-5 then take the form given in Figs. 6-8. The summation of the two corrections is thus done once for all.

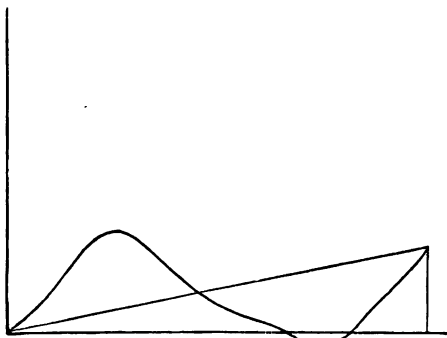

FIG. 7.

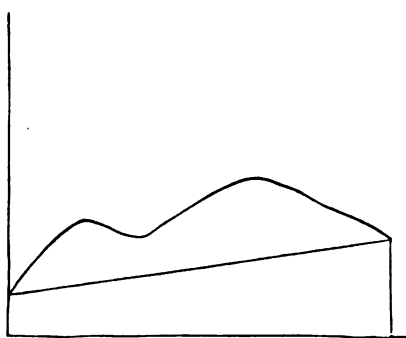

FIG. 8.

Rules for Arithmetical Computation.—Calculations are generally made to a decimal place more than the accuracy of measurement demands. In additions and subtractions only the absolute values of the errors are of importance; in multiplications and divisions the relative values. The error of the result is thus determined by the greatest error of the terms and factors involved. For instance, if two distances are to be added, one of which is known to be 205·3 cm., the other 0·2829 cm., we should not take the sum to be

$$\begin{array}{r} 205\cdot3 \\ 0\cdot2829 \\ \hline 205\cdot5829 \end{array}$$

but should take 205·6 as a final result, or 205·58 for purposes of further calculation. The number of places in an experimental result should always be made to indicate the limit of error by the last figure being uncertain, the second last certain. Only for more extended work requiring careful calculation should another place be taken, and even in that case the result should be shortened as above.

In multiplication and division we get numbers which are only as accurate as the least accurate of the factors. It is, therefore,

simply misleading to perform a complete multiplication in the ordinary way, as at most only half of the figures in the product can be used. If, for example, the radius r of a circle is 3.25 cm., the circumference is equal to $2\pi r$ or $2 \times 3.14159 \times 3.25$. Two of these factors, 2 and 3.14159, are without error, since they are absolute numerical coefficients, but 3.25 has, according to the above rule, an error of several units in the last place. Consequently the product of the three numbers will be correct to several units of the third significant figure, and all further figures are superfluous. Instead, therefore, of calculating the product out to be 20.420335, we should take $\pi = 3.14$ and make the product 20.4; anything more is objectionable, except in the case of long calculations, when we may use another figure, thus 20.42.

This mode of calculation is exemplified when we make use of logarithms, for we always employ logarithms with one place more than the number of significant figures we desire.

If we multiply in the ordinary way, we always obtain too many figures, which can be avoided by using shortened multiplication. The same thing holds for division.

If we have found, for example, a deflection of 235.6 mm. on a galvanometer scale, and know that a volt gives a deflection of 184.3 mm., the electromotive force can be calculated to four significant figures. The necessary division is then performed as follows:—

	Ordinary Division.
184.3)235.6(1.278	184.3)235.6(1.278
184.3	184.3
<u>51.3</u>	5130
36.9	3686
<u>14.4</u>	14440
12.9	12901
<u>1.5</u>	15390
	14744
	<u>646</u>

At each division one figure less of the divisor is used than at the previous one, the last (right-hand) figure of each product being obtained by rounding off the next figure mentally.

Multiplication is performed in the same way, the figures of the multiplier being taken from left to right instead of the other way as usual. An example will render further explanation unnecessary.

	Ordinary Multiplication.
28·341	28·341
552·69	552·69
14170·5	14170·5
1417·1	1417·05
56·7	56·682
17·0	17·0046
2·6	2·55069
15663·9	15663·78729

The acquirement of this mode of calculation cannot be sufficiently recommended. The ordinary method must be termed unscientific.

Some care is needed in fixing the number of significant figures. If we have, for example, 9.3×1.45 , we must not give the product strictly according to rule with two figures as 13, but with three as 13.5. For should the error in the number 9.3 be a unit, then by shortening the product from the full value 13.485 to 13 we should make an error in the result of 3.6 %, much greater than the original error, 1.1 %. The rule, therefore, for retaining the smallest number of significant figures should only be followed if the first figure of the result is greater than the first figure of the least accurate factor ; if it is smaller, another place must be added. The same holds good for division.

Noughts before the value in decimal fractions are not counted as significant, *e.g.* 0.000058 has only two significant figures ; but they should be written at the end of the number if they are the result of calculation or measurement. The number of 3.200 indicates that the value is known to a few thousandths, while 3.2 means that the error may amount to several tenths.

Aids to Calculation.—A great number of methods of measurement are of such a sort that the direct reading is proportional to the value to be measured, either directly or after the addition of a constant. Consequently multiplication and division are incessantly recurring operations, the rapid and convenient performance of which is a matter of some importance.

The first and most general aid is a table of logarithms, of from four to seven places according to the degree of accuracy required. In almost all cases a four-place table is sufficient, and if one has become accustomed to add and subtract the logarithms mentally there is scarcely a more convenient aid, for the whole table may be printed on two octavo pages and thus be looked through at a glance.

If we have many numbers to multiply by a constant factor, it is convenient to write the logarithm of the latter on a separate slip of paper and place it above the values of the logarithm of the variable factor, so that the addition may easily be made mentally. In divisions of this sort it is better, instead of subtracting, to add the decadic complement of the logarithm of the constant divisor. It is best

during the logarithmic calculation not to trouble with the characteristics at all, but only to calculate with the mantissæ, checking the result mentally by a calculation in round numbers which gives the place of the decimal point.

Slide Rules.—The application of logarithms in the form of a slide rule is also extremely convenient. So far as I know only small pocket apparatus for technical purposes are to be purchased, their accuracy being insufficient for most scientific applications. It is possible, however, with very little trouble to construct such an instrument which will still be of manageable length (about 1 metre) while possessing a greater accuracy than 1 : 1000, so that it may be used in most calculations.

The principle of such instruments consists in the numerical values of the logarithms from 1 to 10 being measured off as lengths on two rules, the divisions being marked with the numbers to which the logarithms correspond. To obtain the product mn , the division 1 of one rule is brought opposite the division m of the second, and we find on the latter the number expressing mn opposite the division n on the first rule. By this operation the logarithm of n is added to the logarithm of m (both being expressed as lengths) and the place on the second rule opposite n corresponds to the sum of the two logarithms, so that the number there found is the value of the product mn . If the numbers to be multiplied do not lie between 1 and 10, the multiplication is performed without regard to the decimal point, which is afterwards inserted by making a rough mental calculation.

The division $\frac{m}{n} = q$ is performed by placing the division 1 on the first rule opposite the division for the divisor n on the second, and then finding on the latter the position of the dividend m , opposite which on the first rule there is the quotient q , as we may easily see by noticing that we have made $\log m = \log n + \log q$.

If the slide rule is only divided once from 1 to 10, the products of factors containing a decimal place extra are not to be found opposite the second factor; though we can calculate 2×3 and 3×3 in the above way, we cannot perform the operation 4×3 . In the case of small slide rules the primary scale therefore is made to run on into a second similar one, with the result that a second series of logarithms with the characteristic 1 is given (the characteristic of the first series being taken as 0), so that all numbers up to 100 fall into one series, and all products up to $9 \cdot 9 \dots \times 9 \cdot 9 \dots$ can be ascertained. In the case of more exact and therefore longer slide rules this doubling of the length would be inconvenient, and may be all the more readily dispensed with, as we can use single length slide rules to find such products.

In order to ascertain the value of a product mn which has one place before the decimal point more than its factors, we set the last

instead of the first division of the first rule opposite the division m on the second, find n on the first, and opposite this the value of the product mn . We can see that this process is correct by imagining the second rule to be continued backwards by a reproduction of itself. In that case, if the end-point of the first rule is at m , the starting-point will also be at m on the imaginary scale.

We proceed in the same way when the first figure of the divisor is greater than the first figure of the dividend, so that the quotient has one place less than either. To find $\frac{m}{n} = q$, the last division of the first rule is set opposite the divisor n on the second, on which we then find the dividend m , and opposite to it the quotient required. The reasoning is the same as in the case of multiplication.

Construction of a Slide Rule.—To make a slide rule it is first of all necessary to have a primary scale from which the scale for use should be copied by means of the beam compass. The primary scale is made on a glass tube, and comprises the divisions for the logarithms of 1 to 2.5 at intervals of 0.005, *i.e.* the logarithms of 1, 1.005, 1.010, 1.015 . . . 2.490, 2.495, 2.500—601 divisions in all. The logarithms of these numbers are 0.00000, 0.00217, 0.00432, 0.00647 . . . 0.39620, 0.39707, 0.39794. The length is now determined which is to serve as the unit of the logarithm; suppose it is 80 to 100 cm., which will be found convenient. In modern dividing engines (p. 22) one turn of the screw is usually equal to 1 mm., *i.e.* in this case equivalent to a change of 0.001 in the logarithm. Since the difference between the logarithms of 1.000 and 1.005 is 0.00217, it follows that the first divisions are 2.17 mm. apart; the last divisions for 2.495 and 2.500, on the other hand, are only distant 0.87 mm. from each other.

The tube is fixed on the platform of the dividing engine, the length of the marks is regulated to about 1 cm., and the division performed according to the accompanying table (p. 18). If the screw has a pitch between 0.07 and 0.1 cm., the numbers in the table can be counted directly as turns of the screw, if not, the numbers must be multiplied by the corresponding factor.

The slide rule itself consists of two straight strips of wood somewhat over 1 m. long, 1.5 cm. broad, and 0.5 cm. thick, on one side of which

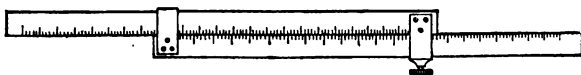

FIG. 9.

smooth drawing paper is pasted. These are so fastened together by means of two sheet metal collars lined with leather or cloth, that they can be moved lengthwise with respect to each other. Each strip carries one of the collars fixed at its end through which the other strip slides, as is shown in Fig. 9.

TABLE FOR THE DIVISION OF A SLIDE RULE

0·00	79·18	146·13	204·12	255·27	301·03	342·42	380·21
2·17	80·99	147·68	205·48	256·48	302·11	343·41	381·12
4·32	82·79	149·22	206·83	257·68	303·20	344·39	382·02
6·47	84·58	150·76	208·17	258·88	304·28	345·37	382·92
8·60	86·36	152·29	209·52	260·07	305·35	346·35	383·82
10·72	88·14	153·81	210·85	261·26	306·43	347·33	384·71
12·84	89·91	155·34	212·19	262·45	307·50	348·30	385·61
14·94	91·67	156·81	213·52	263·64	308·56	349·28	386·50
17·03	93·42	158·36	214·84	264·82	309·63	350·25	387·39
19·12	95·17	159·87	216·17	266·00	310·69	351·22	388·28
21·19	96·91	161·37	217·48	267·17	311·75	352·18	389·17
23·25	98·64	162·86	218·80	268·34	312·81	353·15	390·05
25·31	100·37	164·35	220·11	269·51	313·87	354·11	390·94
27·35	102·09	165·84	221·41	270·68	314·92	355·07	391·82
29·38	103·80	167·32	222·72	271·84	315·97	356·03	392·70
31·41	105·51	168·79	224·01	273·00	317·02	356·98	393·58
33·42	107·21	170·26	225·31	274·16	318·06	357·93	394·45
35·43	108·90	171·73	226·60	275·31	319·11	358·89	393·33
37·43	110·59	173·19	227·89	276·46	320·15	359·84	396·20
39·41	111·27	174·64	229·17	277·61	321·18	360·78	397·07
41·39	113·94	176·09	230·45	278·75	322·22	361·73	397·94
43·36	115·61	177·54	231·72	279·89	323·25	362·67	
45·32	117·27	178·98	233·00	281·03	324·28	363·61	
47·27	118·93	180·41	234·26	282·17	325·31	364·55	
49·22	120·57	181·84	235·53	283·30	326·34	365·49	
51·15	122·22	183·27	236·79	284·43	327·36	366·42	
53·08	123·85	184·69	238·05	285·56	328·38	367·36	
55·00	125·48	186·11	239·30	286·68	329·40	368·29	
56·90	127·10	187·52	240·55	287·80	330·41	369·22	
58·81	128·72	188·93	241·80	288·92	331·43	370·14	
60·70	130·33	190·33	243·04	290·03	332·44	371·07	
62·58	131·94	191·73	244·28	291·15	333·45	371·99	
64·46	133·54	193·12	245·51	292·26	334·45	372·91	
66·33	135·13	194·51	246·74	293·36	335·46	373·83	
68·19	136·72	195·90	247·97	294·47	336·46	374·75	
70·04	138·30	197·28	249·20	295·57	337·46	375·66	
71·88	139·88	198·66	250·42	296·67	338·46	376·58	
73·72	141·45	200·03	251·64	297·76	339·45	377·49	
75·55	143·01	201·40	252·85	298·85	340·44	378·40	
77·37	144·57	202·76	254·06	299·94	341·43	379·31	

The glass tube with the primary scale is fixed on two supports, and the closed slide rule, on which the division is to be made, fixed in the prolongation of its axis. By means of a beam compass (p. 26) the marks are transferred simultaneously to both parts of the slide rule, the divisions being so drawn that the corresponding marks meet on the line of contact of the two strips (Fig. 10).

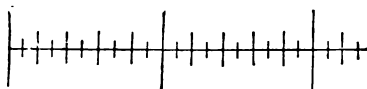

FIG. 10.

The dividing is carried out by first setting off the logarithms of 1.00 to 2.00, *i.e.* 201 marks. The slide rule is then brought nearer to the glass scale, and the beam compass so adjusted that the first mark of the scale corresponds to the last mark on the slide rule. The whole primary scale from 1.0 to 2.5 is now transferred to the rule, the fives and tens being marked, not as before, at every tenth and twentieth division, but at every fifth and tenth. This is on account of the differences of the logarithms from 2.0 to 5.0 being only half as great as the differences of the logarithms from 1.0 to 2.5. We can therefore use the same scale by giving each interval twice the former value. In this way we get as far as the logarithm of 5.0. The slide rule is once more brought nearer the glass scale and the beam compass adjusted so that one point is at 1.25 on the scale, while the other is at the last mark on the rule. The division is then completed by drawing every fifth stroke long; for now each interval on the rule has four times the original value, so that between 5.0 and 5.1 there are only five marks, just as there are between 1.250 and 1.275 on the scale.

This somewhat troublesome mode of dividing must be resorted to from the necessity of having the intervals to a certain extent uniform. If we retained the original difference of 0.005 units of the number, the last divisions would only be 0.22 mm. apart, an interval which, in the circumstances, could neither be set off nor read. By doubling the interval twice, the smallest distance becomes 0.87 mm., which is a practical length for reading.

The scale when completed has the form *a* (Fig. 11) between 1.0 and 2.0, *b* from 2.0 to 5.0, and *c* from 5 to the end. The numbers are now written in and the slide rule is ready. It stands a good deal of use, and may be cleaned with india-rubber when dirty.

It should be mentioned in conclusion that it is very convenient to have a new scale beyond the point 10, reaching perhaps to 15 or 20, as this frequently saves shifting the slide rule back. For this purpose the strips of wood must, of course, be chosen correspondingly longer.

Logarithmic Calculating Tables.—A very ingenious application of the principle of the logarithmic slide rule is to be found in the calculating table made by J. Billeter of Zürich. Imagine a slide

rule divided into several equal parts, and these placed one above the other in the form of a horizontal grating, so that all the parts of each scale move simultaneously. We get in this way the advantage of a

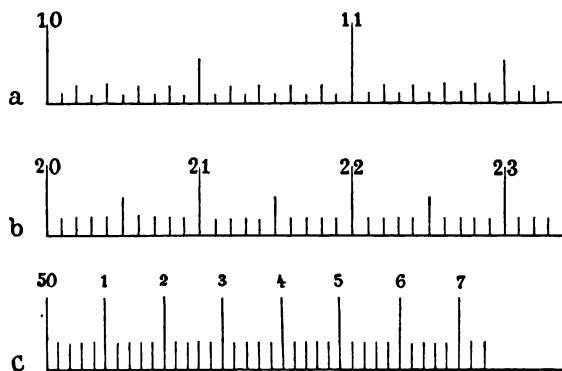

FIG. 11.

great decrease in length, the corresponding increase in breadth being no disadvantage.

The thing is carried out practically by having the scale corresponding to the upper rule on a flat surface, the scale of the lower rule being pasted on the under side of a glass plate provided with handles. The glass plate is placed on the lower table according to the rules given on p. 16. In order to obtain all the products of the factors shown without displacing the glass plate, the following arrangement is adopted:—Instead of the simple divided logarithmic scale a quadruple one is used, which we may imagine to be derived by placing a second scale to the right of the first and one line above it, and then under each of these another scale. In this way every factor occurs four times on the table, and there is always one position for it where the glass plate does not overlap the table at any part, so that all products containing it can be read off directly.

This is the most practical of the various forms of logarithmic slide rules, as it admits of great accuracy whilst being of small dimensions.¹ A table 15×27 cm. has fifty divisions between 1.0 and 1.1, *i.e.* is divided directly to 0.002, so that by estimating fourths we can calculate to a half pro mille. The only thing preventing the general introduction of this table is its high price, which bears no relation to the cost of constructing the simple apparatus.

Other Aids.—Besides the application of logarithms in various forms, use may be made of other calculating tables, which are methodically arranged products of two and three place numbers.

¹ Fuller's spiral slide rule will be found both accurate and convenient.—Tr.

Crelle's tables are in two volumes and contain the products of all three-place numbers. Handier, but less complete, are the tables of H. Zimmermann, which give the products of all three-place numbers with the factors 1 to 100. These tables are often very convenient, and can be more easily employed by persons weak in mathematics than tables of logarithms.

Finally, we may mention calculating machines, which also admit of rapid work. Their chief advantage, however, is only apparent with calculations to a great number of places. In multiplying a large series of numbers by the same factor—a calculation of everyday occurrence—they offer no special simplification, and in this respect are inferior to logarithms and calculating tables.

CHAPTER II

MEASUREMENT OF LENGTH

ALL measuring instruments are based on optical readings, and consequently involve linear division. In certain circumstances, as in the case of the balance, this division may be restricted within narrow limits, the greater part of the measurement being performed by counting the separate weights; but in most cases we have to deal with long scales comprising a large number of divisions. Angular measurements on divided circles are also ultimately dependent on the comparison of distances—namely, the lengths of the arcs corresponding to the angles.

The construction, testing, and reading of divided scales is therefore a constantly recurring operation in the metric sciences, and must be thoroughly understood before quantitative investigations are undertaken.

The scientific standard of length now universally adopted is the metre, which is defined as the distance between two marks on a platinum-iridium rod preserved in Paris. Most civilised states possess accurately investigated duplicates of this standard. Existing measures can be compared with the standard metre through the proper official authorities.

For scientific purposes the centimetre (cm.), or hundredth part of the metre, is most generally adopted as unit of length.

The Dividing Engine.—The dividing engine consists of a horizontal screw, by means of which a carriage can be moved along a parallel prismatic guide, and of marking gear fixed to the body of the machine. These two parts sometimes change places, so that the bed is stationary and the dividing gear movable. The instrument is almost indispensable in a physico-chemical laboratory.

Every screw has "back-lash," *i.e.* the adjustment with the screw is different according as the last turn of the screw has been made to the right or to the left. In the dividing engine the back-lash is usually considerable on account of the size of the carriage, so that the first rule for its use must be always to set it by turning to the

right.¹ Should we by chance overstep the mark, we must make at least half a turn backwards and repeat the adjustment in the proper direction. In buying a dividing engine it is best to procure one with a pitch as nearly as possible equal to a millimetre; a great deal of labour may be saved by this. The head of the screw is divided into 100, and thus gives a direct reading of 0.01 mm., and 0.001 by easy estimation.

The dividing gear has an arrangement for making long or short lines at will. As a rule, in the construction of scales two lengths are sufficient, every fifth mark being longer

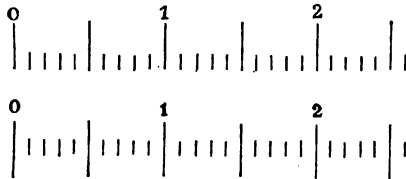

FIG. 12.

than the others. The tens need not be specially marked, as they are easily recognisable by the figures. Such a scale has the appearance shown in Fig. 12. In general it is convenient to make the unit lines rather short.

For marking brass, ivory, silver, and the like we should use a steel graver with a slanting edge, which is moved point first, as is shown in Fig. 13, which also indicates how the cutting is lifted out.

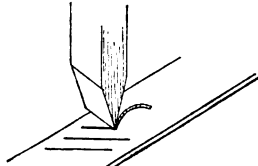

FIG. 13.

The pressure is regulated by weighting according to the hardness of the material and the breadth of line required. The graver should be as hard as glass, so as to alter its edge as little as possible during work. When blunt it may be sharpened by whetting with petroleum on an Arkansas hone.

Scales on Glass.—For making scales on glass, the most common of all, we may choose between the diamond and hydrofluoric acid. The diamond gives finer lines with proper adjustment, and should be used in the case of micrometer scales. It has the disadvantage, however, of making the glass very liable to crack or break, and should therefore never be employed for making scales on glass tubes to be exposed to any considerable changes of temperature. A common writing diamond is fixed in the dividing gear in place of the graver, care having been taken to ascertain the proper position and loading of the diamond from preliminary trials.

Graduations on glass are much more easily made by means of hydrofluoric acid, and the etched portions do not tend to break. In this case the lines are made with a steel point, not so hard, however, as to cut glass, and only lightly weighted.

First of all, the object to be graduated is warmed and then

¹ By a turn to the right is meant a rotation in the direction of the hands of a watch.

covered with a coating of melted wax. Yellow bees'-wax (not white or pale yellow) answers this purpose very well, but vegetable or mineral wax may also be used. It is well to add a little dark oil-colour to the melted wax (I use Prussian blue in tubes) so as to judge easily of the thickness and uniformity of the coating. The wax is spread on by means of a camel's-hair brush, or a wad of cotton wool fixed to a wire.

When a good coating without breaks or lumps has been obtained, an operation which requires a little practice, the object after cooling is fastened on the carriage of the dividing engine, great care being taken that it lies exactly parallel to the screw, and cannot in any way be displaced by the loaded graver. The graduation is then begun. If an error is made, it is best to take the object out and draw it through a flame so that the wax is for an instant melted and the lines run together. The division is then recommenced. With some practice it is possible to avoid lumps in this way; if any do appear, the coating operation must be repeated.

When the graduation is finished, figures and other marks have often to be added. These are marked on most conveniently with a clean, hard, fine-nibbed pen. For very fine lines a stout sewing-needle mounted in a holder may be employed. After the lines have been made it must be seen if they have penetrated the wax completely, and leave a shining glass surface exposed.

Etching on Glass.—In order to etch in the marks, the scale is washed over with concentrated hydrofluoric acid by means of cotton wool fastened to a piece of wire. Crude commercial fuming hydrofluoric acid should be employed. The washing is repeated twice when deep lines are required, and the acid is then washed off, care being taken not to bring the hands, especially the finger-tips, into contact with it. The scale is then dried and the wax coating removed by warming.

Concentrated hydrofluoric acid etches clear sharp lines with a bright surface into glass, whilst the vapour of the acid gives dull lines. For laboratory purposes the bright etching may be mostly adopted, the liquid acid being preferable to the gaseous, both on account of the rapidity with which it etches, and on account of the noxious properties of the latter. I employ it exclusively, and have convinced myself that distinct micrometer scales of 0.01 to 0.02 cm. can be easily obtained with it.

Sometimes the lines appear interrupted and not fully etched in. This comes from the needle not being sufficiently weighted, or more usually, from defective application of the acid. The cotton wool should be well soaked and moved backwards and forwards in the direction of the lines. The acid, however, flows so readily on the bare surface of the glass that there is always etching wherever the brush has reached.

If the lines show a tendency to flattening and broadening out at some places, the acid has either been chosen too weak, or the wax coating has been too thin. The proper thickness of the latter may be judged by the cold surface being dull and not transparent and shining.

To make the lines more visible, some colouring material should be rubbed in. Artists' colours in tubes mixed with a little drying medium, or printers' ink with gum dammar may be used. Writing-paper should be used for wiping off, as porous paper or linen takes the colour out of the lines again.

Testing the Dividing Engine.—The production of a proper screw for the dividing engine is a very difficult task if the error is to be less than 0.01 mm., but screws exact to several hundredths of a millimetre can be at present produced by mechanics without much trouble. To test the quality of the screw, a microscope is fixed to the body of the dividing engine, and on the carriage there is fastened a small steel rule (so that the expansion by heat may be equal to that of the machine), on which two fine lines, points, or other marks are made at any distance from 20 to 100 turns of the screw, as may be found convenient. This distance is measured in terms of the screw by bringing the lines in succession into coincidence with the spider thread of the microscope, back-lash being carefully avoided. The first portion at the end of the screw being thus measured, the rule is shifted along by about the distance between the two lines on it, which are again brought into position under the microscope; this process is continued until the whole length of the screw has been measured. Every adjustment must be repeated several times, say five.

In this way we can at once form a judgment of the quality of the screw, for the lengths ought to coincide to 0.01 mm. if the screw is good. To make a table of corrections, all the measured lengths are added together, the arithmetical mean is taken and the differences from the mean calculated, which are then the errors $d_1, d_2, d_3 \dots$ of the separate pieces. If the errors are added in the form $d_1, d_1 + d_2, d_1 + d_2 + d_3, d_1 + d_2 + d_3 + d_4$, etc., we get the corrections for the different places of the screw distant from each other by the length between the lines on the rule. From these values the curve of corrections is made as indicated on p. 11, from which the intermediate corrections may be interpolated.

Besides this simple method there are others more complicated which give us a much more intimate knowledge of the errors of the screw than can be obtained in the above way. We need scarcely consider them, however, as the dividing engine for our purpose is seldom required to be accurate beyond a few hundredths of a millimetre. Small lengths which have to be ascertained with greater exactness are measured, not with the long screw of the dividing engine, but with shorter screws or micrometers.

The constant or pitch of the screw is determined by measuring a known standard length, and dividing this by the corrected number of turns of the screw. If the pitch is very nearly a millimetre, the curve of corrections may be so constructed (pp. 12, 13) that the readings are reduced to true millimetres.

It need scarcely be mentioned that the correction curve can be used, not only for every measurement made with the dividing engine, but also for dividing correctly with a faulty machine. For this purpose the corrections for the adjustment are taken with the opposite sign.

Other Dividing Instruments.—In many cases the dividing engine may be replaced by simpler and cheaper instruments. If a millimetre scale is to be made, only a primary scale on a glass tube is necessary, which may then be transferred by means of a beam compass.

This very practical process, originally due to Bunsen, I execute as follows:—The primary scale, usually 50 cm. long, is made with a dividing engine on a tube of hard potash glass 1.5 to 2 cm. in diameter. This is fastened on two bridge-shaped supports (span 6.8 cm., height 2 cm.) at one end of a board fully twice as long as the scale. Parallel to the prolonged axis of the tube several lines are drawn on the board, which serve to determine the proper position of

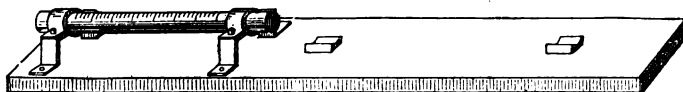

FIG. 14.

the object to be divided. Rules and similar objects are fastened down by bands and screws, or simply by means of adhesive wax.¹ Tubes lie in grooved cork supports pinned down to the board, and in this case also adhesive wax is usually sufficient for fixing (Fig. 14).

The graduation is copied by means of a beam compass (Fig. 15) made, for the purpose of convenient extension, of two rods whose

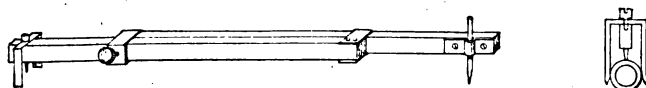

FIG. 15.

relative position can be fixed by tightening a screw. At one end the compass carries a short steel point which is placed in the grooved marks of the scale, and in order that the point may always remain in the middle of the tube, a forked guide is attached to the same end and grasps the tube, as is shown in Fig. 15. The other end of the

¹ A very useful mixture is made by melting carnauba-wax with a little vaseline.

compass is provided with a needle for etching on wax, or a drawing-pen for making scales on paper. With this arrangement scales on metal can only be made by etching (nitric acid on wax coating), as the drawing of lines by means of a graver needs too great an application of pressure.

Some practice is required in performing the graduation, the left hand regulating the adjustment of the steel point in the grooves, while the right draws the divisions freely and without pressure. Special arrangements for regulating long and short strokes may be dispensed with. On glass tubes the highest line is taken as guide, and the unit marks are made rather short. The lengths of the marks on paper scales may be determined by pencil lines drawn parallel to the long edge.

Arbitrary Units.—By means of the arrangements described above only millimetres or their multiples can be produced or transferred. The problem, however, may be to divide a given distance into a given number of parts, or to make divisions at other intervals than whole millimetres. In such cases other means must be adopted.

Bunsen has proposed for this purpose a system of convergent lines etched on glass,

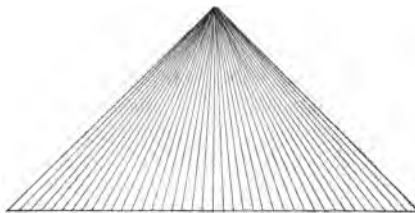

FIG. 16.

which divide a straight line into equal parts (Fig. 16). If a straight-edge is placed over the convergent system parallel to this straight line, a similar division is obtained on a correspondingly reduced scale. This arrangement has the disadvantage of the lines cutting the straight-edge at different angles, the adjustment of the point of the beam compass being thereby made in slightly different ways with the result that the transference is inexact. It is

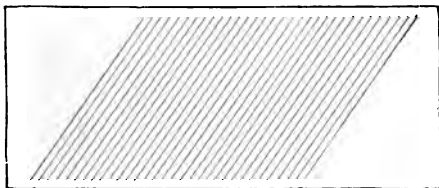

FIG. 17.

therefore more rational to use a plate on which parallel lines are etched at equal distances apart (say 0.5 mm.) If the straight-edge is laid on the plate in any direction, a correspondingly enlarged scale is got, and the beam compass falls in at each line under the same angle. It is most convenient to rule the lines obliquely on a longish piece of plate glass, as is indicated in Fig. 17, so that the short diagonal is at right angles to the direction of the lines. I usually provide one side with lines half a millimetre, and the other side with lines a whole millimetre apart. This is sufficient for all

cases, for on scales with divisions under 0.5 mm. the error of copying with the beam compass becomes quite considerable.

The plate is laid under an iron straight-edge faced beneath with leather, and the two are made fast with screws after adjustment to the proper position. The object to be divided lies in the prolongation of the straight-edge, the beam compass without the forked guide being used to transfer the marks. The point is held somewhat aslant and allowed to fall into the acute angles between the etched lines and the straight-edge.

Measurements of Length.—For ascertaining lengths, measures are used which, according to requirements, are divided into centimetres or millimetres. In the laboratory we may use for rough purposes wooden measures, which are to be had at very reasonable prices and are quite respectably accurate; the best of a small lot should be selected.

For somewhat finer measurements (to 0.1 mm.) millimetre scales on glass are best, the divided side lying on the object to be measured. The estimation of tenths of a division must be practised until some degree of certainty is attained.

In many cases, *e.g.* the measurement of the diameter of cylinders, contact between the scale and the points to be read cannot be made, so that recourse must be had to instruments for transferring the length to the scale.

The simplest is the mechanical transference by means of compasses. The ordinary compass is used for short lengths, and the beam compass for greater distances. The former is not usually provided with a micrometer motion, although this would in all cases make the work lighter and more accurate. Fig. 18 shows how one limb can be made susceptible of delicate adjustment by means of a screw working against a strong spring. On the better sort of beam compasses one of the points has usually fine motion.

The length to be measured is taken off on the compass, which is then applied to the scale. For such purposes an etched milk-glass scale is specially convenient, as the reading is very easy and the scale is not scratched by the compass points, as wood or metal would be.

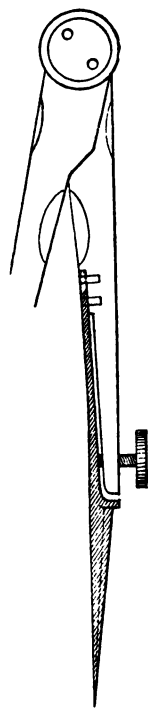

FIG. 18.

For cylinders, compasses with curved legs or turned-in tips, called callipers, are used. The transference is often made optically by providing the scale with a movable microscope or telescope, and reading off its position on the scale when the two points appear at the cross threads. The assumption is here made that the motion of the optical instrument has taken place in such a way that the axis has

always remained parallel to itself. Since this condition is never strictly fulfilled, an error is introduced which increases proportionally to the distance of the scale from the object, as is seen at once from Fig. 19.

This error is called parallax, and there are several means of obviating it. One very frequently applicable is to bring the scale as near as possible to the object, and arrange the reading instrument so that it can be adjusted to the two successively by a rotation round an axis parallel to the scale. If the axis of rotation is made as long as practicable, it is not difficult to retain it

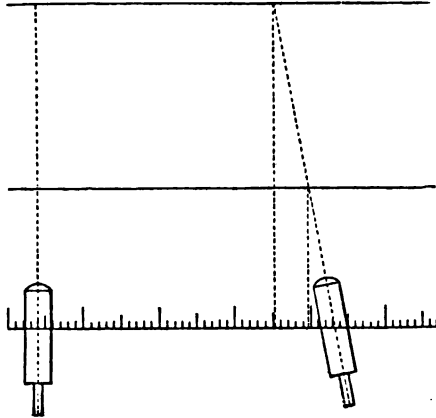

FIG. 19.

unchanged within much narrower limits than a parallel motion; axes turning on a conical point, even when only moderately well made, will be found useful. Besides, as we are always dealing with very small angular motions, any errors thus produced in the parallelism of scale and axis of rotation are only slightly hurtful.

Still more perfect theoretically is the principle of Abbe, who moves the scale in the prolongation of the object to be measured, and reads it off by means of a fixed microscope—once when it touches one point of the object, and again when it touches the other, or a plane support or stud against which the object rests. The parallel axis disappears here altogether, any residual error arising chiefly from defective guiding of the scale. This error gives as result the length multiplied by the cosine of the angle between the actual and theoretical positions of the scale, and even with the gross error of one degree gives 0.99985 instead of 1.00000, *i.e.* - 0.015 % of the measured length, an inconsiderable quantity.

From what has been said, it appears that the common method with the cathetometer is the least practical of all; this much-favoured instrument should never be used in such a way that the length to be measured is read off on the scale of the cathetometer itself, for besides the errors of parallax, due to imperfect parallelism, there are in the very frequently occurring cases of readings being made through glass plates or sheets of water, the deviations arising from refraction, which produce irregular errors amounting to as much as whole millimetres. These errors also disappear when the scale is brought as near the object as possible, and the reading made by rotation of the telescope. A cathetometer may be used for this

purpose, but a much simpler arrangement will serve (Fig. 20). This consists of a rod rotating on two points and having a movable telescope *F*, with a sensitive motion *M* attached. The axis of rotation is set accurately vertical by means of the screws in the tripod.

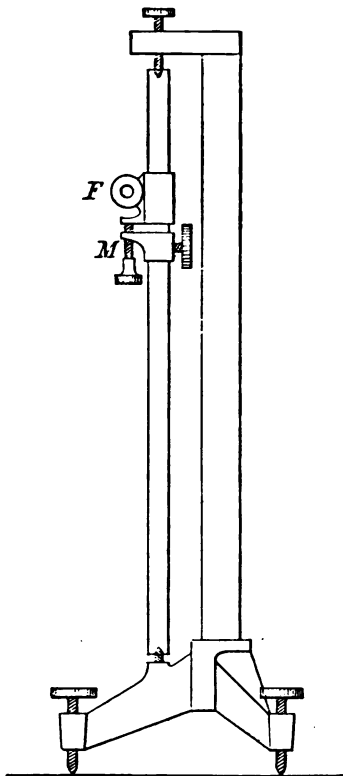

FIG. 20.

More exact measurements are made on the dividing engine with the help of a microscope, which may be movable and the object fixed, or *vice versa*, as best suits our convenience. Back-lash must be carefully avoided in such measurements.

Very small distances, *e.g.* the thickness of wire, foil, or glass, can be made to a few hundredths of a millimetre by means of the common micrometer screw or wire-gauge (Fig. 21), which is divided directly into tenths or twentieths of a millimetre, the hundredths being estimated. Before using the instrument it should be noted if the zero is at the proper place; if it is not, it is brought right by slightly moving the short screw opposite the chief one.



FIG. 21.

The Reading.—The most perfect reading, when the two magnitudes to be compared cannot be brought in immediate contact,

In some cases the optical adjustment may be simplified by mechanical means. Thus the diameter of a cylinder may be measured by placing it in a horizontal position and hanging over it a fine thread of unspun silk, or very fine soft wire, weighted at both ends. In order that the hanging threads may be parallel, the weights must be symmetrical and are best in the form of a solid of rotation with a vertical axis, for if the point of suspension is eccentric the threads will not be exactly vertical. The distance between the threads may be easily read off on a scale held behind them; it should be noted that the distance between the inner edges of the threads, and not that between their middle lines, is to be taken.

In the same way the horizontal distance between two points on a complicated surface may be often determined by this method of a suspended plumb-line.

is obtained when a real image of the point to be measured is brought into coincidence with the scale or mark, either by means of a telescope or compound microscope. The only precaution to be observed is to bring the image really into the plane of the cross threads or ocular micrometer. This is done as follows:—

First the front lens of the eye-piece is adjusted until the cross threads are distinctly visible without straining the eye. Then the image to be observed is sharply focussed by motion of the whole eye-piece, or body of the microscope. The eye is next moved crosswise in front of the eye-piece, to see if the image changes its position with respect to the cross threads. If it does, the second adjustment must be repeated until this is no longer the case. If the image is thrown out of focus by this, the final adjustment is made with the front lens alone.

In the plane of the real image there are either cross wires or a scale; the former make accurate adjustment possible, the latter can also measure small displacements. The second advantage may likewise be obtained if the cross wires are movable by means of a micrometer screw with a divided head, this giving the most perfect instrument. Such micrometer screws, however, are somewhat expensive, and necessitate a very firm setting up of the optical apparatus, so that it may not be displaced by the motion on screwing.

If the cross wires are to be adjusted to a line, they are used as in Fig. 22; it being observed if the corners of the triangles of 45° have the same height. If a scale is to be read off, one of the threads is brought into parallelism with the divisions (Fig. 23) and the tenths are estimated.

Readings with a magnifying lens are only free from parallax

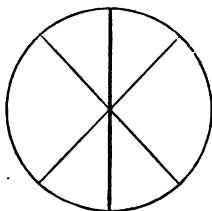

FIG. 22.

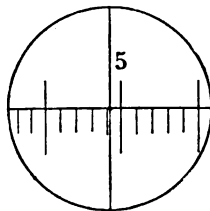

FIG. 23.

when the scale and mark are in the same plane. If this is not the case, *e.g.* in thermometer readings, special measures must be taken. The simplest way is to take advantage of the want of rectilinearity in the common lens, especially when the eye is at a little distance from it. A scale with straight divisions has then the appearance shown in an exaggerated manner in Fig. 24, and the lens is moved

until the division to be read off appears straight. An important detail is to have a small ocular diaphragm at a considerable distance from the lens, so that the position of the eye with regard to the latter may be adequately fixed.

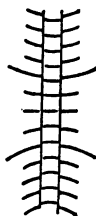

FIG. 24.

It is somewhat more convenient to have the lens combined with a pointer or sector which is adjusted to the point to be read. The pointer must not of course go beyond the middle of the visual field, else the reading would be disturbed. A diminution of the field by a sector is likewise practical when it is made so small that the position of the point in the centre can be judged by the eye without difficulty. If the field cannot be contracted, a transparent glass plate with a circle, or with two parallel lines, with respect to which the point read off is fixed, serves the same purpose. That the lines do not appear sharply defined at the same time as the point is rather an advantage than a disadvantage.

Vernier and Microscope.—If the mark (pointer, thread in eye-piece, etc.) is read off against a divided scale, it does not in general coincide with any scale-division. With practice the eye can easily be brought to estimate the tenths of the distance between two of them, and consequently we obtain one more decimal place than corresponds to the immediate division.

If a more accurate reading is required, the vernier may be made use of. To measure the n -th part of a division with this arrangement, the length of $n \pm 1$ divisions is divided into n parts, and the small scale thus obtained is used instead of an index, the zero being placed at the beginning in the case of $n - 1$, and at the end in the case of $n + 1$. The division on the vernier scale is sought out which lies in the same straight line as a division of the principal scale; let this be the m -th division of the vernier. Then the zero of the vernier lies $\frac{m}{n}$ units after the division it has just passed. In Fig. 25, $n = 10$, and the vernier is divided to correspond to $n - 1$. The division 3 of the vernier coincides with the opposite line, and the zero lies between 132 and 133 on the scale; the reading is therefore 132.3.

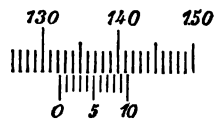

FIG. 25.

Fig. 26 shows on an enlarged scale another vernier which is often used to read circles divided into half degrees to minutes. In it 29 divisions are divided up into 30, so that the half degrees are divided into 30, and whole degrees therefore into 60, *i.e.* into single minutes. The double numbering on the vernier refers to whether the zero comes after a whole or a half degree on the scale. In the first case the upper series is used; in the second case there must be added to the number of the last whole degree $\frac{1}{2}^\circ$ or $30'$ plus the vernier reading, an addition which is performed by the lower series

of numbers. In the figure the vernier indicates $212^{\circ} 45'$. The extra divisions before the zero and after the n -th division serve to facilitate the observation of coincidences in the neighbourhood of these points.

Verniers are mostly divided for $n = 10, 20, 30,$ or 50 ; to go beyond $n = 50$ is not in general practical; it is better to make smaller divisions and a correspondingly shorter vernier.

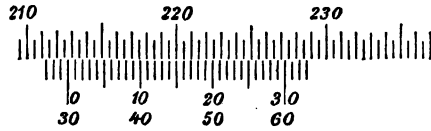

FIG. 26.

Besides the vernier there are still some other means for the fine division of given lengths. The most useful is the micrometer-microscope, which can be moved by means of a screw and carriage through measurable distances. If, as is usual, the screw has 20 threads to the centimetre and a head divided into 50 divisions, then each division corresponds to a motion of 0.001 cm., so that 0.001 mm. can be conveniently estimated. Of course the screw itself must be accurate to this extent.

The same rules apply to the manipulation of this micrometer as were given for the dividing engine. Measurements of the last degree of accuracy necessitate a very thorough study of the screw; for an account of such an investigation a text-book of practical astronomy may be consulted.

In many cases the reading may be effected with a microscope which has a divided scale in the eye-piece, a definite number of divisions on it corresponding to the unit of the principal scale. If this number is 10, then, by estimating tenths, we can read off to the hundredth of a division of the principal scale. A long focus microscope, with 10, 20, or 50 divisions in the eye-piece corresponding to 1 mm. on the object, is specially useful for this purpose. If the microscope is so arranged that the tube can be extended or shortened, such a simple ratio can be produced for any scale, *e.g.* for thermometers.

Measurements of Surface.—Determinations of the size of surfaces are only rarely required. In cases where a calculation from the geometrical form is not practicable, use is made of planimeters, which consist of a jointed system of levers, movable round a fixed axis, and provided with a tracing point and counting wheel. On going round the surface to be measured with the tracer, the wheel moves forward by an amount which is proportional to the contained surface, and this can be read off on the scale of the wheel.

A simple, though not a very accurate method, is to draw the figure on thick uniform paper, cut out, and weigh. By weighing a rectangular piece of the same paper with known sides, the factor is found for converting the weight into square centimetres.

More exact results are obtained by supposing the figure to be

divided up by parallel lines into strips of equal breadth, and measuring the length of the sides of these strips, or simply counting them if the figure is drawn on co-ordinate paper, as is mostly the case. If a_0 is the length of the first side, a_n of the last, and b the breadth, then the content is $b\left(\frac{a_0}{2} + a_1 + a_2 + \dots + a_{n-1} + \frac{a_n}{2}\right)$, each strip being considered a trapezium. The formula becomes more accurate the smaller b is made.

Measurements of Volume. — Measurements of volume are practically never made geometrically by measuring linear magnitudes, but in the vast majority of cases are reduced to weighings, 1 g. of water being made equivalent to 1 cc. Further information on this point is given in Chapter VIII.

CHAPTER III

WEIGHING

The Balance.—The balance is one of the most accurate and most useful means of measurement we possess. It is easy to weigh objects of 100 g. or even 1000 g. accurately to 0.001 g., *i.e.* to within 0.00001 or 0.000001 of their value, whilst the measurement of a length of 100 cm., for instance, to the same degree of accuracy, 0.001 to 0.0001 cm., necessitates the employment of very refined means, especially when two nearly equal lengths are not to be compared, but an arbitrary distance is to be measured. It is expedient, therefore, when a high degree of accuracy is aimed at, to reduce measurement as far as possible to weighing. This may be done by taking advantage of a number of important general principles, which show proportionality to exist between various magnitudes and the gravitation forces measured by the balance.

The balance is a two-armed lever and serves to measure forces acting on one of the arms by means of parallel forces acting on the other arm. These forces have their origin in the first instance in gravity and can be measured by the employment of weights. The chief application of the balance depends upon these forces, or the weights of material objects, being proportional to their masses, and in the case of one and the same substance to their volumes and to the amount of chemical energy they contain. Consequently the balance may be used for the determination of all these magnitudes.

Besides this field for the application of the balance, there is another in which, along with weight, other forces—electrostatic, electrodynamic, magnetic, etc.—are measured; but this latter field is much more limited than the former.

For exact measurements we have practically only to deal with such balances as are used in chemical analysis for a load of 100–200 g. The long-beam balances formerly constructed in deference to a mistaken prejudice are now being everywhere replaced by short-beam instruments. By the employment of a short beam and a sufficiently long pointer we secure various advantages, the principal

one being the shorter time of vibration and the increased lightness of the beam for the same degree of sensibility.

The beam is usually made of brass, occasionally however of aluminium or an aluminium alloy, in order to reduce the weight. It is provided with three sharp edges, which form the axis of the lever and the points of application of the forces. These must be made exactly parallel and must lie in one plane.

Steel used to be employed exclusively as the material for these "knife-edges," but now edges are also made of agate or flint. For some eight years I have been collecting data as to the behaviour of the latter, and can thoroughly recommend them, as they are not attacked by acid vapours or chlorine, and suffer little deterioration through time.

A serviceable balance must above all never change its zero-point when the arrestment is put on and off several times in succession, and when weights are placed on the pans and again taken off. Immediately after unpacking and setting up these conditions are usually not fulfilled; the balance therefore should be allowed to stand several days before being tested, so that it may settle into uniform conditions.

The zero-point is regulated by means of a small pennant usually placed near the top of the pointer. First of all the case must be set horizontally by means of its screws, in accordance with the indication of the plumb-line or circular spirit-level which generally accompanies it. The arrestment is taken off and the balance allowed to swing; three half swings are then observed, which should not exceed ten scale-divisions on either side of the zero. The mean of 1 and 3 is added algebraically to 2, and the mean then gives the zero of the pointer. Reading off the position of the pointer is much facilitated by the use of a large lens placed at a suitable distance and height in front of the scale, so that in the natural position of the head before the balance the enlarged virtual image of the pointer and scale directly meets the eye (Landolt). Microscopic reading of the pointer has also been occasionally applied, the size and duration of the swings being thereby considerably diminished, but such balances are still very seldom met with.

An important property of a good balance is seen during the observation of a series of free vibrations—the extent of the vibration should only diminish slowly. All these observations should of course be executed with the balance-case closed.

The equality of length of the arms of the beam is not an essential condition, provided we are accustomed to make all weighings for absolute weights by the method of substitution. A knowledge of the ratio of the lengths of the arms is only necessary in correcting the set of weights.

Weighing.—Every weighing consists of two observations. In

most cases we have to weigh a vessel from which something is removed, or to which something is added, and the magnitude required is the difference of the two weighings. If these weighings can be executed immediately after one another, we need not trouble about the zero-point of the unloaded balance. If this is not the case, the zero-point should be determined before or after each single weighing, so that the measurement is composed of four separate determinations.

To weigh with the least amount of calculation possible, the zero position of the pointer is not ascertained, but the deviations; those to the right of the zero of the scale being reckoned positive, those to the left negative, so that the numbers increase as is usual from left to right. The tenths are estimated and the decimal point need not be written down. The reading corresponds therefore to the values of the scale indicated in Fig. 27. The deviation is obtained from three observations by adding the mean of the first and third to the value of the second, due regard being paid to sign. Thus, if the pointer turns at 52, -43, 51, the deviation is $\frac{52 + 51}{2} = 51.5$, minus 43, *i.e.* 8.5. It is unnecessary to bring the deviation of the balance, without load, to zero; it is sufficient if it is less than ± 20 .

In weighing, the object is placed upon the left-hand pan, and the weights on the right-hand pan, in the order in which they follow each other, down to centigrams. The makers still furnish the sets with milligram weights, but these are quite unnecessary and might be omitted to save expense. The balance must be arrested each time weights are added or removed.

When equilibrium has been so far established by means of the set of weights that another centigram added is too much, the balance-case is closed, and the centigram rider moved on the divided beam, until it makes the pointer move to the right when on one of the decimal divisions, whilst on the next division it sends the pointer to the left. The vibrations are observed each time and the deviation calculated from them. According as it is necessary to take into account the zero position of the empty balance or not, the tenths of a milligram are interpolated between the observed deviations and either those of the empty balance, or the zero of the scale, while the whole milligrams are read off on the decimal scale of the beam on which the rider rests.

If a is the deviation with the smaller weight, b the deviation with 1 mg. more, and c the deviation of the empty balance, then $\frac{a - c}{a - b}$ milligrams must be added in order to obtain the true weight.

For example, let the observed values be as follows:—



FIG. 27.

	Swings.	∴ Deviation.
Empty balance	- 12, + 8, - 11	$c = - 3.5$
Loaded with 23.522 g.	+ 13, - 3, + 11	$a = + 9.0$
„ „ 23.523 g.	- 42, - 30, - 39	$b = - 10.5$

The fraction of a milligram will thus be $\frac{9.0 + 3.5}{9.0 + 10.5} = 0.64$, and the weight 23.52264 g.¹

Exact weighings made in this way should only be adopted when necessary, *i.e.* when it is certain that the object to be weighed is exactly defined down to tenths of a milligram. This case is of rarer occurrence than is generally supposed. Large glass vessels, india-rubber apparatus, platinum crucibles, and dishes in particular often change in weight by whole milligrams in consequence of condensation of moisture according to the state of the atmosphere. These things are therefore mostly kept in desiccators, and should be weighed as rapidly as possible, for the drying of the air in the balance-case by means of calcium chloride, etc., is rather illusory.

If the weighing is only to be accurate to a few tenths of a milligram, the process may be made considerably shorter. The sensibility of the balance, *i.e.* the deviation occasioned by a milligram overload, remains fairly constant with the time, and with good balances varies comparatively little with the load. This value is determined once for all, and brought for convenience sake to a whole number (10 or 20) by means of the gravity bob which regulates the sensibility. The determination of one deviation is then sufficient if the zero position is known, for the value $b - a$ used above is the sensibility, and if the deviation $c - a$ with respect to the zero position is known, dividing by the sensibility constant, gives the tenths of a milligram accurate to one or two units. To diminish the possible error, the fraction of a milligram to be added or subtracted should be less than 0.5.

Such weighings, which with some practice can be made very quickly, only give good results in expert hands. The beginner will do well to adhere to the more formal process until he has acquired certainty in using the balance.

Buoyancy of the Air.—As we have already said, the balance indicates the forces acting on the points of suspension of the edges; but besides the weight of the pans and their loads, other forces act upon the balance, the chief of them being due to the buoyant effect of the atmosphere.

If d is the weight of 1 cc. of air and v the volume of the object

¹ It is usually recommended to determine the equilibrium positions of the pointer. These are equal to half the deviations. The calculation then gives the quotient $\frac{a/2 - c/2}{a/2 - b/2}$ which is equal to $\frac{a - c}{a - b}$. This means making three superfluous divisions by 2, which are saved by adopting the method of the text.

weighed, the weight appears diminished by vd , and the true weight is $G + vd$, if G is the apparent weight.

The weight of 1 cc. of air at 0° and 76 cm. is 0.001293. At the atmospheric temperature d may be made equal to 0.00120, if the mean humidity of the atmosphere, which diminishes the weight, is taken into account. The volume of the substance is the product of its weight and its specific volume ϕ ; instead of which the reciprocal of the specific gravity $\frac{1}{s}$ may be used. Consequently $v = \frac{G}{s}$ and the true weight of the substance is $G + \frac{0.0012G}{s} = G \left(1 + \frac{0.0012}{s} \right)$.

On account of the small amount of this correction, the apparent weight G may be used in the expression $v = \frac{G}{s}$, although, strictly speaking, we ought to use the true weight. To be convinced of this, after we have calculated the true weight, we may substitute it in $v = \frac{G}{s}$, and we shall then find that no alteration in the significant figures is thereby effected. If the correction is 0.001, the correction of the correction will only produce an alteration of $(0.001)^2 = 0.000001$ in the final result.

If we wish to obtain absolute weighings, the same correction must be made for the weights themselves. But if, as is very often the case, only relative weighings are necessary, no attention need be paid to this source of error, for, by neglecting it, all the weights of the same material are affected in the same proportion, *i.e.* merely the unit of the set of weights is altered. For brass weights ($s = 8.5$) the correction is 0.00014, *i.e.* 0.14 mg. per gram. This amount is to be deducted from the calculated true weight if, as must always be assumed, the set of weights is correct in a vacuum.

Thus the true weight G_0 of a substance weighed with brass weights, its apparent weight being G , is

$$G_0 = G \left(1 + \frac{0.0012}{s} - 0.00014 \right) = G(1 + k).$$

Kohlrausch has calculated the following table for a series of different values of s , k being the correction in milligrams to be added to each gram of apparent weight:—

[TABLE

CORRECTION FOR LOSS OF WEIGHT IN AIR

s.	k.	s.	k.	s.	k.
0·7	+ 1·57	2·0	+ 0·458	8	+ 0·007
0·8	+ 1·36	2·5	+ 0·337	9	- 0·009
0·9	+ 1·19	3·0	+ 0·257	10	- 0·023
1·0	+ 1·06	3·5	+ 0·200	11	- 0·034
1·1	+ 0·95	4·0	+ 0·157	12	- 0·043
1·2	+ 0·86	4·5	+ 0·142	13	- 0·050
1·3	+ 0·78	5·0	+ 0·097	14	- 0·057
1·4	+ 0·71	5·5	+ 0·075	15	- 0·063
1·5	+ 0·66	6·0	+ 0·057	16	- 0·068
1·6	+ 0·61	6·5	+ 0·042	17	- 0·072
1·7	+ 0·56	7·0	+ 0·029	18	- 0·076
1·8	+ 0·52	7·5	+ 0·017	19	- 0·080
1·9	+ 0·49	8·0	+ 0·007	20	- 0·083

It is more rational to calculate at once with the specific volume instead of the specific gravity; for in any case the specific gravity is a less scientific conception, for in it the volume of the objects is made the variable, and not the mass or the weight. If $\phi = \frac{1}{s}$ is the specific volume, the equation for brass weights becomes

$$G_0 = G(1 + 0\cdot0012\phi - 0\cdot00014).$$

Whilst the relation of the correction k and the specific gravity is a function of the second degree, the relation between k and ϕ is linear, which is of considerable convenience in interpolation. The table corresponding to the foregoing equation is as follows:—

CORRECTION FOR LOSS OF WEIGHT IN AIR

ϕ .	k.	ϕ .	k.	ϕ .	k.
1·5	+ 1·66	0·9	+ 0·94	0·1	- 0·020
1·4	+ 1·54	0·8	+ 0·82	0·09	- 0·032
1·3	+ 1·42	0·7	+ 0·70	0·08	- 0·044
1·2	+ 1·30	0·6	+ 0·58	0·07	- 0·056
1·1	+ 1·18	0·5	+ 0·46	0·06	- 0·068
1·0	+ 1·06	0·4	+ 0·34	0·05	- 0·080
...	...	0·3	+ 0·22
...	...	0·2	+ 0·10

The corresponding curves of course show a like difference; the curve for s and k is greatly curved, whilst that for ϕ and k is a straight line (Fig. 28). More exact corrections than those given here will seldom be found necessary; even Stas contented himself with this mode of calculation in his atomic weight determinations. I do not therefore discuss them; persons who perform researches requiring such corrections will scarcely need this little book.

The Weights.—Every set of weights is affected with errors,

which, although small in carefully made weights, must be known and allowed for in anything like accurate work. The mode of correction here described is with slight alterations that given by F. Kohlrausch.

CORRECTIONS FOR A SET OF WEIGHTS

The task of determining the errors of a set of weights generally resolves itself into performing as many weighings as there are weights

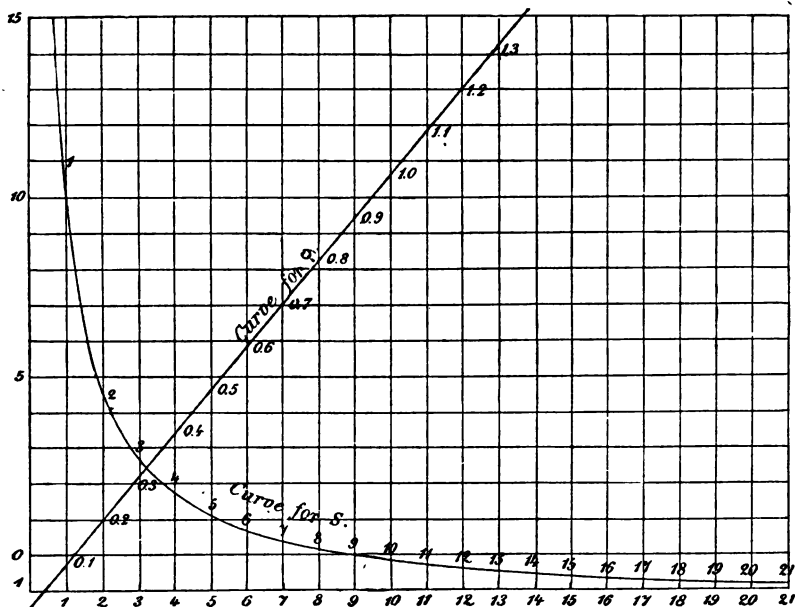

FIG. 28.

to be tested, so as to obtain an equal number of equations, from which the ratio of the lengths of the arms, and the ratios of the weights to each other may be calculated.

The following scheme may be adopted for the order usually found in a set of weights :—The larger weights are denoted by

$$50' \ 20' \ 10' \ 10'' \ 5' \ 2' \ 1' \ 1'' \ 1'''.$$

Perform a double weighing with 50' on the one pan and the sum of the other weights on the other. Suppose it is found that the pointer comes to the zero-point of the empty balance when we have

Left.	Right.
50'	20' + 10' + . . . + r mg.
20' + 10' + . . . + l mg.	50'

then the ratio of the arms of the beam is

$$\frac{R}{L} = 1 + \frac{l-r}{100000}$$

and

$$50' = 20' + 10' + \dots + \frac{1}{2}(r+l).$$

In the same way $20'$ is compared with $10' + 10''$, and $10'$ with $10''$ and with $5' + 2' + 1' + 1'' + 1'''$. In general the ratio of the arms will be found to vary somewhat with the load, but it will be so far constant as only to necessitate one weighing with the smaller weights. Then a weight p on the right-hand pan will, when reduced for the left-hand side, be equal to $p \frac{R}{L}$.

Example— Let $r = -0.63$, and $l = +2.73$ mg., then

$$50' = 20' + 10' + \dots + 1.05 \text{ mg.}, \text{ and } R/L = 1.0000336.$$

Suppose, further, that on comparison of the 5 g. weight with the sum of the smaller weights, we have

Right.	Left.
$5' + 0.31 \text{ mg.}$	$2' + 1' + 1'' + 1'''$,

then on an equal-armed balance the equilibrium would be as follows:—

or	$5' + 0.31$	$(2' + 1' + 1'' + 1''') \times 1.0000336,$
		$2' + 1' + 1'' + 1''' + 0.17 \text{ mg.}$

Consequently $5' = 2' + 1' + 1'' + 1''' - 0.14 \text{ mg.}$

Let the result of the several weighings be

$$\begin{aligned} 5' + 2' + 1' + 1'' + 1''' &= 10' + A \\ 10'' &= 10' + B \\ 20' &= 10' + 10'' + C \\ 50' &= 20' + 10' + 10'' + \dots + 1''' + D. \end{aligned}$$

We may suppose, as a first assumption, that the weight $10'$ is correct; then, if we express the other weights in terms of this, we have

$5' + 2' + 1' + 1'' + 1'''$	=	$10' + A$
$10''$	=	$10' + B$
$20' = 10' + 10'' + C$	=	$2 \times 10' + B + C$
$50' = 20' + 10' + 10'' + \dots + 1''' + D$	=	$5 \times 10' + A + 2B + C + D$
$10'$	=	$10'$
—		
Sum of weights	=	$10 \times 10' + 2A + 4B + 2C + D$

Now, if we wish to make the separate errors of the weights as small as possible, we must assume that the sum of all the weights is

correct, *i.e.* 100 g. exactly, and reject our first assumption of the accuracy of the weight 10'.

$$\begin{array}{l}
 \text{Putting} \quad S = \frac{1}{10}(2A + 4B + 2C + D), \\
 \text{we have} \quad 100 \text{ g.} = 10(10' + S) \\
 \text{or} \quad 10' = 10 \text{ g.} - S, \\
 \quad 10'' = 10 \text{ g.} - S + B \\
 5' + 2' + 1' + 1'' + 1''' = 10 \text{ g.} - S + A \\
 \quad 20' = 20 \text{ g.} - 2S + B + C \\
 \quad 50' = 50 \text{ g.} - 5S + A + 2B + C + D = 50 \text{ g.} + \frac{1}{2}D.
 \end{array}$$

The accuracy of the numerical calculation may be tested by the sum of the corrections, when expressed in numbers, amounting to 0 and by the four observed equations being satisfied.

Suppose, now, we find by comparison of the weights 5' 2' 1' 1'' 1''' amongst themselves,

$$\begin{array}{rcl}
 1' & = & 1' \\
 1'' & = & 1' + a \\
 1''' & = & 1' + b \\
 2' = 1' + 1''' + c & = & 2 \times 1' + b + c \\
 5' = 2' + 1' + 1'' + 1''' + d & = & 5 \times 1' + a + 2b + c + d
 \end{array}$$

$$\text{then, } 5' + 2' + 1' + 1'' + 1''' = 10 \text{ g.} - S + A \quad = 10 \times 1' + 2a + 4b + 2c + d$$

$$\text{i.e. } 10 \text{ g.} = 10 \times 1' + 2a + 4b + 2c + d + S - A$$

$$\text{or, if we make } s = \frac{1}{10}(2a + 4b + 2c + d + S - A)$$

$$10 \text{ g.} = 10(1' + s).$$

We thus have

$$\begin{array}{l}
 1' = 1 \text{ g.} - s, \\
 1'' = 1 \text{ g.} - s + a \\
 1''' = 1 \text{ g.} - s + b \\
 2' = 2 \text{ g.} - 2s + b + c \\
 5' = 5 \text{ g.} - 5s + a + 2b + c + d.
 \end{array}$$

The smaller weights are then dealt with in the same way, the inequality of the arms being, however, as a rule left out of consideration.

Till now we have assumed the sum of the larger weights to be correct in order to make the error as small as possible. For most work (chemical analysis, specific gravity) this is sufficient, as only relative weighings are required. If the table of errors is to be made with reference to the real gram, it is necessary to compare the weights, or one of them, with a standard weight. The calculation is similar to the above.

A scheme for testing a set of weights otherwise arranged may easily be constructed.

To distinguish between the various weights of the same nominal value, the numbers should either be stamped on in different ways or provided with an index; otherwise one must take advantage of accidental markings. Weights made of metal foil may be marked by turning over the different corners.

No attention need be paid to the loss of weight in air if the larger weights are all constructed of the same material, for the difference

in the case of the smaller weights is altogether inconsiderable. In testing the small weights a light balance should be used, *i.e.* one with great sensibility for a given period of vibration.

The weighings must be made by the method of vibration, and the zero-point frequently determined. If one becomes accustomed to use the weights in a definite order, each total weight will always be made up of the same pieces. It is easy, therefore, to calculate the table of corrections for total weights by dividing them according to hundredths, tenths, units, tens, etc.

From the circumstance that at a given spot mass and weight are strictly proportional to each other, the balance is the most accurate instrument for determining mass, although, as above mentioned, it only directly determines forces. As standard of mass we accept a cylinder of platinum kept in Paris, the mass of which is called a kilogram, the thousandth part of this, the gram, being adopted as the scientific unit of mass.

The gram was originally supposed to be equal to the mass of a cubic centimetre of water at 4° , but this relation is only approximately fulfilled, the error being about 0.01 per cent. Exact determinations of this relation have still to be made.

CHAPTER IV

MEASUREMENT AND REGULATION OF TEMPERATURE

The Mercury Thermometer.—Determinations of temperature have very frequently to be made, the mercury thermometer being almost without exception the instrument employed. The complete examination of this instrument is a difficult and tedious matter, but at present the experimenter is spared this work, as the authorities at Kew Observatory undertake the comparison of mercury thermometers with the air thermometer with every practicable degree of accuracy. We are thus in a position to have a corrected standard thermometer in every laboratory, with which the ordinary instruments may be compared, and even the private investigator will in general possess such an instrument. In this way the principal part of the preliminary work with the thermometer is reduced to comparing the instrument to be used with the standard thermometer, with perhaps an additional calibration correction.

The mercury thermometer has several peculiarities with which we must be familiar before employing it with certainty. Firstly, all glass after being heated to a high temperature retains a portion of the dilatation it has experienced, and this only slowly disappears after days or weeks. With ordinary glass the after effect of a temperature of 100° is -0.2° at 0° ; with Jena thermometer glass it is much smaller but still quite noticeable. According to Pernet the effect is approximately proportional to the square of the rise of temperature. A thermometer exposed to greatly varying temperatures must therefore, when exact measurements are required, be heated, not more than an hour before the readings, to a temperature above the highest temperature for which it is to be used; 100° is usually most convenient. The zero of the thermometer must then be referred to this state. If the measurements all fall within a few degrees, the thermometer may be used as it stands.

A second peculiarity, which may cause very considerable errors in the case of thermometers of fine bore, is stiction. A thermometer assumes at the same temperature a lower position when it is rising

than when it is falling. This comes from the capillary resistance experienced by the fine mercury column—a resistance which affects the elasticity of the bulb differently according as it produces a pressure one way or the other. According to Pfaundler's experiments the amount and irregularity of this error is much greater for falling than for rising temperatures; from which we deduce the rule that in the measurement of differences of temperature we must always arrive at the final state in the same direction, if possible with a rising thermometer. This may almost always be attained, *e.g.* by taking the instrument out of the liquid so that it may cool a little. By tapping the thermometer immediately before reading, the effect of stiction may also to a great extent be got rid of.

It is a case of frequent occurrence that the whole thermometer cannot be brought to the temperature to be measured, a larger or smaller portion of the stem remaining unheated. We must then calculate by how much the mercury column would be lengthened if it were all brought to the same temperature as the bulb. This correction is given in degrees by the expression $h(\alpha - \beta)(t - t_0)$, where α is the coefficient of expansion of the mercury, β that of the glass, h the exposed length of the column, t_0 its mean temperature, and t the temperature read off. For α we may put 0.000182; β for ordinary glass is 0.000029, for Jena thermometer glass 0.0000244. The uncertain part of the correction lies in the determination of the mean temperature of the exposed thread, for different temperatures are registered by a thermometer placed at only slightly different parts of it.

As other modes of correction are also more or less untrustworthy, it is best to avoid the error as far as possible, either by suitable arrangement of the experiment, or by the employment of short-scale thermometers (with a range of from twenty to fifty degrees), so that only a small portion of the mercury is exposed. Thermometers of this kind were introduced by Zincke for the determination of high boiling and melting points of organic compounds.

If we are only dealing with differences of temperature, not absolute values, the correction need not be applied at all, if care be taken to make the thread move in a space for which the temperature is not far from uniform.

The Freezing Point.—The safest and most convenient way of determining the zero-point is to place the thermometer in a test-tube provided with a wire stirrer, and three parts filled with pure water. This tube is sunk over the water-level in a mixture of ice and a little salt, and the water is cooled down to about a degree below zero. Ice then usually separates, and is kept as finely divided as possible by vigorous stirring.¹ The thermometer rises to the freezing point in the course of one or two minutes, and remains there steadily. This

¹ Beckmann's freezing-point apparatus (Chap. XIV.) is excellent for this purpose.

process is much to be preferred to the use of snow or pounded ice, as we cannot always be certain of the purity of these substances. It has also the advantage of the freezing point being reached with a rising thermometer (p. 46).

The Boiling Point.—To determine the boiling point Rudberg's apparatus (Fig. 29) is used. This may be improvised if necessary from a tin can with a second cylinder set inside (cf. Fig. 33, *a*, p. 53). The thermometer must be in the steam and not in the boiling water.

The boiling point of water depends on the atmospheric pressure, and should be reduced to the standard pressure of 76 cm. For every millimetre of mercury in the neighbourhood of 76 cm. the boiling point changes by $\frac{3}{80}$ of a degree. The upper end of the mercury column must project slightly above the boiling vessel, otherwise a somewhat rapid distillation of mercury into the top of the capillary takes place, thereby occasioning errors of considerable magnitude (Walter).

Calibration of a Tube.—To determine the error of bore occurring in every capillary, Hällström's method is the most convenient, for although theoretically not quite perfect, it gives sufficiently accurate results to meet the usual requirements. It is based on the use of two mercury threads, both of which are submultiples of the total length, and which differ from each other by the interval of calibration. For instance, if a thermometer ranging from 0° to 100° is to be calibrated for every five degrees, then threads 20° and 25° long will be used. If the tube has 300 divisions, and is to be calibrated for every 10, then 50 and 60 are chosen, and so on. I will describe the process for the most frequently occurring case, a scale divided into 100; the schemes for other cases may be easily evolved on the same lines.

First of all a thread of 20° has to be separated. For this purpose the thermometer is inverted and given a smart downward tap, the mercury column being thus set in motion. If a separation has taken place in the stem, the length of the severed thread is observed—let it be 33° . The lower end of the thread is now brought to a definite point, say 20° , and the thermometer is warmed until the mercury unites again with the separated portion. The temperature is next lowered to a point 20° above the point of union, *i.e.* to 40° , and the thread again broken by a smart blow. The break always occurs at the place on the scale where the threads had formerly joined, and therefore a thread 20° long breaks off, as intended. If the attempt is not quite successful, the process is repeated.

Sometimes the column does not break on the first inversion, but

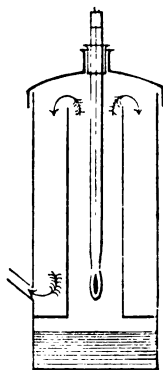

FIG. 29.

a vacuum is formed in the bulb instead. In that case the stem should be allowed to fill with mercury, and the thermometer be suddenly brought, with a tap, to its original position. The vacuous space then comes to the join of the stem and bulb. The thermometer is again inverted before all the mercury has flowed back, and again tapped; this separates a thread which is brought to the proper length in the way just described.

With the 20° column the readings 0-20, 20-40, 40-60, 60-80, 80-100 are now made, the thread being brought by careful inclination of the instrument and tapping as nearly as possible to the desired position, and both ends being read off. The reading is best done by laying the thermometer on two cork supports fastened to a board, and using a pretty strong magnifying lens, mounted on sufficiently long legs (Fig. 30). To avoid parallax the lens is placed so that

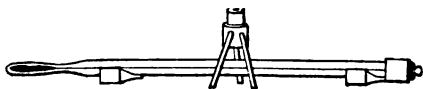

FIG. 30.

the division to be read appears straight (Fig. 24, p. 32), or a wire may be fastened to one foot so as to cut the optical axis of the lens. This wire

should then be seen below the thermometer as the prolongation of the line observed. The tenths of a division are estimated.

The readings enumerated only give five values, which differ from the intended length of 20° by c_1, c_2, c_3, c_4, c_5 . If we sum these deviations and divide by 5, then $c = \frac{c_1 + c_2 + \dots + c_5}{5}$ is the amount by which the thread has been taken too long (or too short, if c is negative). Consequently, if we subtract c from the separate readings, we have the lengths which a thread exactly a fifth of the interval between 0° and 100° would have covered. Taking

l_1	from 0 to	20	equal to	$20 + c_1 - c$
l_2	,, 20 ,,	40	,,	$20 + c_2 - c$
l_3	,, 40 ,,	60	,,	$20 + c_3 - c$
l_4	,, 60 ,,	80	,,	$20 + c_4 - c$
l_5	,, 80 ,,	100	,,	$20 + c_5 - c$

and adding, $l_1 + l_2 + l_3 + l_4 + l_5$ is necessarily equal to 100, and the sums $l_1, l_1 + l_2, l_1 + l_2 + l_3, l_1 + l_2 + l_3 + l_4$ represent the points at which the exact fifth-parts of the tube lie.

Besides these measurements, which should be twice or thrice repeated, the lengths

5-25, 10-30, 25-45, 30-50, 50-70, 55-75, 70-90, 75-95

are measured. The use of these will be seen later.

Next a thread 25° long is obtained as before, with which the measurements 0-25, 25-50, 50-75, 75-100 are performed. Let the

deviations of the measured distances from 25° be d_1, d_2, d_3, d_4 ; then we have again $d = \frac{d_1 + d_2 + d_3 + d_4}{4}$ for the amount by which each read-off length must be diminished to give the exact length of the quarter-scale. As before, the quantities $l_1, 0$ to 25 , equal to $25 + d_1 - d$, $l_2 = 25 + d_2 - d$, etc., give $l_1, l_1 + l_2, l_1 + l_2 + l_3$ the true places for the points $25, 50, 75$.

With the 25° thread the distances

10-35, 15-40, 20-45, 35-60, 40-65, 55-80, 60-85, 65-90

are also measured.

By the double division of the total length into 5 and 4 equal parts the corrections for the following points are now determined:— 20, 25, 40, 50, 60, 75, 80. In order to obtain the corrections for the other points, the extra measurements mentioned above are introduced, each being previously brought to the proper length by subtraction of c or d . From the 20° thread we get

$$\begin{aligned} 5 &= 25 - 20 \\ 30 &= 50 - 20 \\ 45 &= 25 + 20 \\ 55 &= 75 - 20 \\ 70 &= 50 + 20 \\ 95 &= 75 + 20 \end{aligned}$$

the true position being obtained by the addition or subtraction of the reduced length of the thread to or from the true positions 25, 50, 75. In the same way we get from the 25° thread

$$\begin{aligned} 15 &= 40 - 25 \\ 35 &= 60 - 25 \\ 45 &= 20 + 25 \\ 55 &= 80 - 25 \\ 65 &= 40 + 25 \\ 85 &= 60 + 25 \end{aligned}$$

All the points are now found except 10 and 90. The mean of the double determinations of 45 and 55 is taken. For 10 we have the two positions $30 - 20$ and $35 - 25$; for 90, the two $65 + 25$ and $70 + 20$. In each case the mean is again taken.

In this way we obtain the true positions of the consecutive twentieths of the total stem contents from 0° to 100° . If the corresponding numbers are subtracted from the nominal values the corrections for each place remain. These are represented graphically, and connected by a continuous curve, so that the corrections for intermediate values may be ascertained.

The calculation has, for the sake of clearness, been made on the

supposition that the boiling point and freezing point were correct. In general this is not the case, so that we must apply the method of reduction given on p. 11 by first adding the correction for the freezing point f to each place, and then distributing the difference between the corrections for the freezing point and boiling point b proportionally throughout the whole length, the amount $n \frac{b-f}{100}$ being thus added to the correction for the n^{th} degree. As both b and f are variable it is expedient to perform the calculation as here given, the bore alone being first corrected, and the error of the freezing and boiling points being afterwards eliminated.

A thermometer corrected in this way by no means coincides with an air thermometer, but shows deviations whose amount depends on the nature of the glass, and which are caused by both glass and mercury not expanding in strict proportion to the temperature as registered by the air thermometer. Here we must make a direct comparison of a number of points with the air thermometer, or with a standard thermometer already corrected by means of it.

The calibration has to be performed especially in the case of thermometers with a small number of degrees, such as are used for calorimetric work or the determination of molecular weights in solution.

If the thermometer is short, or the bore nearly uniform, it is sufficient to determine 4 to 6 points by the help of a thread $\frac{1}{4}$ or $\frac{1}{8}$ of the total length (p. 47). For more exact methods of calibration see Guillaume, *Traité pratique de la thermométrie de précision*, Paris, 1889.

The comparison of two thermometers is best executed in a suitable thermostat (see next chapter), care being taken to avoid stiction by having a rising temperature and frequent agitation.

For temperatures above 100° the mercury thermometer becomes more and more uncertain as the temperature rises, the errors of the thermal after effect and the projecting mercury column (p. 46) being always more apparent. Great advances, however, have been recently made in this direction by the employment of specially prepared glasses.

To read the mercury thermometer above 360° , at which temperature mercury boils, the stem is filled with nitrogen or carbonic acid under pressure, and in this way it becomes possible with Jena thermometer glass to reach 550° . Above this temperature the glass begins to soften.

Besides the mercury thermometer there are other apparatus for measuring temperature in use, especially electrical instruments. These will be noticed in Chapter XV. For the determination of high temperatures see C. Barus, *Die physikalische Behandlung und die Messung hoher Temperaturen*, Leipzig, 1892.

CHAPTER V

THERMOSTATS

Melting-Points.—As most processes of physical chemistry are greatly influenced by the temperature, the production of a constant temperature is a frequently recurring task when accurate measurements are to be made. There are two principles applicable here—either more heat is supplied than is necessary for unavoidable loss, and the excess removed at constant temperature, or an automatic regulator is used, which exactly covers the loss. Of course this statement only applies when the temperature to be maintained is above that of the atmosphere; the rule for the converse case is self-evident.

In practice the first method is realised by taking advantage of changes in the state of aggregation. The maintenance of the temperature of melting ice is the best of such processes, from the great certainty with which this temperature can be produced and kept.

In places where pure snow cannot be obtained, as in all large cities, pounded ice is best for the purpose. To pound the ice a mortar should be used, 30 cm. or more in diameter and depth, turned from a piece of hard wood, a heavy pestle and a zinc cover with a hole in the middle being also provided. The pounding can be done very rapidly in such a mortar, the cover preventing the splinters from flying about. Special precautions should be taken that the salt used for freezing mixtures never gets into the mortar; the stock of it should be kept in another room.

To maintain the temperature at 0° with certainty it is necessary to embed the objects entirely in the pounded ice, and not to let too much water collect. Water in which pieces of ice are floating has never the temperature 0° even when constantly stirred, but always a higher one, depending on the size of the vessel and the vigour of the stirring.

If the freezing point must be got to within less than a hundredth of a degree, common ice is not always pure enough. It should then

be used to keep a vessel filled with partially frozen distilled water at the real zero.

No other liquids have come into general use for maintaining the constant temperature of their freezing points. The reason is that substances other than water are difficult to obtain pure in large quantities, and still more difficult to keep pure when in use. As an example of the occasional use of other liquids, De Visser's acetic acid calorimeter may be mentioned.¹

Boiling Points.—The second mode of change in the state of aggregation, ebullition, is much more generally useful. We have here a whole series of liquids which can be applied to maintain a constant temperature by boiling. The typical apparatus for this purpose is shown in Fig. 31. It consists of two vessels, one inside the other, of

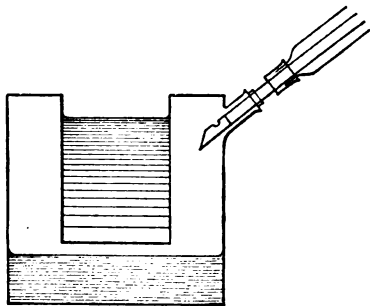

FIG. 31.

convenient size and shape (mostly cylindrical). In the space between the two there is the liquid, which is kept boiling, the vapour being condensed and returned to the boiler. According to the temperature desired, the apparatus may be made of soldered tin-plate, or brazed copper. Tin-plate is not suitable for water, as it soon rusts through. Iron covered with lead is better. The central space for holding the objects to be heated

contains water, glycerine, paraffin oil, or any other suitable liquid.

The condensed liquid is returned through an inverted siphon-shaped tube, as shown in Fig. 32. This somewhat complicated arrangement may, however, be dispensed with, if the condenser tube is wide enough, and placed in such a position that its whole section cannot be closed by the liquid. To prevent this it is advisable to bevel off the end. A hole (indicated in Fig. 31) near the lower end of the condenser is very effectual; even if the lower opening should be closed by the liquid, it allows a free passage to the vapour, and so entirely prevents the accumulation of liquid in the condenser tube.

The bottom of such vessels very soon shows signs of being attacked at the places which are in direct contact with the flame, the sulphuric acid from the sulphur compounds contained in the coal-gas being very destructive. These places, therefore, should be protected with asbestos paper stuck on by means of water-glass;

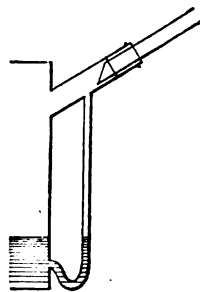

FIG. 32.

¹ *Zeitschrift für physikalische Chemie*, 9, 767, 1892.

although the conductivity at the protected place is much diminished, still if the bottom is broad there is little loss of heating power. A coating of magnesia stirred up in water-glass is also beneficial.

In the case of water being the heating liquid, the apparatus may often be simplified by omitting the inner bath, and subjecting the objects (flasks, cylinders, sealed tubes, etc.) to the direct action of the vapour. The apparatus then assumes the form of Fig. 33, the inner heating space, *A*, being surrounded by a steam jacket to protect it from external cooling; this is important on account of the heat capacity of the vapour being very small compared with that of the liquid. Such an apparatus can be made out of any tin can, if an arrangement, as figured in 33*a*, is placed inside. In this case it is

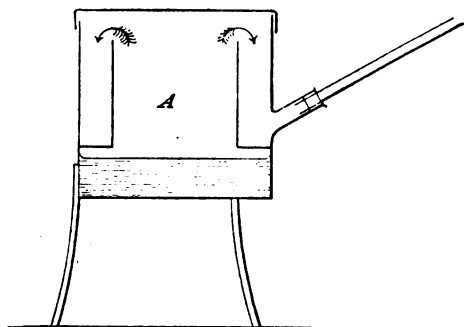
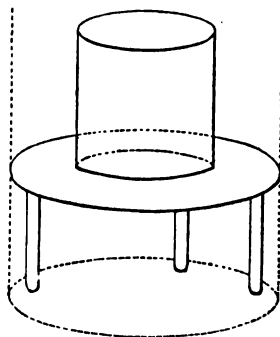

FIG. 33.

FIG. 33*a*.

simpler to dispense with complete condensation, and to supply the place of the vaporised water as it disappears by having a side tube, *a*, below the normal water-level connected with a Mariotte's bottle, *M*, by an india-rubber tube (Fig. 34). The downward bend on *a* is essential, as otherwise a circulation might be established between the hot water in the vessel and the cold water in the bottle. The tube *d* is carried so far upwards that no inconvenience is caused by the vapour emitted; thin-walled metal tubing 1.2 cm. diameter, and 1.2 m. long, gives pretty complete condensation with simple air-cooling.

The desired temperatures are produced by the selection of suitable liquids, the chief points to attend to being that the liquid is easily procurable, cheap, and unaltered by prolonged boiling. A general means of obtaining any temperature consists in varying the pressure under which the liquid boils. For this purpose the condenser is connected with a large vessel in which the desired pressure is maintained. As there are considerable difficulties in the way of making the apparatus perfectly air-tight, it is almost indispensable to add an automatic pressure regulator to restore and maintain the original

pressure, whereby the whole arrangement becomes somewhat complicated and only suited to permanent apparatus. As I have had no

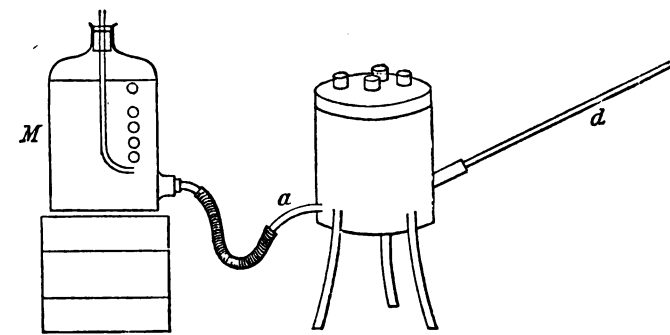

FIG. 34.

personal experience in this matter, I can only refer to the original sources.¹

Another means for changing boiling points within narrow limits lies in the addition of foreign substances. This method, it is true, scarcely yields so constant temperatures as in the case of pure liquids, on account of the difference in composition of the liquid and vapour, even when the condensation is very complete; but perfectly satisfactory results can be obtained when the difference is made as small as possible. This succeeds best with liquids which can be separated only with difficulty by distillation, especially with homologous compounds. Fair constancy of boiling point may thus be attained with mixtures of benzene and toluene, or toluene and commercial xylene, or with the hydrocarbons of petroleum.

All temperatures produced in this way are dependent on the state of the barometer, the deviation being on the average 0.03 degrees for a change of a millimetre of mercury.

Automatic Temperature Regulators.—The other principle for preserving constant temperatures—heat being supplied as demanded—is put into practice by means of temperature regulators. These all depend on changes of temperature setting a process in action which produces an increased supply of heat, and conversely. These regulators, like all others, suffer from the defect in principle that the process they are intended to prevent must first have occurred before they become active; in this way, therefore, we can only obtain an oscillation about a mean position, and not perfect constancy. This error, however, can be made very small by having the regulator

¹ Ramsay and Young, *Journ. Chem. Soc.*, 1885, 640; Pomplum, *Zeit. für Instrumentenkunde*, 10, 1, 1891.

sufficiently sensitive, so that it answers to very small disturbances; and in very many cases in practice a slightly oscillating temperature can be substituted for a constant temperature without any great risk of error being thereby incurred.

All temperature regulators are worked by the expansion experienced by substances on heating. By this expansion a movable part is set in action, whose change in position starts the regulating process. According to the nature of these two parts very different forms of regulators have been produced.

If a gas is the expansible body, a considerable sensitivity is obtained, but the action of the regulator depends on the barometric height. The same objection applies to the still more sensitive regulators based on the properties of saturated vapours, for the pressure at which a liquid is in equilibrium with its saturated vapour increases much more rapidly with the temperature than the pressure of gases.

Liquids have the disadvantage of possessing a smaller dilatation, and therefore give regulators of less sensibility than gases and vapours. On the other hand, they have the great advantage of their volume being independent of the state of the barometer, and should therefore especially be used when long-continued constancy of temperature is required. Liquids with great expansibility and small heat capacity are the most suitable, *e.g.* ether, alcohol, petroleum. Mercury is inconvenient on account of its great weight when we want sensitive regulators, which must contain a large volume of liquid; for less sensitive instruments its high boiling point and good conductivity tell in its favour. Water is an unsuitable liquid, especially at low temperatures, as its expansibility is small. Salt solutions are better, for they not only expand more at low temperatures, but also on the whole more uniformly.

Solids usually admit of the construction of more simple apparatus than gases or liquids, for in their case no containing vessel is needed. They are inconvenient, however, on account of their very small dilatation, great lengths being necessary to secure sufficient sensitivity. This disadvantage, however, may be lessened by transforming their motion into one of greater amplitude, which can be done very simply by using strips composed of two metals of different expansibility, the unequal expansion causing a considerable change of form by curvature.

The movable parts regulating the supply of heat receive their form according to the mode of heating. For our purpose coal-gas is to be first considered, its flow to the burner being regulated; and to begin with, we shall speak of mechanical regulators.

The Gas Regulator.—If the expanding substance is a gas, the vessel in which it is contained is placed in the space where the temperature is to be kept constant. This vessel is connected with

one limb of a U-tube, in the bend of which mercury is contained, the other limb carrying inlet and outlet tubes for the coal-gas (Fig. 35).



FIG. 35.

This part, which remains the same for regulators with a liquid instead of a gas, is of great importance, inasmuch as the delicacy of the regulator depends directly on its construction.

The width of the limb is determined by the supply of gas required; for most purposes 3 mm. is enough. One limb may be put inside, instead of alongside, the other, when we obtain the form shown in Fig. 36. This form is for some purposes more convenient, *e.g.* when a saturated vapour is used; while it has the slight advantage of being less easily broken, it has the drawback of a large dead space, and needs a large quantity of mercury.

A very important point is the shape of the end of the inlet tube, which must be movable in order to admit of slight adjustments. Hitherto the lower end of the inner tube has, strange to say, always been so constructed that the regulator was made very insensitive, and consequently of very little use, on account of the tube being cut off bevelled or provided with a side slit, so that a considerable motion of the mercury was necessary to make any significant alteration in the gas-supply. It is manifestly more rational to cut off the tube at right angles to the axis, so that it is shut by a very small rise of the mercury, and opened again by a correspondingly small fall.

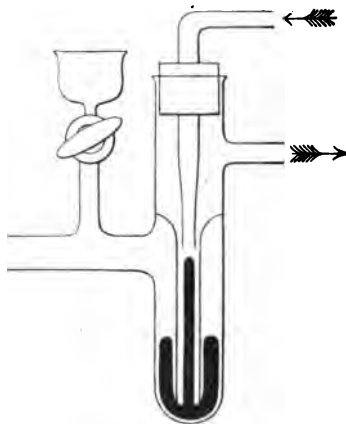

FIG. 36.

In order to guard against complete extinction of the flame, it is expedient to make a perforation in the side of the inlet tube nearly opposite the exit, just large enough to feed a small flame and maintain it while the end of the tube is closed. A somewhat more complex but easily regulated arrangement for the same purpose is obtained by having a branch tube leading directly to the burner and provided with a tap (or a screw clip if a rubber tube is used), by means of which the size of the permanent flame may be adjusted. This branch is shown in Fig. 37, *r* being the clip. If air is the regulating material the apparatus presents the appearance shown in Fig. 38. The air chamber is made as long as possible so as to lie

across the whole space to be regulated, and is connected by a capillary, preferably of lead, with the regulator *R*, which is placed in the neighbourhood of the burner, by means of which the space is heated.

The tap of the regulator is left open until the desired temperature is reached, on which it is closed, any small adjustments afterwards found necessary being made by moving the inlet tube a little up or down.

The connection of the three parts—air chamber, regulator, and burner—can of course be made in a great variety of ways, the most convenient for the purpose in hand being selected. The air space in the regulator below the tap should be made as small as possible, since it acts as a second air chamber exposed to varying temperatures, and therefore produces errors in proportion to its size. The same precaution should be taken with liquid regulators. Gas thermostats may be constructed of great sensibility on account of the large temperature coefficient and small heat capacity of the regulative substance; but it

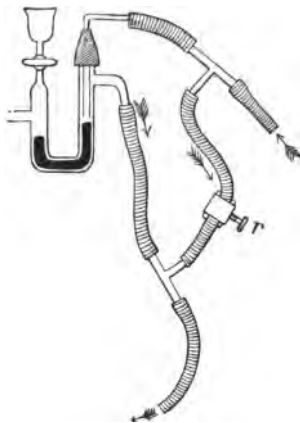

FIG. 37.

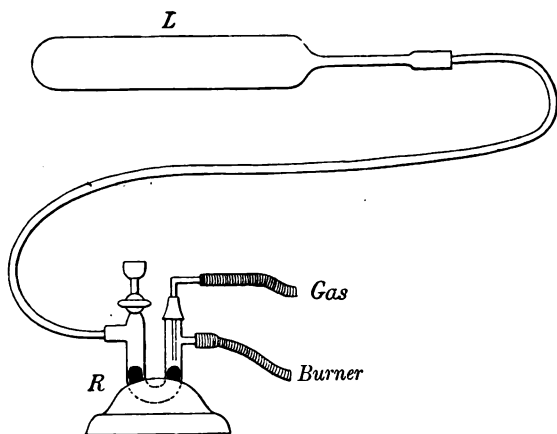

FIG. 38.

is useless to carry this to an extreme degree, seeing that changes in the height of the barometer occasion variations of temperature soon exceeding the other errors of the instrument.

Vapour Regulators.—Since the pressure of saturated vapours

depends only on the temperature and not on the volume, a definite change of temperature in a vapour thermostat will cause a definite change in the height of the mercury column independent of the other proportions of the apparatus. We may, therefore, make the vapour chamber as small as we please without loss of sensibility, nothing being gained by increase of dimensions. If excessive sensibility is desired, the cross-section of the mercury column may be increased so that a small movement of it may cause a great change in the flow of gas. In such a case attention must be paid to the accurate plane termination of the inlet tube and its accurate horizontal position. An exaggeration of the effect in this way, however, is seldom needed, as the regulator is very sensitive under ordinary conditions, and is also affected considerably by the state of the barometer.

The principle of these instruments has been given by Andreae,¹ according to whose observations they maintain the temperature constant to 0.04° - 0.05° . The liquid (Fig. 39), the boiling point of

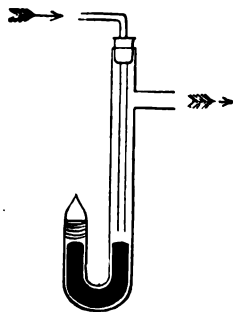

FIG. 39.

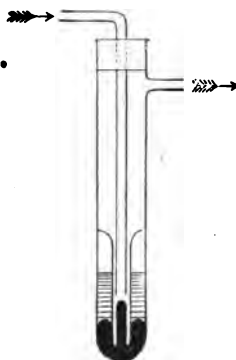

FIG. 40.

which must be at the desired temperature, is simply placed in the short limb, and the point is then sealed off. The great simplicity of the arrangement admits of a whole series of such instruments with different liquids being kept ready for use. More compact and more convenient instruments may be obtained when one limb is placed inside the other, as in Fig. 40.

The vapour regulator in these simple forms has the defect that the mercury is heated to the constant temperature. Up to 50° this does not matter much, but above that temperature the vaporisation of the mercury must be taken into account, all the more because the surface is exposed to a continuous current of coal-gas which communicates the mercury vapour through the burner to the air of the room. This defect does not exist in the case of air regulators, the

¹ *Wied. Ann.*, 4, 614, 1878.

mercury there being placed at any desired distance from the heated chamber. To avoid it in the case of vapour regulators, the form given in Fig. 41 may be adopted, in which the connecting tube between the vapour chamber and the regulator is made of thick-walled glass tubing about 1 mm. diameter, and completely filled with the liquid. The regulator may thus be removed from the heated space, with the gain of the above-mentioned advantage of the air thermostat.

Benoit¹ introduces between the vapour chamber and the regulator a long rubber tube filled with mercury, so that by changing the height of the column the temperature may be varied. This arrangement, however, can only be used for small variations. For low pressures the apparatus becomes less sensitive, for high pressures the sensibility increases.

Liquid Thermostats.—When a constant temperature has to be maintained for a long time, liquid thermostats are to be preferred to those with gases or vapours on account of their being independent of the barometer. To secure sufficient sensibility a somewhat large quantity of liquid must be taken, and this should be enclosed in a long tube, not in a spherical vessel, in order that the heat exchange may be as rapid as possible.

They are constructed quite similarly to gas thermostats, so that the forms described for these can also be adopted here. The form I have used myself for the last ten years is sketched in Fig. 42. On the bottom of the water-bath is placed the elongated chamber for the liquid, the neck of which rises up by the wall of the bath and is bent over horizontally at the top. Fig. 35, p. 56, shows the mode of connection of the neck with the regulator by means of a small piece of rubber tubing.

For filling the tube I have hitherto used a 10 per cent solution of calcium chloride, which at low temperatures expands much more, and much more regularly, than water. I have never used petroleum, alcohol, or ether, which would give more sensitive regulators, on account of their much larger coefficients of expansion, because loss is

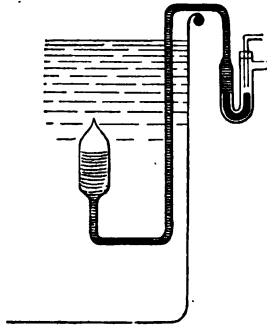

FIG. 41.

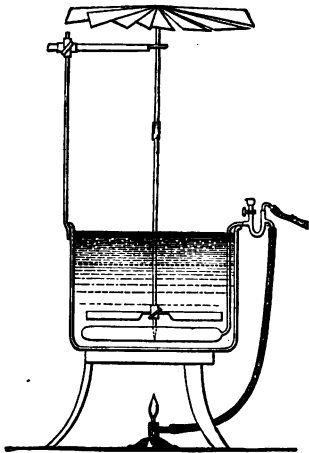

FIG. 42.

¹ *Jour. de phys.*, 8, 346, 1879.

to be feared from capillary movement or evaporation at the junction and at the tap, which is not the case with calcium chloride solution; for, in the first place, this solution is only slightly volatile; and secondly, separates out no solid salt on evaporation, which would almost unavoidably make the joints leak. For series of experiments which occupy only a short time—a few days—the above-mentioned highly expansible liquids may be used with advantage.

D'Arsonval has given an original form to liquid thermostats by using the regulating liquid simultaneously as heating bath, and thus obtaining great sensibility (Fig. 43). An annular space between two cylinders is completely filled with water which acts by its change of volume on the regulator *R* to be afterwards described.

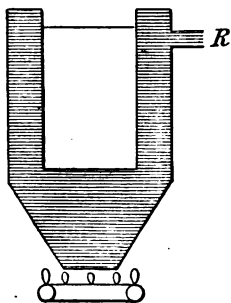

FIG. 43.

The arrangement is very sensitive, on account of the great quantity of expanding liquid and the circumstance that the flame acts on this directly without the intervention of a bath. The great sensibility is, however, partially illusory, owing to the unavoidable want of uniformity in the distribution of temperature throughout the large mass of water, which cannot be thoroughly mixed mechanically. In addition to this the apparatus is costly, as it

must be constructed of stout copper to prevent slight indentations of the walls spoiling the regulation, and is not easily adaptable to varying requirements—two circumstances which evidently prevent its coming into general use.

Instead of letting the increase of pressure or of volume act on a movable column of mercury, we may let it act on an india-rubber membrane—a suggestion also due to D'Arsonval. I formerly worked with many membranes of this sort, using an apparatus of the form given in Fig. 44. The chamber with the expansible liquid ends in a short side tube *S*, over the mouth of which a thin membrane of india-rubber (a piece of a small toy balloon) is tied, the tap for adjusting the temperature being fixed on above. The glass inlet and outlet tubes are made in one piece and fixed on the side tube by means of a cork. The end of the inlet tube opposite the membrane must be ground perfectly plane, the border at one place being slightly bent over in order to keep the flame in when the membrane touches the tube, which should be $\frac{1}{2}$ to $\frac{2}{3}$ the diameter of the membrane.

This regulator is very sensitive, but unless carefully treated goes wrong more easily than the arrangement with mercury. Only air, water, or salt solutions can be allowed to come in contact with the membrane, as most other liquids either dissolve or soften india-rubber. In the course of time evaporation from the water or salt solution

occurs through the membrane, thereby causing a change in the temperature. This source of error may be avoided by passing the coal-gas over (not through) water contained in a special bottle.

After using this regulator for several years I have again given it up, as the mercury regulator is easier to handle. I have described it here, however, since it can render good service in special circumstances and is independent of gravity.

Thermostats with Solids.

—Solids are mostly used for constructing thermostats of small sensibility for high temperatures, since their coefficient of expansion is small. A regulator of this sort has been described by von Babo¹ to

keep the temperature of a tubular furnace constant within a few degrees, but does not seem to have come into general use. A very simple form for the same purpose is shown in Fig. 45. The regulator consists of a glass tube 5 mm. in diameter, as long as the furnace, and provided at the wide end with a short side tube. A fairly large inlet tube, with the end ground off plane, is made adjustable in the widened portion. The regulating part

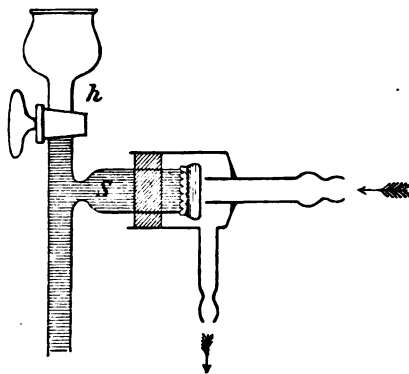

FIG. 44.

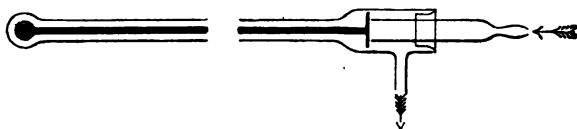

FIG. 45.

consists of a zinc wire fastened at the further end of the glass tube with plaster of Paris, and bearing at the near end a plane metal plate opposite the end of the inlet tube. Since zinc expands much more than glass, the plate approaches the opening of the inlet tube as the temperature rises, thus diminishing the flow of gas, and conversely. The apparatus is useful for rough regulation of $\pm 5^\circ$, and is easy to make and preserve in order.

In Lothar Meyer's apparatus² the expansion of a rod moves a lever which communicates the motion in exaggerated form to a modified mercury regulator. The arrangement is somewhat complicated and needs to be firmly fixed up. Like most of the older

¹ *Berichte*, 13, 1222, 1880.

Ibid., 17, 478, 1884.

instruments, too, it is made much less sensitive than it need be from the ill-chosen shape of the inlet (cf. p. 56). I have no practical experience with this apparatus.

Spirals made from a band of two metals of as different expansibilities as possible rolled together (usually steel and brass) should be quite suitable for the construction of thermostats. The flat form generally chosen is not so suitable as the screw form, for the change of curvature by the temperature is proportional to the curvature itself, from which it results immediately, that the band should be coiled in the form of a somewhat narrow (1-2 cm.) screw. Up till now such spirals have only been used for rough work, *e.g.* as security against the accidental extinction of gas-flames.

They might probably be made quite useful for finer work, especially if connected with electromagnetic and not mechanical regulators.

Electromagnetic Regulators.—Any of the regulators described above can of course be used to make and break an electric contact, by means of which an electromagnet is set in action to open or shut off the flow of gas. The simplest of such arrangements is a large open mercury thermometer, into which a platinum wire projects as far as the position occupied by the surface of the mercury at the desired

temperature. A second platinum wire is sealed into the bulb, and between the two the battery *B* and the electromagnet *E* (Fig. 46) are interposed, the latter regulating the gas-supply. The armature of the electromagnet may be made, for instance, when it is attracted, to turn a tap, to clip an india-rubber tube tight, etc.

The great drawback I find with such instruments is, that the current always remains closed for a considerable length of time. This causes a rapid running down of the battery, which in its turn easily occasions the regulator to fail in its action. If use is made of the principle of electromagnetic control, the apparatus must be so constructed that each increase or diminution of the size of the flame only necessitates a momentary current. This can be

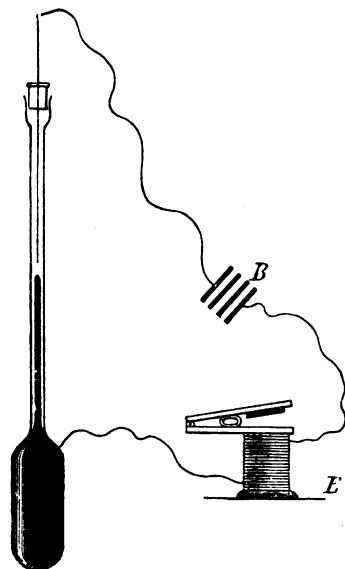

FIG. 46.

carried out in many ways by adopting the principle of automatic interruption. A scheme is given in Fig. 47. A battery *B* sends its

current to the movable contact C , which is acted upon in such a way by change of temperature that on cooling it moves towards 1, and on heating towards 2, the points 1 and 2 being as close together as we

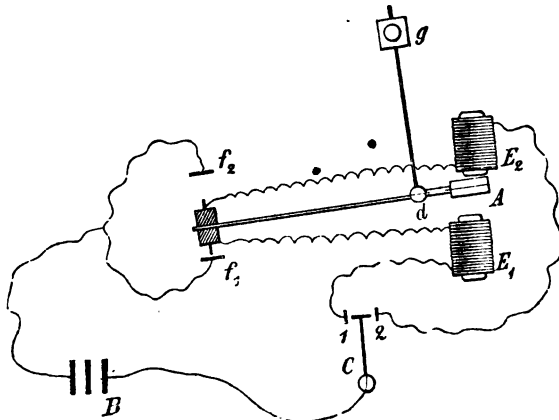

FIG. 47.

please. If it touches 1, the current goes through the electromagnet E_1 , and the armature A pivoted at d is attracted. The weight g is thus moved over to the right, the spring contact f_1 is opened, and the current interrupted. By means of this motion the flow of gas is increased by some sort of arrangement—turning of a tap, opening of a valve, etc. The resulting increase of temperature drives C towards 2; at the moment of contact the current is closed through E_2 and f_2 , the lever Adg swings over to the other side, diminishes the gas-supply, and opens the contact at f_2 until C again reaches 1, when the whole process is repeated. In order that the lever may remain in either position when the electromagnets are not in action, the weight g is so arranged that when the lever is in the middle it lies exactly above d and so makes both the right and left hand positions stable.

A brass-steel spiral (p. 62) would probably be found well adapted for making the contact at C ; or a U-tube filled with mercury might be used, communicating with an air chamber as before described (p. 57) and containing the contacts in the form of platinum wires. Since the distance between 1 and 2 may be chosen very small, the apparatus can be made extremely sensitive. I have not yet put it to a practical test, so that the above description can only be taken as a suggestion.

The Bath.—All the regulating arrangements described above are placed in the space which is to be maintained at a constant temperature. This space may be either an air bath or a liquid bath.

The former is altogether to be rejected for our purpose, since in an air-bath bodies assume the temperature of the surrounding air with extreme slowness. Water should be chosen as liquid wherever it can be used. For temperatures below zero, a salt, or better, alcohol, is added to the water in order to prevent freezing. Above 50° the evaporation of the water becomes troublesome; a thin layer of paraffin oil poured on the surface is very effective in diminishing this. If the water-level has to be kept unchanged, a sufficiently large Mariotte's bottle can be used to supply the loss by evaporation.

Above 90° we may use glycerine, paraffin oil, and similar liquids, according to circumstances.

The Stirring Gear.—Since neither the supply nor the loss of heat is uniformly distributed, there are always differences of temperature at different places in any thermostat, and these must be got rid of by mechanical mixing of the liquid, if equality and constancy of temperature are to be secured.

It is evident that rotatory stirring gear is to be preferred to such with reciprocating motion. The stirrer should then take the form of horizontal arms lying at the bottom of the bath and rotating round a vertical axis. The arms carry vanes set obliquely; and according to my experience they work better when the lower edge of the vane goes first, *i.e.* when the water is driven upwards, than the other way.

It depends on circumstances how the stirrer is set in motion. If a constant running motor is at our disposal, the connection is easily effected. It is even sometimes advisable to set up a special motor for one or several thermostats. Small hot-air motors (p. 65) can be obtained which are driven by a minute flame, and admit of enough work being taken off by a small disc and band to keep several stirrers going. If they are well taken care of they go day and night without stopping, and use very little gas.

All such arrangements, however, are surpassed in respect of simplicity and cheapness of construction by a windmill placed directly on the axis of the stirrer, and driven by the ascending current of air from a small gas-jet placed beneath it (Fig. 42, p. 59). It should be made of wire and stiff paper, aluminium foil, or mica, and should have a diameter of 40 to 50 cm. Such a mill can, of course, only perform a very small amount of work, and it is therefore important to get the axis as nearly vertical as possible, and avoid friction by having it rotating on a metal point in a small agate cup. With a little care it is easy to get it into working order and keep it going steadily.

Stirring by means of a current of air is a very simple method. Air is led in large bubbles through the liquid, the mixing being very effective. If a supply of compressed air cannot be obtained, a water blowpipe will be found convenient for producing the air current. It lies in the nature of the case that this process is less applicable at high than at low temperatures on account of the great evaporation.

Motors.—For thermostats, as well as for numerous other purposes, a mechanical arrangement is necessary for performing continuous rotatory or reciprocating movements, easy starting and steady working being in most cases the desiderata, rather than any considerable power of doing work. In the laboratory we may make use of gravitation, water, hot-air, and electromagnetic motors.

A very simple mechanical motor may be obtained by using the works of a stout clock, a crank or eccentric being attached to the prolonged axis of the balance wheel. To get the clockwork to go at the proper rate I have been accustomed to fasten to the crank a rod, by means of which a piston moves up and down in a cylinder. The piston does not fit quite tight, and the cylinder is filled with glycerine or a viscous oil. Since the crank makes the piston rod oscillate, the cylinder must be movable on an axis parallel to the crank axis. As the piston moves, the oil has to come alternately above and below it, and it is easy to ascertain the relations between the play of the piston, the stroke, and the viscosity of the liquid which will give the desired rate. The motion is not uniform, but jerky at the two dead points of the piston, which, for many purposes, *e.g.* in thermo-chemical work, is rather an advantage than otherwise.

For small power we may use the convenient form of turbine proposed by Raabe, which costs about ten or twelve shillings. The turbine consists of a paddle-wheel enclosed in a case and driven by a water-jet. A pulley is fixed to the axis on the outside, from which the work may be transmitted by means of an endless band. A very soft string should be used in order to lose as little work as possible, and some simple arrangement for tightening should be adopted.

The piston motors made by Schmidt of Zürich are much more powerful, but they can only be employed when the water pressure is considerable (over 5 atmospheres). They are therefore relatively seldom of use in the laboratory.

Of late I have employed for many purposes the small hot-air motors made by Henrici of Zwickau for about £2, which can be kept running continuously by means of a small gas-jet. They make three to five revolutions per second, and when set to go slower give enough work to drive small stirrers, etc. As gas (or a spirit-lamp) is in general more readily obtained than high-pressure water, these motors are susceptible of a very extensive application, their performance and durability being admirable.

Electromagnetic motors, finally, are very generally useful. If the laboratory is connected with an electric station, these motors are very easily set up and started. In many cases it is convenient to drive them from accumulators, greater independence of existing connections being obtained in this way. The use of ordinary galvanic elements as the source of power is, on the other hand, excessively inconvenient and expensive.

CHAPTER VI

GLASS-BLOWING

SOME practical acquaintance with glass-blowing is indispensable to the physical chemist, whose apparatus frequently assumes a suitable form only during the progress of his researches. The most important manipulations are therefore described shortly in this chapter.

The burner used almost universally is the coal-gas blowpipe. It should admit of the motion of the inner air tube and the outer gas tube with respect to each other in the direction of their common axis. If the openings of the tubes are close together, we obtain a pointed flame; if the outer tube is pushed forward (or the inner tube drawn back), a broader brush flame is obtained. These two forms of the flame are used according to the size of the piece to be heated. For the working of hard glass the temperature can be raised considerably by a block of charcoal behind the flame.

The air current is obtained by means of a foot-bellows or a water-blast. The former is usually placed beneath the blowpipe table.

Where no gas is to be had, a spirit-lamp with a broad wick may be used. Gasoline (volatile petroleum) also forms a suitable combustible.

The glass is used almost exclusively in the form of tubing, a suitable stock of which should be laid in. It must be kept lying flat, otherwise it becomes permanently curved.

All glass must be warmed gradually, the more slowly and carefully, the wider and thicker the tube is. The smoky flame is first applied and the glass removed from it for a moment from time to time in order to allow an equable distribution of temperature. Tubes warmed at the end crack much more readily than when they are heated at a distance from the end. While being heated, the tube must be turned incessantly and steadily on its axis; and this rule holds good in general for the manipulation of glass in the flame, when special circumstances do not call for exceptional treatment. When the article is finished, it is necessary, after taking it out of the flame, to blow into

it, so that at the moment of setting there should be excess of pressure inside. An article treated in this way cracks later or much less easily than one which has been left to receive its final form in the flame merely from the action of gravity and surface tension. To blow conveniently, a long piece of rubber tubing may be attached to the article and held by the other end in the mouth.

Cutting Tubes.—Tubes up to 8 mm. wide are divided by cutting them at the intended place with the glass-cutter, and then taking them in both hands so that the thumbs meet over the cut. A sharp, strong, bending motion will then make the tube break off evenly. An efficient glass-cutter may be made from a triangular file (a blunt one will do) by grinding off the teeth so that the corners form sharp straight edges. Such glass-cutters keep their edge very much better than those ordinarily obtainable, especially if the file is of good steel, and can easily be sharpened on the whetstone when they become blunt. The cutter should not be used with a sawing motion, as is customary with beginners, but should be pressed on the tube and rolled round it with a slight drawing motion, for its use is not to scratch the glass but to cut it.

Occasionally so short pieces have to be cut off tubes that they cannot conveniently be broken. In such a case we can proceed by making a cut at the proper place with the cutting file, melting a drop of glass at the end of a glass thread, and holding the drop, while still glowing, exactly on the cut; in a few moments the tube will crack off.

Wider and thicker walled tubes are divided by wrapping two rings of moist filter-paper round the tube 2 mm. apart, the cut lying between them (Fig. 48). The tube is rotated on its axis with the tip of the pointed flame playing on the exposed portion; in a very short time the cut extends suddenly through the whole section, and the tube divides perfectly evenly.

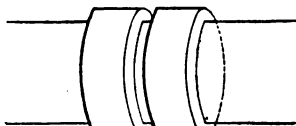

FIG. 48.

Thin-walled tubes are divided by means of a glowing piece of charcoal which prolongs the cut in any desired direction. The first extension of the cut usually takes place somewhat suddenly; the charcoal should be moved backwards and forwards over the cut in the proper direction, and the action may be hastened by touching the part heated by the charcoal for an instant with the moistened finger. If the tube is very wide it is well to mark the path to be taken by the charcoal with ink or chalk, otherwise the crack may run crooked. The rod of charcoal after use should be extinguished in sand or in a glass tube closed at one end and only a little wider than the rod itself.

The charcoal rod may also be used to restore an even mouth to a

flask with a chipped edge. A crack is led at least 5 mm. downwards along the neck, then turned at right angles and led round the neck. The crack will scarcely ever follow the charcoal for the last millimetre, and the pieces must be separated by hand.

The cut edges of tubes must always be rounded off in the flame if they are to form part of any apparatus; otherwise they are apt to cut both rubber tubes and the fingers.

Closing Tubes.—Narrow tubes are sealed by simply letting the end fall in when heated in the flame with constant turning. When wider tubes are to be closed they are not cut off, but drawn out. The drawn-out portion is again brought into the flame at *a* (Fig. 49), the tube turned steadily, the end again drawn off, and the whole end now heated in the brush flame, the tube being from time to time removed, and slightly blown out until the closed portion appears hemispherical and of the same thickness as the walls.

It is much more difficult to make a flat bottom. We proceed as above, but keep the bottom thin and heat it as far as *b*; it then of itself becomes flat. Special attention must be paid to turn the tube regularly, or else the bottom will slant to one side. The bottom of the tube is finally lightly pressed against a flat piece of charcoal and blown out gently. The end must be carefully cooled in the smoky flame, but even in spite of this the bottom often cracks, so that this sort of closing should only be used when special circumstances make it necessary.

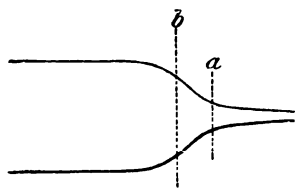

FIG. 49.

A supply of corks should be kept at hand to temporarily close tubes for blowing purposes, the narrow cylinders cut out by cork borers being very useful.

Drawing-out Tubes.—Tubes are heated at the desired place with constant turning until they are softened. They are then removed from the flame and drawn out. The walls are more or less thin according to the degree of softening and the rapidity of drawing out. Beginners usually make the mistake of not heating long enough to give the walls time to thicken sufficiently, so that the drawn-out portion is too thin-walled. If a jet has to be made, *e.g.* for a pipette, the tube is heated until a considerable thickening has taken place, and is then drawn out slowly quite a short distance, allowed to cool, and cut. If, on the other hand, the tube is to be closed, it should be drawn out smartly, so that no glass may collect which would afterwards have to be removed.

Blowing Bulbs.—A bulb is made on the end of a tube by closing it, warming a suitable length, and carefully blowing out. The blowing must be done outside of the flame with constant turning.

To produce a large bulb, a small thick-walled one is first made, which is then heated as uniformly as possible and blown to the requisite size.

The small tailed bulbs for vapour density determinations are made by first drawing out a narrow tube at two places, so that the glass required lies between them (Fig. 50). This part is then softened and blown, after which it is melted off at *a*. The tube is then drawn out at *b* to make another bulb, and so on.

If a bulb has to be blown in the middle of a tube, one end is closed, and the proper part thickened by heating, pressing together in the direction of the axis of the tube, and occasionally blowing out slightly. When enough glass for the bulb has been gathered, it is blown with constant rotation outside of the flame. It is well in this case also to do the blowing by degrees and not in one operation. Beginners will find it difficult to turn the softened tube with both hands so that the axis remains straight and the two parts do not get twisted as they are moved round.

Joining Tubes.—The beginner should practise joining tubes of the same diameter by closing one at the end, then making the two ends to be joined quite soft, pressing them together firmly outside of the flame, and drawing them out while blowing gently. With practice, tubes can thus be joined at one operation, but the beginner will usually find it necessary to heat the join again, and again draw it out while blowing. If the walls become too thin they must be thickened by pressing together gently and blowing. Continual turning is absolutely necessary.

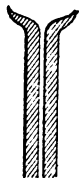

FIG. 50.

If tubes of different sizes are to be joined, the wider one is allowed to fall together until the opening is of the same size as the narrow tube. The ends are then heated, pressed together, and the joint blown and pulled out gently. This process is adopted when the wide tube is thin-walled and the narrow tube thicker, *e.g.* in pipettes. If the small tube is very narrow, it can be first widened by blowing a thick-walled bulb on it, and removing the outer portion by heating and blowing strongly, when an end, shaped as in Fig. 51, remains.

If the wide tube is very much wider, or very thick-walled, it is drawn out to the size of the small tube, care being taken that the walls of the drawn-out portion remain thick by letting them fall in. The tube is then cut at the drawn-out portion, and joined to the other tube as usual.

When capillaries have to be joined to other tubes, they must always be blown out to a bulb at the end, which is broken so as to give a regular border, as is shown in section in Fig. 52.

Occasionally complex pieces of apparatus, which cannot be freely

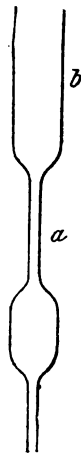

FIG. 51.

rotated, have to be joined together. In that case the freshly-cut ends of the tubes to be joined are placed against each other with slight pressure, and the pointed flame is moved slowly round the join as union takes place. The whole circumference is then warmed, and the fallen-in portion blown out, a very slight pull being given at the same time.



FIG. 52.

T-tubes.—Joints in the form of T-tubes are made by closing an end of each of the tubes to be joined, and warming the place of the cross-piece which is to receive the other tube in the pointed flame. When the spot softens it is at once blown out (best by means of a piece of india-rubber tubing attached to the open end), a hole being thus made in the wall. The size of the hole is adjusted to suit the tube which is to be joined on, and can be easily regulated by using a larger or smaller flame, and by blowing gently or strongly.

The pieces to be joined are then heated, pressed together for an instant, and pulled out somewhat with simultaneous blowing. If one has the knack, the joint is ready at once; the glass must be well heated, and the join made smartly and with confidence. The beginner as a rule makes lumps and folds, which are removed by directing the pointed flame on the defective places, softening them, blowing out, and letting them fall in again to the desired shape. This is continued until all the lumps and folds have been removed, the re-entering angles especially being softened and widened. In Fig. 53, *a* shows the correct, and *b* a faulty joint, which will inevitably crack sooner or later. All this must be done without letting the joint cool, for the glass is sure to crack on re-heating. Finally, the whole joint is warmed up and blown out gently.

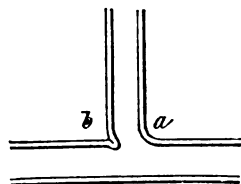

FIG. 53.

Bending Tubes.—Tubes up to 5 mm. diameter are best bent by bringing them lengthwise into a bat's-wing flame, and turning them until they bend by their own weight. If a very acute angle has to be made, the tube must be heated in the blowpipe, and bent and blown simultaneously. The same process is adopted with wider tubes. To bend a thin-walled wide tube properly is an art not easily acquired by beginners. A large flame is needed, and a long piece must be carefully and uniformly softened, bent, and blown out gently.

The Bunsen flame is of no use for bending tubes. Since the outer cone is much hotter than the inner, the tube softens more at two slightly distant spots than it does between them, and irregular forms result.

Turning-out Borders.—Wide tubes afterwards to be closed with stoppers, such as test-tubes, flask necks, and the like, are provided

with a turned-out border to increase their strength. The end of the tube is softened and continually rotated, the border being then made with a blunt conical piece of charcoal which is introduced into the softened mouth and turned round. Instead of the charcoal we may employ a tool constructed as follows:—A piece of brass foil, 4 to 5 cm. square, is folded so that its two diagonals form the four pyramidal edges shown in Fig. 54, the original sides forming a cross. The folded foil is set into the sawed-out, cross-shaped cuts in a wooden handle, and the tool is ready. It needs somewhat more skill to use it than to use the charcoal cone.

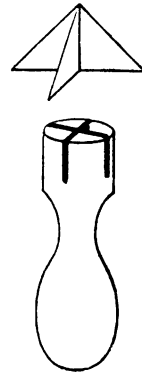

FIG. 54.

Sealing Platinum Wires.—In most cases the platinum wire is sealed into the end of a tube. The tube is drawn out, cut off short, and the end allowed to fall together in the flame until the platinum wire can just be pushed into the hole remaining (Fig. 55). The wire is then introduced and heated along with the glass until the latter closes round the platinum. When this is performed, the operation is finished by blowing in gently as usual.

It is important to get the glass and platinum to meet at as nearly as possible right angles, for then there is less chance of cracking. Cracks usually start from places such as *a* in Fig. 56.

A more certain result is obtained when fusible enamel is used. This is a tough lead glass¹ which unites well with ordinary glass

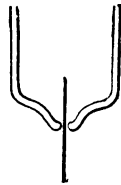

FIG. 55.

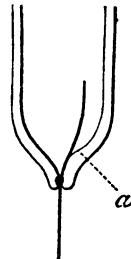

FIG. 56.

and also with platinum. In this case the hole is left 1-2 mm. wide, the platinum wire receives a drop of the melted enamel at the proper place, and is pushed through the hole until the opening is closed by the enamel, which is then fused to the glass, the joint being finally slightly blown out (Fig. 57).

It is somewhat more difficult to seal a platinum wire into the side

¹ Obtainable from F. O. R. Götze, Glass-blower, Leipzig.

wall of a tube. The spot where the seal is to be made is heated strongly and drawn out to a thick-walled capillary by applying a hot piece of thermometer tubing or a stout platinum wire. This capillary

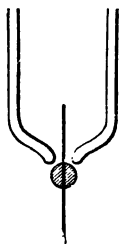

FIG. 57.

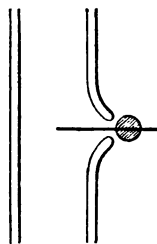

FIG. 58.

is then cut off pretty short, the further treatment being as described above. The final blowing out must not be forgotten.

Welding and Soldering Platinum.—Electrodes in voltameters and similar apparatus are made of platinum plates with platinum wires attached. To unite the two a polished piece of iron is laid on the blowpipe table as anvil, the wire is threaded through a few holes in the foil, so that it remains in the proper position, and the two are held about half a centimetre above the anvil and heated to white-heat in the blowpipe flame. A short smart blow is then given with a light, bright-faced hammer, that being sufficient to unite the foil and wire. Only one blow should be given, and not too heavily, else the wire is too much flattened and breaks off easily.

The place may be soldered with gold for safety's sake. A small scrap of pure gold (not standard gold containing copper) is placed at the joint, a trace of borax added, and the place heated from the other side. The heating is discontinued as soon as the solder is observed to melt.

CHAPTER VII

MEASUREMENT OF PRESSURE

Manometers.—Moderate pressures in gases or liquids are usually measured by the hydrostatic counter-pressure (hd) of a suitable liquid, so that the process is reduced to measuring the height h and the density d of the liquid. The determination of d is unnecessary when we use a liquid of known density, such as water or mercury. The apparatus used is called a manometer, and in general consists of a tube and a communicating vessel, which may be a parallel tube.

Liquids of low specific gravity are used for measuring small pressures. Water is not well adapted for manometric measurements, as it has a high surface tension easily altered by impurities. It should only be used when the measurements have not to be very accurate, and other circumstances are in its favour. Olive oil is a much more suitable liquid, as it has no measurable vapour pressure, and has a small and constant surface tension; the chief objection to its use is its great expansibility by heat, which must always be taken into account. In cases where the viscosity of olive oil is too great—for example, in narrow tubes—the more mobile petroleum may be employed.

The sensibility of manometers, so far as the measurement of length is concerned, may be increased by having the tube in an inclined position instead of upright. If a is the angle of inclination to the horizon, the pressure is then $p = hd \sin a$. These manometers, to give accurate readings, should be made of pretty narrow tubes, 1 to 2 mm. wide; for rapid movements petroleum may be used as liquid, if the pressure changes very slowly use may be made of oil.

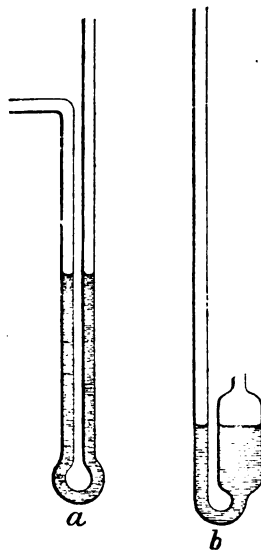

FIG. 59.

The commonest and theoretically simplest form of the manometer is a bent tube with the limbs as near to each other as possible (Fig. 59, *a*). Where only relative measurements are needed the reservoir manometer (Fig. 59, *b*) is often more convenient. This form, with one wide and one narrow limb, is usually adopted with inclined manometers.

Mercury as a liquid for the manometer possesses the great advantage of absorbing no gas in measurable quantity. As it is in round numbers fifteen times heavier than oil or petroleum, it serves for pressures up to several atmospheres. The surface tension is very considerable and is much changed by impurities, so that for accurate measurements the manometer tubes must be at least 6 or 7 mm. wide. The height of the meniscus is variable, so that for exact corrections it must be determined, as well as the diameter of the tube. I take the following table for this correction from Kohlrausch:—

CAPILLARY DEPRESSION OF MERCURY

Interpolated by F. Kohlrausch from Mendelejeff and Gutkowsky.

Height of Meniscus in mm.								
Diameter.	0.4	0.6	0.8	1.0	1.2	1.4	1.6	1.8
mm.	mm.	mm.	mm.	mm.	mm.	mm.	mm.	mm.
4	0.83	1.22	1.54	1.98	2.37
5	0.47	0.65	0.86	1.19	1.45	1.80
6	0.27	0.41	0.56	0.78	0.98	1.21	1.43	...
7	0.18	0.28	0.40	0.53	0.67	0.82	0.97	1.13
8	...	0.20	0.29	0.38	0.46	0.56	0.65	0.77
9	...	0.15	0.21	0.28	0.33	0.40	0.46	0.52
10	0.15	0.20	0.25	0.29	0.33	0.37
11	0.10	0.14	0.18	0.21	0.24	0.27
12	0.07	0.10	0.13	0.15	0.18	0.19
13	0.04	0.07	0.10	0.12	0.13	0.14

Reading the Height of Mercury.—The customary method of reading off differences in the height of mercury columns by means of a cathetometer is very unpractical, as the parallax error exerts an enormously great influence on account of the distance between the object and the scale. This error must be compensated by special care in the construction and manipulation of the instrument. Very much better is the method, introduced mainly by Bunsen, of providing the tubes containing the mercury with millimetre scales etched on them. In that case the reading telescope need only be approximately horizontal in order to make the parallax error practically vanish. A mixture of cinnabar, alcohol, and a little shellac varnish should be rubbed into the scale.

In many cases it is still more convenient to use the following method, which I adopted for measuring vapour pressures in a number of tubes standing together:—A millimetre scale is ruled on a sufficiently long strip of thick plate-glass, and hung vertically in front of the tube containing the mercury column, so that the scale faces and almost touches the tube. If there are several tubes together, the strip of glass may be taken broad enough, and the lines ruled long enough, to make all the readings on the same scale, but it is better to have a separate scale for each tube. If it is necessary to compare these scales, the pressure is adjusted so as to be the same in all the tubes (*e.g.* by opening them all at the top) and the corresponding readings are then made. Care must of course be taken that the scales do not afterwards alter their relative position, which is easily effected by fastening them all on one stand.

In some cases the height of a column of mercury above the level of mercury in a reservoir or mercury trough has to be ascertained. Troughs for this purpose are mostly provided with plate-glass walls, through which we read the scale on the tube—an inconvenient operation, as every one who has performed it must have experienced.

Gay-Lussac simplified the measurement by raising or lowering a double-pointed screw, of known length, in a nut fastened to the trough, until the lower point just touched the mercury in the trough. This can be very sharply determined by seeing the coincidence of the point with its mirror image in the mercury. Then by means of the cathetometer, for which this method was originated, the difference of level between the upper end of the screw and the mercury of the tube was ascertained, and added to the known length of the screw in order to obtain the total length of the column over the mercury surface in the trough.

I have made this process more convenient by replacing the screw by a float, so that no adjustment is necessary. A plate of any material which is without influence on mercury and suffers no alteration in the air, is cut to a suitable shape, *e.g.* like a horse-shoe, and made to carry a thin glass plate provided with a horizontal line 2 or 3 cm. from the bottom. The height of this line above the level of the mercury on which it floats is determined once for all. If the tube is divided, the float has only to be brought up to the scale, so that the horizontal line touches it, in order to make an accurate reading.

If the method with the glass scale is used, the divided strip may be furnished with a point in the prolongation of its middle line and directed downwards, and be so fastened as to permit a fine vertical motion, the operation being the same as with Gay-Lussac's screw. The distance between the point and the zero of the scale is determined on the dividing engine.

The method with the float can also be extended to this case by

providing the float with a glass scale. This arrangement, however, can scarcely be used with advantage for heights above 10 cm., as longer scales would necessitate large floats in order that stability might be preserved. I have not tried this method myself, and can therefore give no exact details.

If a scale is etched on the tube, then in very exact readings it must be borne in mind that in the immediate neighbourhood of the etched lines, an exaggerated section of which is shown in Fig. 60, there is a deflection of the light by refraction, which puts out the reading. In such cases the tube is placed in such a position that the lines only reach half across the field of vision, so that the ocular

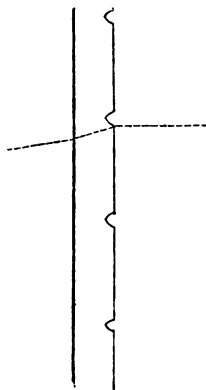

FIG. 60.

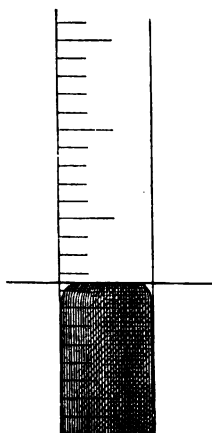

FIG. 61.

thread in the telescope may be adjusted to the unaffected portion of the field. The error may amount to several tenths of a millimetre. The same precaution must be taken when a glass scale suspended in front of the tube is used.

Vacuum Manometers.—A manometer open to the atmosphere is subject to the variation of the atmospheric pressure, which in certain circumstances may be prejudicial. Mercury manometers may be made independent of this by having a vacuous space above the column exerting the pressure, which necessitates them being made correspondingly longer. As the boiling out of such tubes with mercury is a somewhat difficult task, it may be obviated by providing the upper end with a tap through which the air-bubbles can be expelled. Below the tap there is a space of about 3 to 5 cc. shut off from the rest of the tube by means of a rather narrow capillary, into which a splinter of glass may be introduced if necessary. After the air has been driven through the open tap, this is shut, and as the mercury sinks, the thread is broken in the capillary, so as to leave

enough mercury in the upper space to close off the manometer from the tap (Fig. 62). If the tap leaks, the air that enters cannot penetrate into the manometer through the mercury in the upper part. Should the air pressure be so great that the mercury is forced down through the capillary, its disappearance from the safety chamber is a sign that the manometer must be freed from air again as before described.

The same device may of course also be applied to barometers.

A very convenient form of the mercury manometer is made by connecting the two limbs by means of a flexible rubber tube, which greatly extends the limits of its applicability. For most cases the tube should be very narrow, only a few millimetres in bore; if it is moderately thick-walled it then needs no external strengthening for pressures up to almost an atmosphere. If strengthening is necessary, a tube made of a linen band sewed together lengthwise can be used, or, in the case of wider tubes, a tubular woven lamp-wick. The rubber tube must be a black one free from sulphur, otherwise the mercury will be dirtied. If necessary the tube may be freed from sulphur by boiling out with caustic alkali. In making the apparatus care must be taken that the rubber tube is attached vertically to the glass tube, and not horizontally, for that drags and destroys the tube. The tube with its envelope is made fast with covered copper wire. It may be secured against external pressure by pushing a spirally wound wire inside. In narrow tubes two straight pieces of wire will suffice, but these also may of course be twisted round each other. Where mercury is used, the wire should be of softened iron; in other cases it should be of copper to avoid rusting. All this is rendered unnecessary by taking sufficiently thick-walled tubes.

Barometers.—Barometers are a special sort of vacuum manometer and serve to measure the pressure of the atmosphere. The various points just discussed apply equally to them both as to construction and reading. In the laboratory we generally use barometers carrying a millimetre scale on glass. Very frequently this is numbered from the middle, as zero, on both sides, so that the upper reading is made from below upwards, and the lower reading from above downwards; the height of the barometer is the sum of the two readings.

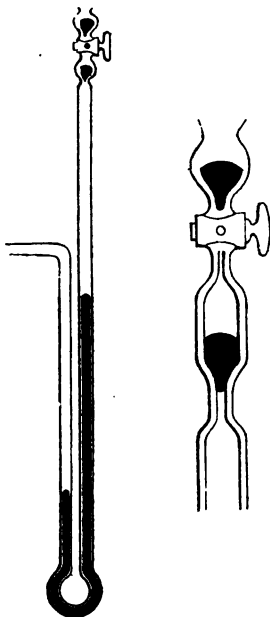

FIG. 62.

To avoid parallax, the barometer should be read with a small movable telescope, the tenths of a millimetre being estimated. The reading must be corrected for the temperature change in the specific gravity of the mercury, and in the length of the scale. For ordinary laboratory temperatures the coefficient of expansion of mercury is 0.0001813. If β is the coefficient of expansion of the scale, supposed to be accurate at 0°, then the height of the barometer reduced to 0° is

$$B_0 = B_t \{ 1 - (0.0001813 - \beta)t \};$$

where B_t is the height read at t° . For ordinary glass β is 0.000009 to 0.000010, for brass 0.00002, and for steel 0.00012.

In many cases the pressure to be measured appears as the difference of the external atmospheric pressure, measured by the barometer and the pressure of a mercury column closing off the space in which the pressure is to be determined. The errors of four readings then enter into the result, two for each of the mercury columns. This number may be reduced to half by bringing the barometer into the same mercury reservoir as the other tube. We then get a vacuum manometer as before (p. 76), and this has already been sufficiently discussed.

High Pressures.—Mercury manometers can only be used up to pressures of a few atmospheres with any degree of convenience, as above this the heights of the mercury columns to be measured are too great. For measuring high pressures we usually employ either the change of volume of a gas, or the change of form of a hollow solid.

Air manometers for high pressures have in general the form sketched in Fig. 63. The manometer consists of a divided thick-walled glass tube, to which is attached a wider glass vessel with an open bent-up end beneath. The lower part of the apparatus is fastened by means of a luted-in screw into an iron cylinder filled with mercury. A steel capillary connects this cylinder with the apparatus in which the pressure is to be measured.

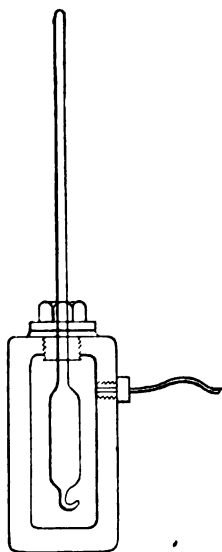

FIG. 63.

To prepare the manometer for work, the tube is first calibrated, next the volume ratio of the wide bulb to a scale-division of the tube is determined by means of weighing out with mercury, and the manometer is then filled with dry hydrogen. During all these operations the upper end of the tube remains open although drawn out to a fine point. It is then sealed off and the instrument

immersed at the same time in the mercury of the iron cylinder, atmospheric temperature and pressure being noted. After careful screwing up the manometer is ready for use.

The ratio between the volume of the bulb and of the tube must be chosen according to the range of pressure in which measurements are to be made. It is convenient to widen the tube somewhat at its upper end, so that at the highest pressures to be measured the mercury will just stop below the widened portion. In this way the manometer may be made much shorter.

Hydrogen, whose volume relations have been carefully investigated by Regnault, Amagat, and others, should be used to fill the apparatus. From the reading of the mercury in the apparatus we calculate the volume v to which the initial volume V of the hydrogen has been compressed. The ratio of these volumes would then give the pressure in terms of the pressure B which existed when the tube was sealed, if Boyle's Law were strictly accurate. Consequently,

$$p = \frac{VB}{v},$$

where p appears in the same unit (*e.g.* cm. of mercury) as

was used for measuring B .

On account of the deviation of gases from Boyle's Law, a correction must still be applied, which, in the case of hydrogen, takes a simple form. For this gas we have with close approximation $p(v - b) = BV$, where b is a constant practically independent of the temperature. If we reduce the initial volume V to the pressure 76 cm. of mercury (1 atmosphere), and call this volume V_0 , then we have for the calculation of the pressure p from the measured volume v the formula—

$$p = \frac{1}{\frac{v}{V_0} - 0.000662} \text{ atmospheres.}$$

It is assumed that the measurement takes place at the same temperature as the determination of V_0 .

The influence of temperature is somewhat complicated, so that it is best always to work at the temperature, *e.g.* 20°, for which the manometer was constructed. This is all the more easily done, as in order to obtain fairly accurate measurements, it is necessary to surround the manometer with a water jacket to keep its temperature constant. Such a jacket, in the form of a Liebig's condenser through which water of constant temperature flows, should also be used when the manometer is being made. In calculating the pressure conveyed through the capillary, attention must be paid to the fact that the mercury stands higher in the manometer than in the iron cylinder, and this hydrostatic pressure must be added.

Spring Manometers.—Much easier to use, but less accurate than gas manometers, are those which depend on the elastic deforma-

tion of solids. These are hollow rings or half rings constructed of an elastic metal—German silver for small pressures (Fig. 64, *a*), and steel for high pressures (Fig. 64, *b*). They should be filled with

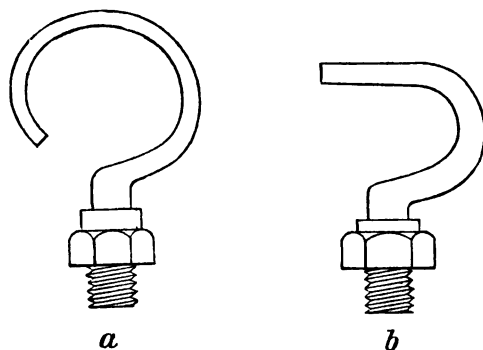

FIG. 64

paraffin oil to prevent corrosive gases from entering. If their interior is subjected to pressure, they stretch, and the free end moves so that the motion is approximately proportional to the pressure. This motion is usually communicated by toothed gear to a pointer, whose free play is got rid of by a small counteracting spring. They are convenient to read, but rather rough, and may be made better by using a long pointer, whose position with regard to a fixed scale is read off with any desired degree of accuracy by means of a lens or microscope. Or again, a small scale may be fixed to the pointer, and its position read off with regard to the cross wires of a microscope; if a micrometer is contained in the eye-piece instead of cross wires, the degree of accuracy can be still further heightened.

Still more sensitive, but less convenient on account of the necessity of very solid construction, is the reading with telescope and scale, a mirror being fastened to the free end of the manometer, the change of length in which is read off by observing the mirror image of a distant scale by means of the telescope. To control the mutual position of mirror and scale, a fixed mirror should also be attached to the body of the instrument.

It is not in general advisable to push the accuracy of reading the spring manometer too far. On account of elastic after-effect, the spring, after it has been subjected to pressure, does not return quite to its original position when the pressure is removed. An uncertainty is thus introduced into the readings which renders any greater apparent accuracy illusory. The relation between the reading and the pressure must be experimentally determined for each spring manometer. For this purpose hydrostatic or gas manometers are used, and a sufficient number of points are determined to admit of graphic or arithmetical

interpolation for the values between them. At the same time the amount of elastic after-effect is ascertained by doing one set of experiments with increasing, and another with diminishing pressure.

Piston Manometers.—Very useful manometers for high pressures are made on the principle of the hydraulic press. These give the pressures in terms of weight, and consist of a carefully turned piston which fits exactly into a cylinder supported on a tripod with levelling screws. The piston carries a round plate at its upper end on which weights are laid. The cylinder is filled with a thick oil (liquid paraffin or heavy mineral oil), the piston with its plate is then put in position, and weights to the proper amount laid on. The load must be carefully centred so that its centre of gravity is in the vertical axis of the piston; for facilitating this, the plate should be provided with a series of concentric circles. The right position of the load can be judged by seeing if the piston rotates freely on its axis without jamming. The pressure is then conveyed by means of the copper or steel capillary *k*; at the moment when the pressure corresponds to that exerted by the weight, the piston rises and usually makes a small rotatory movement.

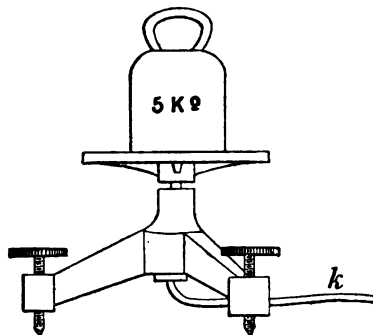

FIG. 65.

The pressure in atmospheres is given by the formula—

$$p = \frac{w}{1033q},$$

where *w* is the weight (piston, plate, and load) in grams, *q* the cross-section $\frac{1}{4}\pi d^2$ (*d*=diameter of piston), and 1033 the weight in grams equal to the pressure of one atmosphere per square centimetre. The variation of this magnitude with the gravitation constant has scarcely ever to be considered.

CHAPTER VIII

VOLUME AND DENSITY

DETERMINATIONS of volume are made for many purposes. In some cases they are employed directly, *e.g.* in the preparation and use of solutions for titration; in others the knowledge of the volume is used for the deduction of other magnitudes, amongst which the specific volume and the specific gravity or density stand pre-eminent. Since of all properties of matter the weight is relatively the least variable, the amount of other properties, so far as they are proportional to the quantity of matter, is best defined with respect to the unit of weight, or what is here practically the same thing, to the unit of mass.

The cubic centimetre, cc., is used as the theoretical unit of volume, and is the volume of a cube of 1 cm. edge. When the metric system was being evolved, it was intended to make the unit of mass equal to the mass of 1 cubic centimetre of water at 4°, and the original standard kilogram in Paris was constructed in accordance with this intention. Afterwards, however, it was found that the comparison of kilogram weights could be made much more accurate than the determination of the weight of 1 cubic centimetre of water at the maximum density point, and so it was resolved to take the original kilogram as the standard of weight, and to give up the definition with respect to the unit of length. However, this definition is fulfilled with such a degree of accuracy that for most purposes it may be retained and the cubic centimetre looked upon as the volume of 1 gram of water at 4° C. The error in all probability does not exceed 0·0001 of the total value, and therefore need not be considered in the vast majority of measurements.

For scientific determinations of volume, therefore, we use almost exclusively the volume of 1 g. of water at 4° as unit, and in the sequel we shall always understand the cubic centimetre to be this volume.

Measurement of Volume.—Determinations of volume when any degree of accuracy is required are always reduced to determinations of weight by filling the volume to be measured with a suitable liquid

and finding its weight. Water and mercury are used as liquids to the practical exclusion of all others.

Each has its advantages and its drawbacks. Water is easily obtained pure, and it is not very troublesome to fill a vessel completely with water, as the wetting of the walls helps this. Mercury is more difficult to purify and does not wet most substances. If the volume to be measured has acute angles and edges, the large surface tension of the mercury greatly hinders it from completely filling the space. On the other hand, the fact that mercury does not wet the walls gives us the possibility of measuring off and transferring definite volumes, whereby many estimations of volume are simplified. Lastly, mercury is indispensable for measuring small volumes by weighing, since it is 13.6 times heavier than water, and thus reduces the error of weighing in a corresponding degree.

In such determinations it is usually impossible to work at 4° and in a vacuum, so that measurements are made under ordinary conditions and afterwards reduced to standard conditions.

The following table recalculated from Scheel's data¹ gives the needful information concerning the volume of water at different temperatures. The temperatures are those defined by the hydrogen thermometer:—

VOLUME OF WATER

From 0° to 31°

0°	1.000126	16°	1.001025
1	1.000070	17	1.001193
2	1.000030	18	1.001373
3	1.000007	19	1.001564
4	1.000000	20	1.001768
5	1.000008	21	1.001981
6	1.000031	22	1.002204
7	1.000069	23	1.002438
8	1.000122	24	1.002681
9	1.000188	25	1.002935
10	1.000269	26	1.003199
11	1.000363	27	1.003472
12	1.000470	28	1.003788
13	1.000590	29	1.004045
14	1.000722	30	1.004346
15	1.000867	31	1.004656

If the volume in the foregoing table is denoted by ϕ_t , the space which contains G grams of water at the temperature t , contains $\phi_t G$ units of volume. The weight must be reduced to a vacuum as indicated on p. 39.

¹ *Wied. Ann.*, 47, 400, 1892.

Mohr proposed as unit of volume that of 1 g. of water at 17.5° weighed in the air with brass weights, and this unit is still used in constructing apparatus for volumetric analysis. As an apparent gram of water weighed under these circumstances is 1.00106 g., and the volume is greater by 0.00128 than at 4°, Mohr's unit is 1.00234 times the true unit, *i.e.* a Mohr's litre is 2.3 cc. too large.

If mercury is employed, it is of importance that the pure metal should be used in order that the volume may be accurately calculated from the weight. The ratio between the weights of equal volumes of mercury and water is equal to 13.5953 at 0°, *i.e.* 1 gram of mercury occupies the space of $\frac{1.000126}{13.5953} = 0.073564$ cc. at 0°. The mean coefficient of expansion of mercury between 0° and the atmospheric temperature is 0.0001813. If H , therefore, is the weight of mercury, reduced to vacuum, which fills the volume V at t° , this volume is

$$V = 0.073564(1 + 0.0001813t)H.$$

Purification of Mercury.—To purify mercury the metal is shaken up vigorously with dilute sulphuric acid, a few drops of potassium bichromate solution being added from time to time. The metal is then washed with a powerful jet of water, roughly dried with blotting-paper, and made to trickle in a fine stream through a column of 6-10 per cent nitric acid 60-100 ccm. long (Fig. 66). T is a funnel drawn out to a fine point, from which the mercury flows into the tube R . A thick-walled tube is sealed on to the bottom of this and bent as is shown in the figure. The mercury collects in the lower portion, the drops coalesce, and the metal flows dry through a at the same rate as it collects from above. The height of a is determined so that the mercury column in the wide part of the tube stands at least 5 cm. high when the whole tube is filled with acid. The tube is tied to the upright rod of a stand, the foot of which is provided with a raised edge to catch any mercury that may run over.

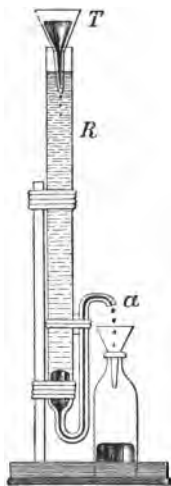

FIG. 66.

Apparatus for measuring Volumes.—Pipettes are used for measuring off quantities of liquid up to 100 cc. Only those with a jet at least 5 cm. long should be used (Fig. 67a); the form with a short beak (Fig. 67b) should in all cases be rejected on account of the indeterminate error caused by the drops of liquid adhering externally to the lower part of the body of the pipette. The upper end should be allowed to fall together in the flame until the opening is only 1-2 mm. wide.

Pipettes are almost always used for delivery, *i.e.* they are so

graduated that the determined volume of liquid flows out when they are filled up to the mark and allowed to run out. This volume depends on the quantity of liquid left behind on the walls, and the following precautions must be taken to secure accurate measurement. If a pipette has a very wide jet so that its contents flow out rapidly, the amount of liquid left behind is considerable and liable to variation. If the speed of outflow is diminished, the quantity of liquid remaining also decreases, and under a certain speed the wetting reaches a minimum which varies very little. This minimum is reached with certainty when the time of free outflow is forty seconds or more. Since the lower openings of pipettes, as supplied, are usually too wide, they should be allowed to fall together in the flame until the above time of outflow is reached, the walls at the point being simultaneously strengthened.

Another point to be attended to is the mode of ending the outflow. If this is allowed to take place with the point held free, a drop remains hanging whose size depends on adventitious circumstances. The drop is smaller if we keep the point of the pipette in contact with the wall of the vessel during the outflow; and then the size of the drop depends on the surface tension of the liquid. The most exact results are obtained by letting the point rest against the wall until the outflow ceases, and then blowing into the pipette without removing the point. The delivery in this way is as complete as can be obtained in any reasonable time.

Pipettes are not as a rule graduated for this sort of manipulation. Before they are used, therefore, they must be tested by weighing out with water, the volume found being used in calculating instead of the nominal volume. If we wish to get the real volume to correspond to the nominal value, it is best to buy pipettes without a mark and put this on afterwards. First of all, the approximate position of the mark is determined, a strip of millimetre paper is gummed on to the neck

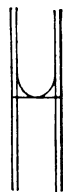
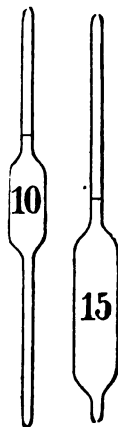

Fig. 68.

at this place and the contents are determined for two points 10 mm. distant from each other. On the justifiable assumption that the neck is cylindrical throughout this short piece, we can find the proper position of the mark from these two weighings. If, for instance, one weighing with a 10 cc. pipette is 10.032, and the other 9.908, then the mark lies

$$\frac{10.032 - 10.000}{10.032 - 9.908} \times 10 = 2.6 \text{ mm. below the upper mark or } 7.4$$

above the lower mark. The mark is adjusted so that it touches the meniscus from beneath (Fig. 68). A short mark is first made at the calculated place with a writing diamond, the paper



FIGS. 67a, 67b.

scale is removed, and the mark carried round by hand. As a guide, we may use a straight-edged piece of paper wrapped round the neck of the pipette just at the mark (Fig. 69).



FIG. 69.

Whilst for pipettes of 5 cc. and over, the forms usually sold can be used, the 1 cc. and 2 cc. pipettes are not suited for exact measurements. I have convinced myself that with pipettes of this size it is possible, with a little care, to measure quantities of water exact to 1-2 mg., if they have the form shown half-size in Fig. 70. The jet of the pipette is drawn out of the tube that forms the body; the neck, which may be 1-2 mm. wide, is sealed on. It is essential to have the jet narrow, slightly conical, and not too thin in the glass. The point is allowed to fall in a little by heating a very short time in the flame, whereby the durability is increased, and so regulated that the free outflow of the liquid lasts about a minute.

With these pipettes the blowing out while the point touches the wall is absolutely necessary if exact results are aimed at. To give an example, the following numbers were obtained for consecutive measurements with a 1 cc. pipette:—0.9995, 0.9990, 0.9998, 0.9997.

A great source of inconvenience in pipettes and other measuring vessels for delivery is their tendency to become greasy, which prevents uniform wetting of the walls. A certain means of bringing back such pipettes into working order is to leave them standing overnight filled with a solution of potassium permanganate. The precipitated peroxide is removed from the walls with an acidified solution of sodium sulphite or ferrous sulphate. A more convenient liquid, requiring no after-treatment, is strong sulphuric acid with a little potassium bichromate.

The distilled water employed is usually to blame for the greasiness of the pipettes, as it becomes contaminated with fatty matter when, as is generally the case, the distilling bulb and condensing tube are made tight with an oily packing. When a distilling apparatus is purchased or repaired, it should be seen that no fatty packing is used, otherwise traces of grease will appear in the distilled water for weeks.

Pipettes are best kept in upright cylinders, the bottoms of which are covered with filter-paper. The remnant of liquid in the pipette is then absorbed by the paper and the apparatus soon becomes dry. It should be made a rule to wash out a pipette with water immediately after use unless it is to be used at once for the same solution. In this way many "inexplicable" deviations in working will be avoided.

For measuring any quantities of liquid within given limits, divided cylindrical tubes with stopcocks are used. The readings of such

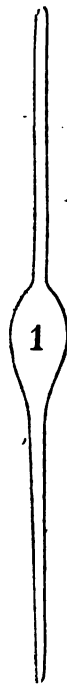

FIG. 70.

burettes are less exact than the readings of pipettes, on account of the greater cross-section.

Burettes are now to be had which are so carefully made that their error is only a few hundredths of a cubic centimetre. Nevertheless, it is necessary to test the accuracy of every burette used for scientific purposes, an operation which is easily and quickly effected by means of the following apparatus:—

A small calibration gauge, *ab* (Fig. 71), is fixed to the lower end of the burette, instead of the usual jet. This consists principally of a pipette holding 1 or 2 cc. (I use the last exclusively) between the marks *a* and *b*, and a side tube below the mark *a*. After all grease has been carefully got rid of, the burette and the other tubes are filled with water free from air-bubbles, and the level is adjusted to the zero division by means of the stopcock *I*. In the pipette the water is run out to the mark *a* by means of the clip *II*, and then water is run in through *I* from the burette until the level is exactly at *b*. The reading of the burette is then noted. The water is next run out through *II* until the level is again at *a*, then run in through *I* up to *b*, the second reading of the burette noted, and so on until the last division is reached. The readings of the burette give directly the positions at which the contents reckoned from the zero division are equal to 2, 4, 6, 8 . . . cc.,

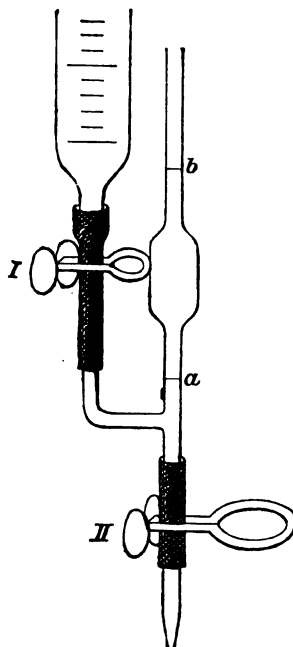

FIG. 71.

and the correction at these places is the difference between the nominal and the actual value. For instance, if 0, 1.98, 3.97, 5.99, 8.01, 10.04, etc., are the values actually read off, the corrections are respectively +0.02, +0.03, +0.01, -0.01, -0.04, etc. These corrections are written down on a narrow strip of stiff paper which is fixed up beside the burette when in use, so that each correction appears at its proper place. Every number read off is then corrected before being noted down. The intermediate values are got by simple interpolation.

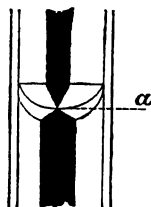

FIG. 72.

For the purposes of physical chemistry, we use almost exclusively burettes of 20 to 30 cc. capacity divided into tenths; the hundredths are estimated. The best readings are obtained with burettes furnished on the back with a black enamel strip on a white ground, as suggested by

Schellbach. When looked at by incident light they present the appearance of Fig. 72, the point *a*, to which the strip suddenly narrows, giving a very convenient and sharp reading which is only little affected by parallax. I have exclusively adopted these burettes for my own use.

Ordinary glass burettes are best read against a bright window, when the meniscus appears black on a light ground. Holding a black and white screen behind the burette cannot be recommended, as the position of the black meniscus depends greatly on that of the background. To avoid parallax entirely, a distant object in the line of sight should be selected, with which the meniscus should be brought into approximate conjunction while the reading is made.

In physico-chemical work we have almost always to make many measurements of the same sort, and it is thus possible to lighten the work considerably by choosing a properly arranged apparatus. A double-necked bottle (Fig. 73), in capacity 2 l. or more, carries a brass clamp on the middle neck, by means of which the burette is held vertical. Through the second neck there passes to the bottom of the bottle a tube connected by means of a rubber tube and clamp with the burette, which carries a side tube below the last scale-division. The burette is closed at the top by a perforated cork, through which a short glass tube passes, ending in a narrow rubber tube with a mouthpiece. The burette is filled to the zero mark by sucking through this rubber tube while the upper clip is open. The middle neck is connected with the open air by a rectangular capillary passing through the cork. The evaporation is so slight that it is not measurable after weeks and even months, but after every pause in the work of long duration, 5-10 cc. should be run out of the burette to get rid of the effect

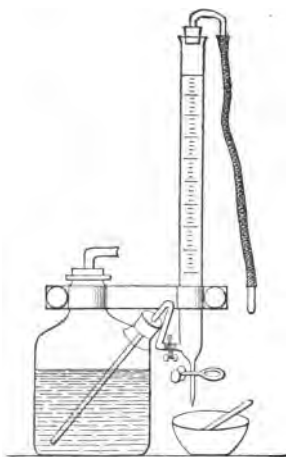

FIG. 73.

of any change of concentration which may have taken place at the jet. When not in use the burette should be filled up above the zero mark.

If we are dealing with liquids that must be protected from the carbonic acid in the air (*e.g.* potash, baryta water), both the middle neck and the burette are provided with a tube containing soda-lime between wads of cotton wool. The protecting tube in the case of the burette may be bent downwards (Fig. 74) to prevent the apparatus becoming inconveniently tall.

With solutions, such as iodine or permanganate, which cannot be

allowed to come in contact with india-rubber, a burette with a glass stopcock and a short side tube blown on above the zero mark must be used. The siphon tube is placed in the middle neck and discharges through a cork into the burette; the rubber tube for sucking up is attached to the side tube. In the case of iodine it is advisable to introduce a tube filled with coarse animal charcoal to protect the mouth from the vapours.

In some cases more liquid is required for one titration than the burette will hold. To avoid a second filling and reading, a burette may be used having the body of a pipette of the required capacity above the zero mark (Fig. 75). The second zero mark is at *b*. I have found it best to have the upper portion made to contain 20 cc. when the capacity of the burette proper is 25 cc. According as we have to work up to 20 cc. or up to 45 cc. the burette is filled up to *a* or *b*, and so we can almost double the range of titration without greatly adding to the length of the apparatus.

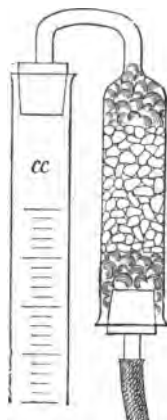

FIG. 74.

Divided Pipettes.—Divided pipettes are occasionally used, especially for rapid measurements of moderate accuracy. They are simply burettes with a narrow neck and drawn-out jet. The larger



FIG. 75.

forms, up to 25 cc., are scarcely practical, but measuring pipettes holding 1-2 cc. and divided into 0.01 or 0.02 cc. can often be used with advantage. If purchased, they have mostly to be drawn out again to a sufficiently long and narrow jet, as the jet is usually much too coarse for clean working. The very thick-walled tubing of which they are generally made is also responsible for considerable parallax errors. If such pipettes, then, are to be in frequent use, it is best to make them oneself from suitable tubing by weighing out and dividing.

Measuring Flasks and Cylinders.—Measuring flasks are mostly used in preparing solutions of definite volume, their contents being measured up to a circular mark on the neck. They must be checked by weighing out before use, but as a rule they are sufficiently exact. In scientific work measuring flasks should never be used for delivery. If a definite volume of a given liquid is to be measured and the flask is not dry, it should be rinsed out twice with the liquid. The same thing holds

good for pipettes.

Cylinders are used for the same purposes as measuring flasks. On account of the much less accurate reading due to the large surface, they should never be employed as real measuring instruments, but

only for rough estimations, in which an error of several per cent is not of importance.

Specific Gravity and Volume.—The ratio between volume and mass, which is called specific gravity (more strictly specific mass), or specific volume, according as the first is referred to unity of the second, or conversely, necessitates for its determination measurements of two magnitudes, the mass and the volume. The determination of the ratio may be made in three ways: we determine either the mass of a known volume, or the volume of a known mass, or else both the mass and volume of an arbitrary object. A further principle of subdivision in method is found in the state of aggregation of the object to be measured, the methods adopted being different according as the substance is solid, liquid, or gaseous. Measurements with liquids are the easiest and most exact.

Pyknometers.—If we ascertain the weight of a liquid which fills a space of known size, we can calculate from this the desired magnitude. The known space is generally the inside of a vessel which goes by the name of a pyknometer. An unpractical form of the pyknometer (Fig. 76) is in very general use. This is a small bottle with a ground-in and usually perforated stopper, its contents when the stopper is inserted forming the supposed constant volume in question. As the conical angle of the stopper must be small in order to get it to fit tight, a slight elastic deformation of the neck causes a considerable displacement of the stopper in the direction of its axis, which



FIG. 76.

creates a by no means negligible source of error not easily to be avoided. Kopp¹ first replaced the stopper by a mark on the constricted neck of the pyknometer (Fig. 78). The bottle is filled up as accurately as possible to the mark with the liquid to be investigated, the last adjustment being made by means of a capillary pipette (Fig. 79), which consists of a drawn-out glass tube with a rubber cap. When a cap is not to be had, a piece of rubber tubing closed by a short glass rod will do. The empty part of the pyknometer is carefully cleaned with filter-paper after filling.

If we have to deal with volatile liquids the instrument may be furnished with a ground stopper. In this case it is expedient to make the empty part of the bottle as small as possible.

To attain a more rapid equilibrium of temperature it is better to make the bottles cylindrical (Fig. 77) than spherical (Fig. 78) as usually happens; they are hung on the balance by a platinum or nickel wire hook.

The filling and emptying of bottle pyknometers is usually somewhat inconvenient, as the neck is made as narrow as possible in order to secure accuracy. The emptying may be easily effected by means

¹ *Pogg. Ann.*, 72, 1, 1847.

of a bent glass tube a little narrower than the neck of the pyknometer. If the pyknometer is slipped down over the short limb of the tube, the liquid can be driven out by blowing in air (Fig. 80). The liquid

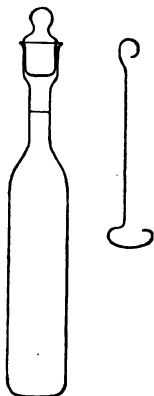

FIG. 77.

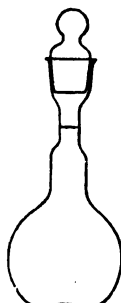

FIG. 78.

used for washing may be removed in the same way. In order to dry the instrument it is turned in the flame round the glass tube as axis, air being sucked through the tube at the same time. An empty

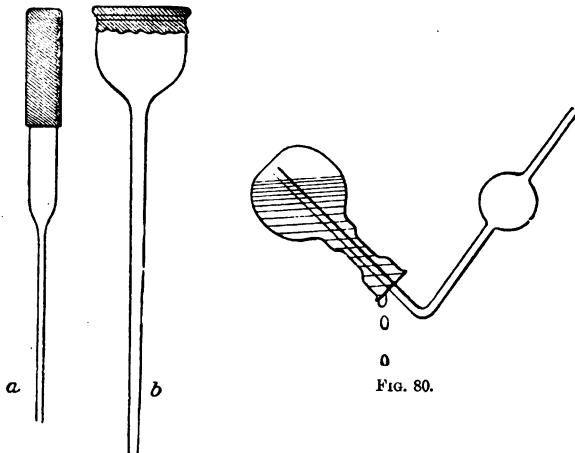

FIG. 79.

FIG. 80.

bottle should be connected with the tube by means of india-rubber tubing to prevent the hot vapours getting into the mouth, or the sucking may be done by an aspirator or Bunsen pump. The tube always becomes hot, and in order to handle it one or two corks

or pieces of rubber tubing should be slipped on to the longer limb.

The method with the specific gravity bottle, even in the form last described, is open to several objections which have been removed by the modifications of Sprengel and Mendelejeff. Sprengel's apparatus consists of a U-tube (Fig. 81) which ends on both sides in stout-walled tubes of 1 mm. bore bent over at right angles. One of them is drawn out at *b* to a stout narrow jet, the other is provided with a mark at *a*. The apparatus is filled by inverting it and dipping *a* into the liquid, while air is being sucked out at *b*. When it is half-filled, *i.e.* up to the bend, it is turned into the upright position and the filling completed.

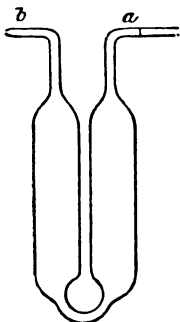

FIG. 81.

The constant volume of the apparatus is from the point *b* to the mark *a*. If the liquid reaches beyond *a*, *b* is touched with a little roll of filter-paper, which at once sets the meniscus in motion towards *a*. At the proper moment the filter-paper is taken away and the adjustment is complete.

Should too much liquid have been removed, *b* is brought into contact with a drop of it on the end of a glass rod, the liquid is drawn in, and the meniscus moves outwards. It is best to let too much liquid enter, and to make the adjustment by sucking out a little, so that the meniscus may always have the same form.

The Sprengel pyknometer is one of the most accurate of such apparatus. With an instrument holding 25 cc., determinations may be made with a probable error of about ± 0.00002 . In its original form, however, it has the drawback that in filling it has to be turned over at the right moment. The form suggested by me (Fig. 82), which permits filling in an unchanged inclined position throughout,¹ is therefore better. The requisite exhaustion can be conveniently made by means of a litre bottle furnished with a T-tube (Fig. 83), which is connected on one side with a long narrow rubber tube which may be slipped over *b*, and on the other with a short rubber tube and clip. One exhaustion of the bottle is sufficient to fill rapidly several pyknometers.

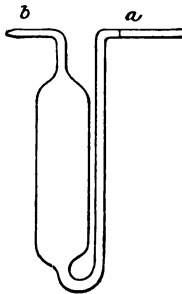

FIG. 82.

The apparatus is made larger or smaller according to the degree of accuracy desired; for very exact measurements I have gone up to 30 cc., and for moderate accuracy (± 0.0001) down to 5 cc. The error in weighing is of less influence in limiting the degree of accuracy than the temperature error; if the latter could be avoided, an accuracy

¹ *Journ. f. pract. Chem.*, 16, 396, 1877.

of ± 0.000002 or ± 0.000003 could be attained with pyknometers containing 200 g.

The pyknometers on Sprengel's plan have the great advantage over the bottles of being easily filled, emptied, and cleaned. For the last purpose the liquid is blown or sucked out through the wider limb α , the pyknometer washed out several times with water, and warmed by moving to and fro at a considerable distance above a flame, while a rapid current of air is sucked through. It is dried in this way in a few minutes.

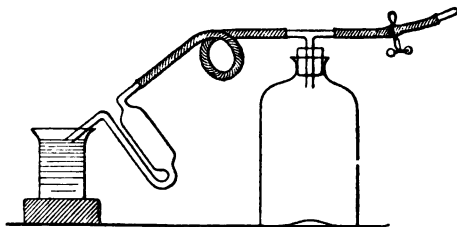

FIG. 88.

In very exact measurements attention must be paid to the fact that the glass after being dilated by heat does not immediately resume its original volume on cooling. As warming can scarcely be dispensed with in order to dry the apparatus quickly, it should therefore be done several hours before the instrument is used. Against this rule it may be rightly urged that the volume of a glass vessel remaining at the atmospheric temperature is the more constant the longer the glass is kept from great changes of temperature. It is thus in principle safer to avoid warming altogether.

The pyknometer may then be cleaned and dried by treatment successively with water, alcohol, and ether, the latter being very rapidly removed by a current of air. Great care is necessary in this, however, as ether which is not freshly distilled is only too apt to leave a considerable residue on evaporation.

Mendelejeff's pyknometer is similar to Sprengel's, with the difference that the two arms are at the upper end of a cylindrical vessel, a thermometer being so sealed-in that its bulb is in the interior of the pyknometer. To judge from the numbers given by its inventor, the instrument does not yield more accurate results than a Sprengel pyknometer of the same capacity. It has the further drawback of being much more expensive, and of the sealed-in thermometer being difficult to standardise and compare with a normal thermometer.

Weighing Glass Vessels.—Glass is a material which exhibits distinct differences in weight according to its treatment before weighing; for its surface is covered by a film of absorbed water having a very small vapour pressure, but capable of being driven off at a moderately high temperature. Different numbers are obtained according as this layer of water is weighed or not.

I find from my own experience that the most concordant numbers are obtained if the glass before being weighed is moistened and dried with a soft linen cloth; in this way we weigh it with the maximum

water layer. Only in cases where the treatment cannot be applied should we diverge from this rule. As the glass is mostly used as a vessel to contain another substance, whose weight is to be determined from the difference of weight of the full and empty glass vessel, the two weighings should be executed after the glass has had the same preliminary treatment in both cases.

Density Determinations with the Pipette.—Very rapid determinations accurate to 0.001 may be made with a 1 cc. pipette provided with tubes almost capillary. It is filled by sucking up to the mark and brought on to the pan of the balance by means of a bent wire support (Fig. 84). The capillary pressure completely prevents any flowing out if the point has been thoroughly dried. If the tare, equal to the weight of the empty pipette plus the support, has been once determined, the weight added when the pipette is full



FIG. 84.

gives at once the specific gravity sought.

The Hydrostatic Balance.—A constant liquid volume may also be weighed by immersing a solid in the liquid. The solid may be attached to the balance and its loss of weight in the liquid determined, or the liquid may be brought into equilibrium on the balance and its increase of weight ascertained when the solid is immersed in it. The last method is for various reasons the less practical and therefore the less convenient; it is, in fact, only adopted in exceptional cases.

The first process was formerly much in vogue, and is described with the greatest minuteness in most physical text-books. It is, nevertheless, neither more accurate nor more convenient than the method with Sprengel's pycnometer, and suffers especially from the disadvantage that it is difficult to maintain the temperature of the liquid uniform, as any currents during the operation of weighing would cause considerable and indeterminate errors. We need not therefore describe it here in detail.

In a special form, however, the method has been worked out by F. Mohr for approximate determinations to three significant figures. If the arm of the balance used is divided into ten equal parts, and the riders are so constructed that their weight is equal to the loss of weight of the immersed body (a very short thermometer, hanging by a platinum wire) in water, and to a tenth and to a hundredth of this respectively, the specific gravity is given directly by the reading. Westphal's form of Mohr's balance has only two axes, and is in equilibrium when the float hangs in the air.

For the balance to be in equilibrium in water, a weight must be hung on the hook from which the float is suspended, equal to the loss of weight of the float in the water. A second equal weight in the form of a rider may be moved on the beam of the balance until

equilibrium in a second liquid takes place. This only holds for liquids heavier than water; for lighter liquids the first weight is taken off altogether.

To determine the position of the rider more exactly, the beam is divided by notches into ten equal parts, and the rider is hung in the notch which lies nearest the true position on the side of the principal axis. The same process is then repeated with a rider of a tenth of the weight; and finally, the rider of a hundredth of the weight is adjusted on the beam. As a rule, shifting this rider from one notch to the next just makes an appreciable difference, so that its position can only be determined to a whole division. If we now write down the number of the notches in which the riders hang, as successive decimals, taking the large rider first, then the tenth, then the hundredth, and beginning with 1 or 0 for the whole number, according as the weight is on the hook or not, we obtain the required specific gravity of the liquid, as is easily seen from a consideration of the simple lever.

Reimann has made a very practical modification of Mohr's balance by introducing a scale pan between the beam and the float, and giving the latter a volume of 1 cc. or 10 cc. This is done by first making it somewhat too large, and then grinding down a solid glass piece fixed on for the purpose until the loss of weight in water is equal to 1 g. or 10 g. exactly. This arrangement has the advantage of allowing an ordinary set of weights to be used, the weight added giving the specific gravity directly, after the decimal point has been placed. The balance has two axes, and the beam is not divided.

Fahrenheit's Hydrometer.—The use of the beam balance may be dispensed with altogether by making the float rather lighter than the weight of liquid displaced, and providing it with a narrow neck carrying a small pan at the top. The centre of gravity must lie as low, and the metacentre as high, as possible. The body of the float is made of glass, and is loaded with mercury at the bottom. The sensibility of the apparatus depends on the neck being as narrow as possible, for the vertical motion due to a given added weight is, *cæteris paribus*, inversely proportional to the cross-section of the neck. This is the weak point of the method, as a narrow neck makes the apparatus fragile, and a stout neck makes it insensitive.

The only case in which this instrument has any advantage over a Sprengel pyknometer is when no access can be had to a good balance—a case which will scarcely ever occur.

Aræometers.—Only one form of instrument, the aræometer (or ordinary hydrometer), is used in the second group of methods for determining the specific gravity, which depend on the use of a constant weight with varying volume.

This instrument consists of a spindle-shaped float with a cylindrical neck containing a scale. The weight and volume are so adjusted

that the apparatus sinks to the lowest mark on the neck in the heaviest liquid to be investigated, and to the highest mark in the lightest liquid. As it always displaces its own weight of liquid, an equidistant division of the neck (the volume of displaced water being made unity) would give directly the volumes of equal weight, *i.e.* the specific volumes. As we are accustomed, however, to ascertain the specific gravity, the corresponding scale must be constructed, equal differences of specific gravity not being represented on it by equal distances.

In physico-chemical work the aræometer is only used when relatively rough determinations have to be made with liquids obtainable in quantity. For such purposes the instruments used for commercial purposes are in general sufficiently exact; and it is scarcely worth while testing them. For scientific purposes the methods described in pp. 90-93 are much to be preferred.

Specific Gravity Balls.—In intimate connection with the methods just discussed there is an excessively sensitive means, not exactly of determining the specific gravity of a liquid, but of determining a certain value of it, if it be variable, by dilution or the like.

If a body floats fully immersed in a liquid of approximately the same specific gravity, very small differences of density are sufficient to make it rise or sink. The body is usually a hollow glass ball with a solid tail. The phenomenon may be made use of as follows for determining the composition of a liquid consisting of two substances, *e.g.* a salt solution. A ball is made to correspond to a definite composition, say n per cent, and a measured volume v_1 of the unknown mixture is diluted with measured volumes of water until the ball just floats. We know then that we have an n per cent solution, and that the first solution must have therefore been an $n \frac{v_1 + v_2}{v_1}$ per cent solution, v_2 being the volume of water added.

In order that a conception of the accuracy of this process may be formed, it may be stated that at 18° a change of temperature of 0.03° with a ball of 2.3 cc. gave a very sensible difference. This corresponds to about five units of the sixth decimal, and with care we might go down to one or two units.

Solids.—The measurement of the volume of solids directly from their form can only be carried out in certain cases, when the form is geometrically defined with sufficient exactness and an adequate measurement of the requisite magnitudes may be made. This method is applicable to spheres, cylinders, cones, and prismatic solids. The necessary measurements then resolve themselves into determinations of length, a subject which has already been discussed (p. 22).

The simplest method for irregular solids is to determine the volume directly in a measuring vessel, *e.g.* a broken burette sealed off at the bottom. A liquid is poured into this and its level read off;

then the solid is introduced, air-bubbles being carefully removed, and the new level read. The difference gives the volume required. The accuracy of the method is limited by our ability to read to 0.01 cc. under such circumstances. If the volume displaced is 1 cc., the determination is accurate to 1 per cent.

Water is not a good liquid to use as it attacks some substances and does not wet others easily. In most cases liquid hydrocarbons may be used, *e.g.* benzene, the cheaper commercial toluene, or not too volatile light petroleum. These wet the solids well, and can afterwards be easily removed from them by evaporation.

As above remarked, the method is not an exact one, and should only be used in the few cases where an accuracy of 1 per cent suffices, and a series of determinations have to be made as rapidly as possible.

A process in principle the same has been suggested by Mohr. A beaker has a bridge laid over it from which is suspended a blackened and greased metal point. Water is poured into the beaker until the point and its image coincide in the surface of the water—an operation which can be performed with considerable accuracy. A definite volume of water, greater than the volume to be determined, is removed from the beaker by means of a pipette; the solid is placed in the beaker, and water is added from a burette or divided pipette until the metal point again coincides with its image. The volume of water removed (the capacity of the pipette minus the water added from the burette) is the volume of the immersed solid. However, this method also is inexact. Mohr obtained differences of 0.2 cc. in some experiments, so that the process can only be used for large volumes.

It is much better to make the volume determination of the displaced water indirectly by weighing, and in the first instance this may be done by means of the principle of Archimedes, the loss of weight of the immersed solid being ascertained.

This hydrostatic method can be applied equally to single objects, *e.g.* large crystals, to small fragments, or to powder. In the first case the object is weighed in the air and then in the water, in which it hangs suspended by means of a fine platinum wire, previously freed from grease by ignition. The weighing in water should be done by first of all bringing the balance into equilibrium after the platinum wire has been suspended from the scale pan and dips into the water to the same extent as it will when the solid is attached to it. In this way the error caused by the influence of capillary attraction is most completely eliminated.

The weighings under these conditions are usually much less accurate than when the balance swings freely; the possible error may be estimated at 0.5 mg. We can easily see then what error may be expected in the final result; the possible error is 0.0005 for each cubic centimetre of water displaced, and is thus inversely proportional to the volume of the immersed solid.

If we have to deal with small fragments or with a powder, the tare of a suitable vessel (a small platinum crucible) hanging in water by a platinum wire is determined, the substance is introduced, and the weighing under water repeated. In this case it is best to determine the weight of the substance in air afterwards, by taking the crucible with its contents from the water, the excess of which is then removed by pouring off and allowing to evaporate.

Special attention must be paid to the removal of air-bubbles from small fragments and powders. If the substance will bear it, boiling-out is a good method; this may be done under diminished pressure if a high temperature is prejudicial.

In estimating the specific gravity of solids, particular care must be given to the "definition" of the objects investigated. In most cases we have to deal with crystallised substances, natural or artificial. Now crystals on their formation almost always enclose some of the mother liquor, form internal cavities, etc., so that to procure well-defined, *i.e.* sufficiently uniform, material is a matter of considerable difficulty. Retgers¹ has specially emphasised the gross errors which are due to this circumstance—errors, as a rule, far exceeding those due to other causes. A glance at the data collected with so much patience and completeness by F. W. Clarke² shows how almost inconceivably great the differences are, even with ordinary substances easily to be obtained in the "pure" state. Differences of 3.5 per cent are not rare, and are to be attributed almost entirely to bad selection of material.

Method of Floating.—For our purposes there is no method of determining the density of solids better than the method of floating first used by Davy. Two liquids, one heavier and one lighter than the solid to be investigated, are mixed until a liquid of the same density as the solid is obtained, a point which may be easily recognised by the solid neither sinking nor swimming in it. The density of the liquid is then ascertained by any of the methods already given, most simply with the pipette (p. 94).

Unfortunately this otherwise excellent method is not generally applicable, as we have no liquids of sufficiently high specific gravity. The most suitable is that proposed by Goldschmidt, methylene iodide sp. gr. 3.3; by dilution with benzene, better with toluene or xylene, the specific gravity may be reduced to 0.9. Substances which are attacked or dissolved by these liquids may be investigated in aqueous solutions of potassium mercuric iodide or barium mercuric iodide (up to 3.5). As such substances, however, have not usually a high specific gravity, the limits of the method will scarcely be reached in this direction.

¹ *Zeit. für physikal. Chem.*, 3, 289, 1889.

² *Constants of Nature*, vol. i., 1888.

The process is conducted as follows:—The substance under investigation is introduced in the form of a coarse powder into a small stoppered cylinder, an approximately suitable mixture of methylene iodide and toluene being then added. According as the powder remains on the bottom or rises to the surface more methylene iodide or toluene is added, at first in moderate quantities, finally in drops, until the powder neither sinks nor swims. This state can scarcely ever be exactly reached, for the method is so delicate that even the slow changes of temperature to which the liquid is subject are sufficient to disturb the equilibrium. We must therefore be content with very slow motions up or down, or we may consider the end of the reaction to be reached when some few of the particles sink, while most of them slowly rise.

Retgers (*loc. cit.*) has discussed the details of the process with great minuteness, and has shown in particular that it may be almost without exception assumed that the heaviest particles which rise last are the purest. For the ordinary faults of crystals, enclosed mother liquor and cavities, occasion a diminution of the specific gravity, as the mother liquor is nearly always lighter than the crystalline substance, there being, on the other hand, no apparent cause for an increase of density. Consequently no attention should be paid to the particles which rise first, but only to the heaviest particles.

Gases.—Gases are subject to the law $pv = RT$ where p is pressure, v volume, T the temperature centigrade plus 273, and R a constant, which has the same value for equimolecular quantities of different gases. The constant R is equal to 84,720 for the gram molecule of any gas if the pressure is measured in grams per square centimetre, and equal to 6230 when the pressure is expressed in centimetres of mercury at 0° . For any quantity of gas G the equation $mpv = GRT$ holds good, m being the molecular weight of the gas. From this equation, if four of the five magnitudes p , v , T , m , and G are given, the fifth can be calculated, so that it is of service in answering all questions regarding these magnitudes.

The conception of density or specific gravity is here to some extent defined otherwise than in the case of solids and liquids. Firstly, we term the absolute density a magnitude corresponding to the former definitions; it is the weight of gas contained in unit volume, the weight being expressed in grams and the volume in cubic centimetres. But since the volume of gases varies greatly with pressure and temperature, a normal state must be defined in which the gas is to be measured. The temperature of melting ice, 0° C., is the normal temperature. For normal pressure, that of 76 cm. of mercury at 0° has been chosen; ¹ this, however, is a bad definition,

¹ Since the weight of a mercury column 76 cm. high and 1 cm. in section varies with the latitude and the height above sea-level, attention must be paid to this in exact measurements.—*Cf. Lehrbuch der allg. Ch., I., 165.*

and it would be theoretically much preferable to make the normal pressure equal to 1,000,000 dynes per square centimetre, or very nearly 75 cm. of mercury.

At 0° and under 76 cm. of mercury 1 cubic centimetre of air weighs 0·0012935 g., 1 cc. of oxygen weighs 0·0014301 g., and 1 cc. of any gas of molecular weight m weighs $\frac{m}{32} \times 0\cdot0014301 = 0\cdot00004469m$ g.

These numbers are required when the weight is to be determined from the measured volume. Firstly, the volume v_0 reduced to 0° and 76 cm. is calculated from the volume v measured at the temperature t° and the pressure p (in centimetres of mercury) by means of the equations

$$p_0 v_0 = \frac{pv}{1 + at}, \quad v_0 = \frac{pv}{76(1 + 0\cdot00367t)},$$

and the value thus obtained is multiplied by the factor in question.

Besides this absolute density, another gas or vapour density is in use, which is defined as the ratio of the weights of equal volumes of the gas and of air, both measured at the same temperature and pressure. This ratio, on account of the sameness of behaviour of gases towards temperature and pressure, is independent of the (common) value of these, and therefore is a convenient expression for the relation between volume and mass.

Instead of air any other gas may be used. For chemical purposes an imaginary gas is used which is 32 times lighter than oxygen; for, since the relative densities of gases are in the ratio of their molecular weights, it is simplest to make them equal to the molecular weights. But the molecular weight of oxygen is 32, and 1 cc. of this gas weighs 0·00004469 g. under normal conditions. If, therefore, the weight of a gas is G , and its reduced volume is v_0 , then the molecular weight m is equal to

$$\frac{G}{0\cdot00004469v_0} = 22380 \frac{G}{v_0}.$$

The volume of 32 g. of oxygen in the normal state is 22380 cm. A gram molecular weight of any other gas at 0° and 76 cm. occupies the same space. At the temperature t and the pressure p this general molecular volume is $22380 \frac{(1 + 0\cdot00367t)76}{p}$ cc.

Gas Density and Vapour Density.—The determination of the density of a gas is at the present day an operation seldom to be performed; but the density of a vapour has frequently to be determined.

Of the numerous forms of apparatus proposed for this purpose

that of Victor Meyer is the most convenient and most suitable for determinations accurate to 3-5 per cent. It is based on the circumstance that the vapour produced displaces an equal volume of air of the same temperature and pressure; this air being measured at the atmospheric temperature and pressure. The following is a description of the apparatus of the discoverer, with some slight improvements:—For heating we use a cylinder with a bulb-shaped bottom (Fig. 85), in which a liquid (water, aniline, methyl salicylate, anthracene) is boiled so that the vapours condense in the upper third of the neck. The bottom of the vapour chamber is protected by a little asbestos against breakage when the bulb containing the substance falls in; the neck should be narrow and not widened at the top. A glass rod *t* passes through a short oblique side tube on the neck, being connected with it by a piece of elastic rubber tubing which permits the rod to be drawn back so as to allow the bulb *s* to fall into the heated chamber. On the other side is a short delivery tube connected through a long stout-walled rubber tube (1-2 mm. bore) with a gas-measuring apparatus. This consists of a divided tube *g* of 50-100 cc. capacity which has an arbitrary zero, and is connected with a water reservoir *n* by an india-rubber tube. The reservoir can be moved up and down with a string running over a pulley *r* and through a clamp at *k*, so that equality of pressure may be obtained at any height.

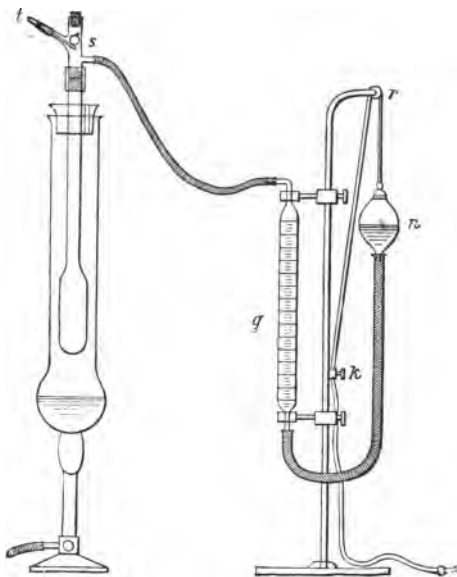

FIG. 85.

To perform an experiment, the bulb containing the substance is brought into its place, the heating started while the stopper at the top is open, the water in the measuring tube brought to the zero division, and when the temperature has become steady the stopper is closed. After a little, the level of the water is observed, if necessary it is readjusted to zero, and then by drawing back the rod *t*, the bulb is allowed to drop. Air at once begins to pass over into the measuring tube, the water in *n* being kept at the same level as the water in

the tube. If after a few minutes the level does not change, it is read off. The volume of air found is equal to the volume of vapour reduced to the temperature of the measuring tube.

The substance, if a solid, may be introduced in lumps, or pastilles made by a press if necessary, or in little cups made of Wood's metal (Victor Meyer). Liquids are sucked up into small double-pointed weighed bulbs, the points being then sealed off; this operation is quite easy if the points are narrow and thin in the wall. It is desirable to fill the bulbs as full as possible, so that they may break by the expansion of the liquid, and not by the formation of vapour. Another very useful plan is to stop up one end before filling by dipping it into fused Wood's metal, and then fill in the ordinary way by alternate heating and cooling, the second point being afterwards sealed off. The tare of bulb must, of course, be ascertained after the metal plug is fixed in.

The sealing off of the bulbs may be done by simply holding the end in the flame and letting it fall together, or by softening the tube at a suitable place and drawing off the end with forceps. The latter method secures a proper seal; but it must not be forgotten in weighing the filled bulb to weigh the drawn-off point with it, after any adhering liquid has been removed by warming.

If there is any difficulty in sealing a bulb of the ordinary shape without loss, the more convenient form shown in Fig. 86 may be used. The bent arm must be sealed off short, say at *a*, to prevent the bulb sticking in the tube of the apparatus. During the filling by suction the arm *b* should dip vertically into the liquid.

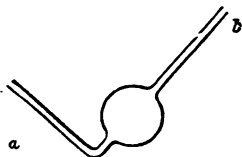

FIG. 86.

Determination and Correction of *t*, *p*, and *v*.—In Meyer's process the temperature of the vapour chamber need not be known; it has only to remain constant. In the equation the only temperature which must be ascertained is that at which the volume of the air is read off. A thermometer should be suspended beside the measuring tube, and read simultaneously with it. An error of a degree in the temperature causes an error of 0.3 per cent in the density.

The barometer must be corrected for temperature, both as regards the mercury and the scale (p. 78). This correction usually amounts to about 0.2 cm. on the volume, *i.e.* somewhat less than 0.3 per cent of the whole value. Further, the vapour pressure of water (see Table) must be deducted from the barometric pressure. It changes at 18° by 1 cm. per degree, so that the temperature of the gas must be determined much more exactly on this account than on account of its own expansibility.

The volume of the measurer is checked by weighing out with water with the corrections for buoyancy and expansion by heat.

Glass vessels change their volume by 0.00003 per degree, the result of which vanishes for ordinary atmospheric temperatures.

With other methods of vapour density determinations, the measurement of temperature is made by means of a thermometer or

VAPOUR PRESSURE OF WATER

From -19° to 100° in Millimetres of Mercury

<i>t.</i>	<i>p.</i>	Δ .	<i>t.</i>	<i>p.</i>	Δ .	<i>t.</i>	<i>p.</i>	Δ .	<i>t.</i>	<i>p.</i>	Δ .
-19	1.029	0.091	+10	9.140	0.627	+40	54.87	3.00	+70	233.31	10.31
18	1.120	0.099	11	9.767	0.665	41	57.87	3.15	71	243.62	10.68
17	1.219	0.099	12	10.432	0.665	42	61.02	3.29	72	254.30	11.08
16	1.325	0.106	13	11.137	0.705	43	64.31	3.45	73	265.38	11.49
15	1.439	0.114	14	11.884	0.747	44	67.76	3.60	74	276.87	11.89
14	1.562	0.123	15	12.674	0.790	45	71.36	3.77	75	288.76	12.33
13	1.694	0.132	16	13.510	0.836	46	75.13	3.94	76	301.09	12.76
12	1.836	0.142	17	14.395	0.885	47	79.07	4.12	77	313.85	13.20
11	1.988	0.152	18	15.330	0.935	48	83.19	4.30	78	327.05	13.68
			19	16.319	0.989	49	87.49	4.49	79	340.73	14.14
			20	17.363	1.044	50	91.98	4.68	80	354.87	14.64
-10	2.151	0.163	21	18.466	1.103	51	96.66	4.89	81	369.51	15.13
9	2.327	0.176	22	19.630	1.164	52	101.55	5.10	82	384.64	15.65
8	2.514	0.187	23	20.858	1.228	53	106.65	5.32	83	400.29	16.18
7	2.715	0.201	24	22.152	1.294	54	111.97	5.55	84	416.47	16.72
6	2.930	0.215	25	23.517	1.365	55	117.52	5.77	85	433.19	17.28
5	3.160	0.230	26	24.956	1.439	56	123.29	6.02	86	450.47	17.85
4	3.406	0.246	27	26.471	1.515	57	129.31	6.27	87	468.32	18.44
3	3.669	0.263	28	28.065	1.594	58	125.58	6.52	88	486.76	19.05
2	3.950	0.281	29	29.744	1.679	59	142.10	6.78	89	505.81	19.66
1	4.249	0.299	30	31.51	1.77	60	148.88	7.07	90	525.47	20.30
0°	4.569	0.320	31	33.37	1.86	61	155.95	7.34	91	545.77	20.94
+1	4.909	0.340	32	35.32	1.95	62	163.29	7.63	92	566.71	21.62
2	5.272	0.363	33	37.37	2.05	63	170.02	7.94	93	588.83	22.31
3	5.658	0.411	34	39.52	2.15	64	178.86	8.24	94	610.64	23.02
4	6.069	0.411	35	41.78	2.26	65	187.10	8.57	95	633.66	23.74
5	6.507	0.438	36	44.16	2.38	66	195.67	8.89	96	657.40	24.48
6	6.972	0.465	37	46.65	2.61	67	204.56	9.23	97	681.88	25.25
7	7.466	0.525	38	49.26	2.74	68	213.79	9.58	98	707.13	26.03
8	7.991	0.557	39	52.00	2.87	69	223.37	9.94	99	733.16	26.84
9	8.548	0.592									

pyrometer. The influence of an error in the temperature is the smaller the higher the temperature is. At t° it is $\frac{1}{273+t}$ of the density for every degree. The volume of glass vessels increases 0.3% for each hundred degrees, so that the correction need only be made above 100° .

Dumas's Method.—Some grams of the substance are placed in a narrow-necked bulb of 30 up to 200 cc. capacity, which is then

immersed in a bath having a temperature about 20° higher than the boiling point of the substance. After the vapour has ceased to escape, the neck is heated along its whole length to vaporise any liquid remaining in it and is then sealed off, the temperature and pressure being noted. The bulb is weighed before the experiment, a sealed bulb of the same volume being used as counterpoise to eliminate errors of buoyancy, and again after the experiment, when sealed off and cleaned, the drawn-off point being of course added. The increase of weight is equal to the weight of the vapour G minus the weight of the air in the bulb during the first weighing. To ascertain this, the temperature and pressure must be noted at the time of this weighing, and also, in exact experiments, the humidity of the air. The volume of the vapour is determined by opening the bulb under water, and finding the increase of weight.

This method of finding the weight of vapour is very unpractical and should always be avoided if possible. As Dumas's process is usually applied to somewhat difficultly volatile substances, which have a very small vapour pressure, if any, at the atmospheric temperature or 0° , it is best after sealing off the neck to cool the end of it so as to condense the vapour at the tip, and to seal off this end again with the substance in it. To determine G , it is then only necessary to weigh the drawn-off portion containing the substance, to cut it, and, after the substance has been driven off by heating, to weigh again. In this way a great number of possible sources of error are avoided.

In some cases the direct determination of weight may be replaced by an analytical process which often permits of much more accurate measurements than the weighing. For instance, if we are to determine the vapour density of iodine, the quantity present in the bulb as vapour may be estimated by washing out with potassium iodide solution and titrating with thiosulphate, much more accurately than by direct weighing. For in this case we can measure to one drop (1/40 cc.) with a fiftieth normal solution, *i.e.* measure 0.06 mg. of iodine, whilst weighing the bulb and determining the weight of air can scarcely be done more accurately than to 1 mg. The conditions for substances with smaller molecular weights are still more favourable. For instance, if, in the vapour density of phosphorus, we convert this substance into magnesium pyrophosphate, then, instead of the clumsy weighing of a large bulb, we have the convenient weighing of a precipitate 3.5 times as heavy as the phosphorus.

Gay-Lussac and Hofmann's Method.—A tube 2.3 cm. bore, and about 90 cm. high (Fig. 87), divided lengthwise into millimetres, and calibrated for volume, is carefully filled with mercury and set upright in a mercury trough. A jacket of the form shown in the figure (somewhat different from the customary form) is placed round the tube. This jacket is narrowed at the foot so as just to leave free passage to the tube, and is closed above with a hollowed-out stopper,

which fixes the tube in the axis of the jacket, and through which the vapour tube *d* passes. The jacket is sunk a few centimetres into the

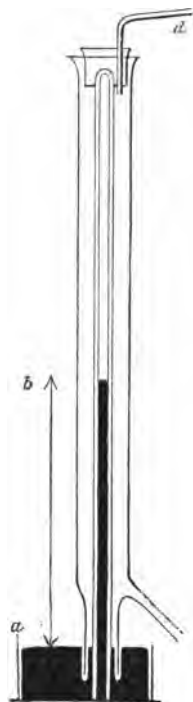

FIG. 87.

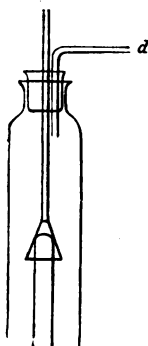

FIG. 88.

mercury, and may be connected with the inner tube by a short piece of india-rubber tubing slipped over both.

If the jacket is to be used for tubes of different lengths, a movable rod may be inserted through the stopper, the lower end being funnel-shaped so as to hold the tube fast (Fig. 88). To perform the experiment, the weighed substance is brought into the tube in a small bulb, the jacket being then heated by the vapour of a suitable liquid passed in through *d*. As the vapour of the substance in the tube is under reduced pressure, the temperature of the jacket need never be above the ordinary boiling point of the substance, and may be much lower if we choose proper conditions, *i.e.* a large space and a small amount of substance.

The temperature is usually given with sufficient accuracy by the boiling point of the liquid used for heating. The volume is read off on the scale of the tube, attention being paid to the dilatation of glass. The pressure is equal to the barometric pressure minus the

height of the mercury column *ab*, which, being read off on the heated millimetre scale, must be reduced to standard conditions. Above 100° the vapour pressure of mercury has to be taken into account.

VAPOUR PRESSURE OF MERCURY

In Millimetres, according to Regnault and Hertz (*a*) and Ramsay and Young (*b*)

<i>a.</i>		<i>b.</i>		<i>a.</i>		<i>b.</i>		<i>a.</i>		<i>b.</i>	
0°	0·0002	...	100°	0·285	0·270	200°	18·25	17·02	300°	242·2	246·8
10	0·0005	...	110	0·470	...	210	25·12	...	310	299·7	304·8
20	0·0013	...	120	0·779	0·719	220	34·9	31·96	320	368·7	373·7
30	0·0029	...	130	1·24	...	230	45·4	...	330	450·9	454·4
40	0·007	0·008	140	1·93	1·763	240	58·8	...	340	548·4	548·6
50	0·014	0·015	150	2·93	...	250	75·8	...	350	663·2	658·0
60	0·028	0·029	160	4·38	4·013	260	96·7	...	360	797·7	...
70	0·051	0·052	170	6·41	...	270	123·0	123·9	370	954·7	...
80	0·093	0·093	180	9·23	8·535	280	155·2	157·4	380	1139·7	...
90	0·163	0·160	190	13·07	...	290	194·5	198·0	390	1346·7	...

Calibration of Measuring Tubes for Gases.—Gas-measuring tubes like other similar instruments should be calibrated as far as possible under the same conditions as those to which they are exposed when in use. With the measuring tube of Meyer's apparatus (Fig. 85, p. 101) the displaced air is collected over water, and all the rules given on p. 87 for the calibration of burettes are therefore valid. Measuring tubes for Hofmann's apparatus must, on the other hand, be calibrated dry with mercury. Bunsen's method of doing this is to fill with mercury free from air-bubbles a short, thick-walled tube of 2-10 cc. capacity (according to the size of the tube to be calibrated), closed at one end and ground flat at the other, and after pressing a plane ground glass plate on it, to empty the contents into the inverted tube. The air-bubbles in this must then be removed by shaking the tube, and the position of the mercury read off on the millimetre scale. A second portion of mercury is then added, read off, and so on. The volume of the measuring cup is known by weighing out with mercury (p. 84), so that a table may be constructed to give the volume corresponding to each reading. For convenient use of the table, the volumes corresponding to the whole centimetres of the scale should be calculated, small interpolation tables like those used for logarithms being then made in order that the values for the millimetres and their tenths may be easily ascertained.

Before calculating out the table, attention must be paid to the circumstance that the mercury meniscus during the calibration is turned the other way from the position it occupies when the tube is in use. The volume in the last case is therefore greater by twice the amount of the annular space between the meniscus and its horizontal

tangent plane. To apply this correction we make use of the following table, due to Bunsen :—

Diameter of tube . . .	1.4	1.5	1.6	1.7	1.8	1.9	2.0	2.1	cm.
Correction	0.114	0.106	0.096	0.088	0.076	0.064	0.052	0.040	cm.

The table is used by subtracting the numbers given as corrections, in centimetres, from those read off on the tube during calibration, if, as is customary, the graduation starts from the closed end as zero. The signification of the correction numbers is the following :—If we imagine the lower meniscus (Fig. 89) flattened out into a plane, this, corresponding to the line *c*, would represent the true cylindrical volume of the mercury in the tube, and the correction for the meniscus would be equal to *ac*. But if the tube is used when inverted, then there is in addition the meniscus correction *ba* to be applied, so that the total correction is *bc*. It is this magnitude *bc* which is tabulated above from Bunsen's direct measurements.

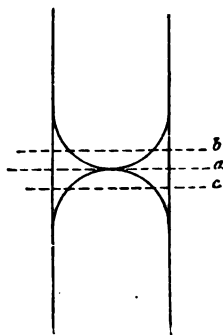

FIG. 89.

CHAPTER IX

DILATATION, BOILING POINT, VAPOUR PRESSURE, AND CRITICAL CONSTANTS

Dilatation of Liquids.—A vessel resembling a thermometer, and called by Kopp a dilatometer, is used for measuring the influence

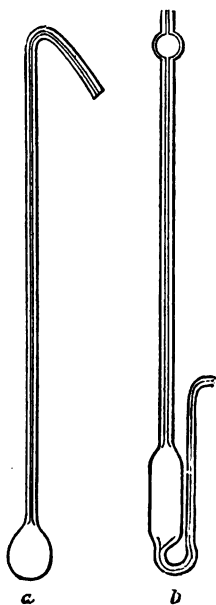

FIG. 90.

of temperature on the volume of liquids. The simplest form, due to Kopp, is shown in Fig. 90, *a*. It consists of a pretty wide capillary, ending below in a bulb, and bent over like a siphon above. The instrument is filled first by alternate heating and cooling, and finally by boiling the liquid in the bulb while the free end dips into a vessel containing the liquid. By heating the upper portion of the capillary down to the point at which the liquid should terminate, the tube is brought into a state for observation.

An improved form which I have used is shown in Fig. 90, *b*. It differs from the first by having a second capillary attached to the bulb and bent upwards. The filling can thus be performed more conveniently by immersing the end of the inverted dilatometer in the air-free liquid and sucking up through the second capillary. The instrument is again brought upright, liquid is allowed to flow out until the proper level is reached, after which the short capillary is closed.

When working with aqueous solutions I have simply closed the tube with a little sealing-wax. In the case of organic liquids this cannot be used, so that the closing must be effected by a small stop-cock or a plate pressed against the opening of the widened tube by means of a pressure screw working in a hoop (Fig. 91), a piece of thin gutta-percha

being laid between the tube and the plate. The hoop has its arms made with semi-cylindrical ends, which clasp the neck and are fixed in position by binding with thin wire. This arrangement is better than a stopcock, which can scarcely be kept from leaking on account of the varying temperature, and has besides in general a greater error from the neglected space within it.



FIG. 91.

A third form of dilatometer is shown in Fig. 92, which obviates the difficult and uncertain correction of the exposed thread, inherent in all dilatometers with long stems, by having the tube so shortened that the whole apparatus may be immersed in the bath used for heating.

For this purpose the tube is provided with four to six enlargements, between which there are marks or short scales. In using such a dilatometer the liquid is brought in succession to the separate marks by changing the temperature, which is noted at each stage. By employing a small thermostat it is possible to retain the temperature so long constant that the equalisation of temperature between the thermometer and dilatometer is certain. It is more convenient to provide the tube with several divisions (ten at most) instead of a single mark, as in that case the regulation of the temperature has only to be approximate.

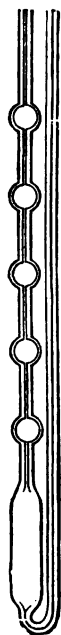

FIG. 92.

To make a dilatometer of the form given in Fig. 90, a tube of the proper dimensions is selected and tested as to its uniform bore by introducing a column of mercury some 6 cm. long, and measuring it with a compass at different parts of the tube. If the length of the mercury thread remains sensibly the same, the tube is graduated into millimetres on the dividing engine, after which it is calibrated (p. 47). The bulb and the second capillary are then attached. The dilatometer is filled with mercury, the level at 0° and 100° being read off. The weight of the mercury is then determined, and also the weight of a pretty long mercury thread, whose length has been read at different positions in the tube. The correspondence between the lengths, after reduction by the calibre correction, gives us a measure of the accuracy of the calibration. The temperature of the room must be taken during the last operation.

To calculate the constants of the dilatometer, the length l of the weighed mercury thread is reduced to 0° C. by means of the apparent dilatation of mercury in glass, 0.00015, and the weight is divided by this length, the quotient z being the weight corresponding to one scale-division. From the weight of mercury, which at 0° filled the dilatometer to the division d_0 , the weight zd_0 is subtracted, the result giving the weight G of mercury which fills the dilatometer to the

zero of the scale at 0° . This weight divided by z gives the capacity I_0 of the dilatometer up to the zero-point, expressed in volumes of a scale-division of the tube as unity. The magnitude I_0 is a measure of the sensibility of the instrument.

All observations are calculated by adding the corrected scale value to I_0 , from which the corresponding volume in the above-mentioned unit is obtained. The increase of volume of the dilatometer by heating must still be added. To determine the coefficient of expansion of the dilatometer, we employ the two readings of the mercury at 0° and 100° . Calculating the two volumes in the above way and dividing the volume at 100° by the volume at 0° , a number is obtained which is approximately 1.015 or 1.016, and represents the difference between the dilatation of the mercury and that of the glass. In very exact determinations the state of the barometer must be taken into account in order to get the real boiling point; if this should differ from 100° , the reading of the dilatometer for 100° must be corrected. The coefficient of expansion of ordinary Thuringian glass lies between 0.000028 and 0.000031; for Jena thermometer glass it is 0.000024.

In order to calculate the temperature correction of the dilatometer conveniently, it also should be expressed in scale-divisions. For this purpose the value $I_0 + d_0$ is multiplied by 1.01821, and after deduction of I_0 there is obtained the point at which the mercury would have stood at 100° had the glass not expanded. If d_{100} , the real position of the mercury at 100° , is subtracted from this value, $1.01821(I_0 + d_0) - I_0$, we obtain the number of scale-divisions by which the dilatometer has expanded between 0° and 100° . The hundredth part of this, b , is the correction for each degree of temperature, so that to every determination of volume at t° there must be added bt .

Finally there is the correction for the exposed column. From the reading before it is corrected for the expansion of glass we obtain the apparent expansion of the liquid in glass by calculating from the mean temperature of the column (ascertained by a thermometer hung up beside it) up to the temperature of the dilatometer, the volume at the mean temperature being taken as unity.

The length of the exposed column is multiplied by this apparent expansion, the correction being thus again obtained in scale-divisions. This last correction is the most troublesome of all, as the determination of the mean temperature of the thread is very uncertain, and causes relatively large errors. On this account all very exact measurements of the dilatation of liquids must be so conducted that the whole tube is at the temperature considered.

The above description applies to the dilatometer in Fig. 90. If the form in Fig. 92 is to be used, the mercury capacity of the dilatometer and the volumes between the different marks must be

determined—best by running out and weighing. The coefficient of expansion is most easily obtained by completely filling the dilatometer with mercury at 0° , ascertaining the weight, and then weighing the mercury expelled by expansion up to 100° . The weight of the mercury may be used as a preliminary measure of the volume, everything being expressed in weights of mercury measured at 0° , instead of in scale-divisions as before.

In this way we obtain a table of corresponding volumes and temperatures, the first being expressed in an arbitrary unit. If the volume is divided by the value observed at the normal temperature, then we have all volumes in terms of the volume at this temperature as unity.

To find the relation between v and t for all intermediate temperatures from the individual corresponding values, these are either plotted as a curve on co-ordinate paper, or a formula, $v_1 = v_0(1 + at + bt^2)$, is calculated. For measurements of ordinary accuracy two terms are sufficient, a term with t^3 being unnecessary.

Molecular Volume of Liquids at their Boiling Points.—On account of the comparison of the molecular volumes of liquids at their boiling points under normal pressure having been introduced by Kopp, this magnitude is very often determined. The determination can be made by the dilatometric method, as it is usually not difficult to heat the liquids in the dilatometer several degrees above their boiling points without boiling taking place. Methods exist, however, which give the magnitude in question directly.

The principle of these methods is due to Ramsay; it consists in filling a suitable pyknometer with the liquid and heating it in its own vapour at the required pressure. Of the forms of pyknometer given by Ramsay, Schiff, and Lothar Meyer, those of the two last are the most convenient. Schiff uses a pyknometer which only differs from the forms of Fig. 77 or Fig. 78 by the narrow part of the neck being somewhat longer, and having a divided scale instead of a mark. It is heated in the vapour, any air or gas bubbles are removed by tapping or with a platinum wire, and then by means of a pipette (Fig. 79) so much liquid is taken out that the meniscus comes on the scale. After the exact position has been read off, the pyknometer is taken out, closed, cooled, and weighed. A preliminary determination of the tare, the coefficient of expansion, and the volume of the body and of the divided neck, must be made in order to obtain sufficient data for the calculation. If p is the weight of the empty pyknometer, g_0 the weight of mercury to the beginning, and g_s to the end of the scale, which contains s divisions, then the capacity of the pyknometer I_0 at 0° is $0.007356g_0$, and the volume i_0 of each scale-division is $0.007356 \frac{g_s - g_0}{s}$. If the reading has been to the division n , the capacity at 0° is $I_0 + ni_0$; at the temperature t it is $(I_0 + ni_0)(1 + \beta t)$

where β is the coefficient of expansion of the glass, determined in the usual way. The correction for the meniscus must not be forgotten, as a convex meniscus is obtained with the mercury in calibrating the instrument, and a concave one on using it for other liquids. With a moderately small neck we may, as a first approximation, consider both to be hemispheres, so that for each we must add or subtract one-third of the radius of the neck on reading the scale.

Still more convenient for manipulation is the form of pyknometer (Fig. 93) suggested by Lothar Meyer and described by Neubeck.¹



In this instrument the neck takes the shape of a narrow tube bent first downwards, and then sharply upwards at the end. The apparatus is brought into the liquid boiling in a flask, and filled by alternate increase and decrease of pressure while the lower part is immersed in the liquid. When the filling has been done without any air-bubble remaining behind, the apparatus, which is hung on a stout wire, is raised, allowed to assume the temperature of the vapour, cooled, cleaned, and weighed. The capacity and dilatation are determined in the ordinary way.

Determination of Boiling Points.—The numerical values of the boiling points of definite substances are mostly obtained during their preparation or purification, the temperature of the vapour being observed as they distil. The ordinary rules for thermometry must be attended to, a corrected thermometer being employed, and the error of the exposed column avoided.

The temperature of the boiling liquid can only be taken as the real boiling point when very special precautions are observed, for slight superheating is scarcely avoidable. The bulb of the thermometer must on this account be brought into the vapour, not into the liquid. The height of the barometer must be observed in determining the boiling point. Platinum clippings introduced into the vessel are useful in facilitating the ebullition. Hydrogenised palladium may also be used, and I have found steatite very active in this respect. Beckmann's method of sealing in a piece of stout platinum wire into the bottom of the flask with the help of enamel (p. 71) is also serviceable.

Determination of Vapour Pressures.—From the recent investigations of Ramsay and Young, Kahlbaum, and others, it appears that the so-called statical method of measuring vapour pressures gives fairly exact results only with great difficulty. This comes from the impossibility of obtaining perfectly pure substances, traces of impurity in the liquids having an extraordinarily great influence on the measurement of the pressure exerted by a given substance at a given temperature in vacuo, on account of the

¹ *Zeit. f. physik. Chem.*, 1, 652, 1887.

very small quantity of the substance vaporised, especially at low temperatures.¹

The so-called dynamical method is much more practical, the substances being boiled under a known pressure, and the boiling point determined. This process has been worked out especially by Ramsay and Young, who perform it as follows:—The bulb of a thermometer is wrapped in a suitable porous material, asbestos or cotton-wool, and the instrument is fixed air-tight by means of a stopper into the boiling tube *S* (Fig. 94) with a side tube *r*. The tube of a tap funnel *H* passes through the same stopper, and the drawn-out point is brought close to the thermometer bulb. The tube *r* is connected with a cooled receiver and a large space serving as air reservoir to deaden any alterations of pressure. The boiling tube is placed in a bath with a temperature above the boiling point of the liquid under the given pressure, which is regulated and measured as described on p. 73 *et seq.* The liquid in *H* is first made to wet the thermometer bulb by opening the tap, and then regulated so that as much flows in as distils slowly over through *r*.

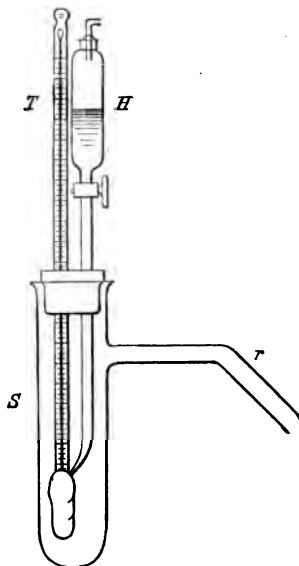

FIG. 94.

For the application of Beckmann's boiling point apparatus to such determinations, see below.

Method of Evaporation.—As Regnault and Magnus have shown, the vapour pressure of a volatile liquid in a space filled with an indifferent gas is very nearly equal to the vapour pressure in vacuo, and the more nearly is it so, the smaller is the pressure and therefore the density of the vapour. From this there results a convenient process for estimating the ratio of the vapour pressure of very similar liquids, in especial of solutions.

The most obvious process is to pass a known volume of gas (atmospheric air) through the liquid and calculate the pressure of the vapour from the weight which passes over. This weight can be got either from the loss of weight of the whole liquid, or the vapour may be removed in a suitable way from the gas and weighed directly. If V is the volume of air, g the weight of vapour, and m its molecular weight, the pressure is obtained from the equations

¹ Cf. Tammann, *Wied. Ann.*, **32**, 683, 1887.

$$p_g = 84700 \frac{gT}{mv}, \quad \text{and} \quad p_h = 6229 \frac{gT}{mv},$$

where p_g is the pressure in gravitation units (g. per cm.²) and p_h the pressure in centimetres of mercury. The equation is derived from $pv = RT$, where for p_g the constant R has the value 84700, and for p_h the value 6229, 1 gram molecule of the vapour being considered.

In exact calculations it is to be remarked that for v we do not put the volume of air alone, but this volume plus the volume of the vapour reduced to the same pressure, if, as is mostly the case, the total pressure has remained constant (equal to the atmospheric pressure) during the experiment, and not the total volume. This correction is easily obtained from $pv = \frac{g}{m}RT$, being $v = 6229 \frac{gT}{mb}$, where b is the barometric height in centimetres. The corrected formula is thus for centimetres of mercury

$$p_h = 6229 \frac{gT}{m \left(v + 6229 \frac{gT}{mb} \right)}.$$

Such absolute determinations of pressure are, however, very seldom made, as the measurement of the volume of air is difficult, since from 2 to 100 l. must be taken for a sufficient quantity of liquid to be vaporised. The determination of a ratio of vapour pressures in this way is much more convenient. Details as to this will be given under the vapour pressure of solutions (Chap. XIV.)

Critical Temperature.—Of the three critical constants, the critical temperature may be easily observed on account of the characteristic phenomena accompanying it. The exact measurement, however, is difficult owing to the difficulty in maintaining the somewhat high temperature sufficiently constant to secure equality of temperature between the thermometer and the liquid.

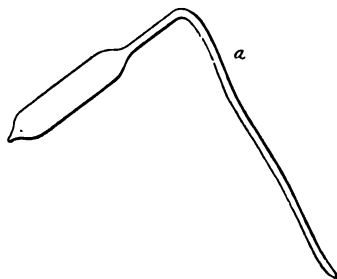

FIG. 95.

0.7 mm. Several tubes are filled, the quantity of liquid in each being varied from one-half to three-fourths of the volume.

The liquid is enclosed in a small tube 2-3 mm. wide and 30-40 mm. long, drawn out first as in Fig. 95, filled air-free with the liquid to about two-thirds of its volume by alternate heating and cooling, and then sealed off at a . If the capillary is moderately thick-walled it will resist a very high pressure; the tube itself need be no thicker than

The heating of the tubes is conducted in an air-bath (Fig. 96) consisting of three iron or copper boxes provided with mica windows on opposite sides to permit observation of the interior. The middle box is longer than the inner one, and has several sheets of wire gauze in its lower portion, to secure better distribution of the heated gas, and thus uniformity of temperature. The whole is surrounded by a third box covered with asbestos mill-board. There are several shuttered openings in the lid for the purpose of changing the air, and also vertically arranged holes in the boxes for the admission of the thermometer. The tube containing the substance is hung up in the inner box by two wires. Stoppers to resist the highest temperatures may be made from asbestos well mixed up with water and then pressed.

It is probable that the air-bath described by Lothar Meyer¹ will answer well for the same purpose. This bath consists of three concentric cylinders heated by a ring-shaped burner, the gases from which have to pass several times up and down through the bath, and surround the

inner space uniformly. Side windows of mica are used for observing. The bottom might be made of a double mica plate through which the interior could be both lighted up and observed by means of a mirror. I have no personal experience of these baths.

The observation is repeated several times in the same tube with both rising and falling temperature, the disappearance of the meniscus and the clouding being taken as the points to be observed, and the mean of the two readings accepted. The other tubes are then examined.

Theoretically speaking, these temperatures are not exactly the critical temperature, for the liquid can only by chance and in very exceptional cases fill the tube to such an extent that the capacity corresponds to the critical volume; the volume is usually somewhat larger. Since, however, the isotherm at the critical temperature with p and v as co-ordinates has the form given in Fig. 97, the tangent being horizontal at the critical point, *i.e.* parallel to the axis of

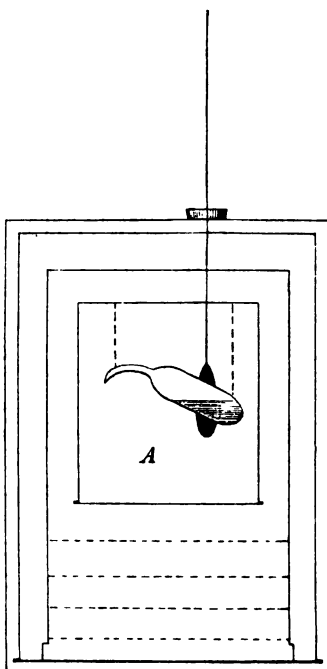

FIG. 96.

¹ *Berichte*, 16, 1087, 1887.

volumes, it is evident that a relatively large change of volume will only cause a very slight change of pressure, for at the critical point itself $\frac{dp}{dv} = 0$, *i.e.* the change of volume has no influence on the pressure. An approximation to the critical volume is thus sufficient to reduce the error in the critical temperature to a very small amount. (Let the reader draw the critical isotherm, say of carbonic acid, from the existing data, and determine the amount of this error.)

The observations made on p. 44 with regard to the reading of the thermometer must be borne in mind. Short thermometers with a range of 50° are best, as they can be almost entirely immersed in the air-bath.

Critical Pressure.—The determination of this magnitude has

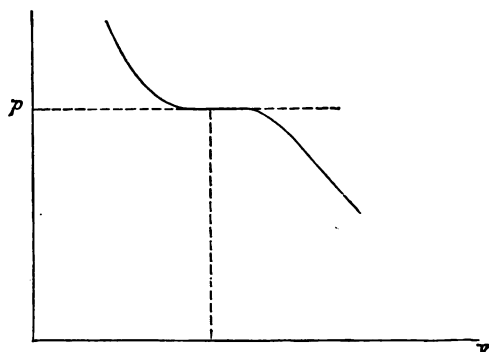

FIG. 97.

hitherto been considered difficult; but the following process worked out in my laboratory by Altschul makes it more convenient than the measurement of the critical temperature.

The pressure pump *P* (Fig. 98) is made of iron, and a screw of the same metal passes into it through a stuffing box. The pump is filled with paraffin oil, and to it two copper capillaries are attached—one going to a spring manometer *M* filled with oil, the other being connected with a stout-walled glass tube, 40 cm. long and 1.2 mm. wide. The glass tube is air-free and half-filled with the liquid to be investigated, a thread of mercury 10 cm. long being then introduced. It is cemented into the soldered mouthpiece of the copper capillary by means of sealing-wax, is surrounded by a tube 1.5 to 2 cm. wide, and fixed obliquely.

By screwing up the pump, the liquid is subjected to a pressure probably somewhat below the critical value, and the upper 5-7 cm. of the tube are heated by a burner placed beneath. Vapour appears

after some time. The heating is continued for a little and the pressure slowly increased, the meniscus being observed all the while. At the instant the critical pressure is reached the meniscus disappears, and reappears on diminution of the pressure to the critical value. The experiment can be repeated several times very rapidly and the mean of the observations taken. No care need be expended on the regulation of the temperature, if the tip of the tube is above the critical temperature, for, since the lower part of the tube is cold, there must necessarily be a place exactly at the critical temperature,

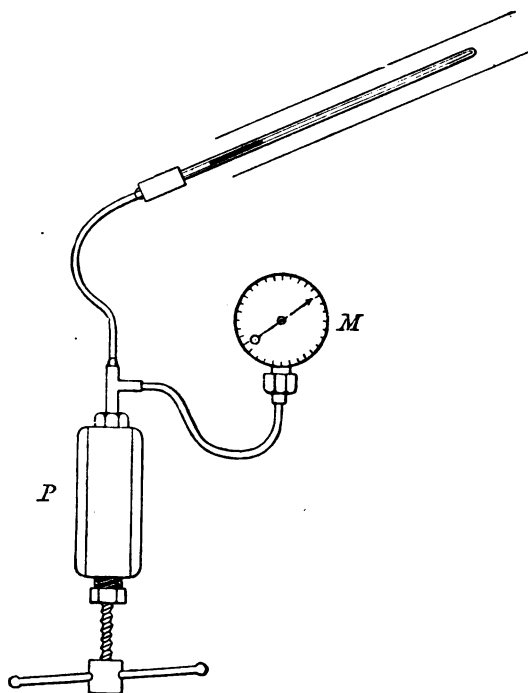

FIG. 98.

and at this place the phenomena described occur. If the temperature changes, this place travels to another point of the tube, everything else remaining unchanged.

Critical Volume.—There is at present no simple method of determining the critical volume. The safest plan is to determine the corresponding values of the density as vapour and liquid for a number of temperatures in the neighbourhood of the critical point. If these values are tabulated as co-ordinates, a curve resembling a parabola is

obtained (Fig. 99). The mean values $\bar{m}_1, \bar{m}_2, \dots$ of the densities belonging to each temperature are found to lie very exactly in a

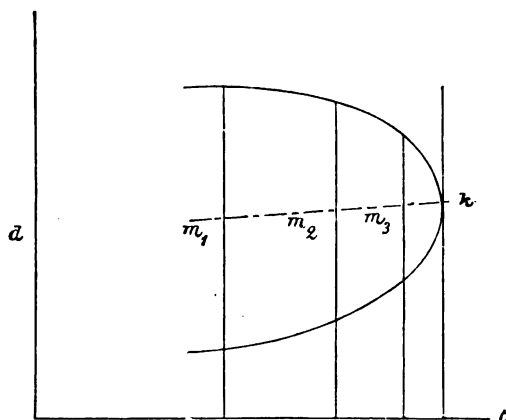

FIG. 99.

straight line,¹ whose point of intersection with the ordinate of the critical temperature gives the reciprocal of the critical volume.

¹ E. Mathias, *Comptes rendus*, **115**, 35, 1892.

CHAPTER X

CALORIMETRY

THE heat which appears or disappears during chemical or physical processes is usually measured as a product of the change of temperature of the measuring apparatus (the calorimeter) into its heat capacity, and the accuracy of the result depends in the same way on the accuracy of each of these magnitudes. It is, therefore, useless to measure the change of temperature with great exactness if the heat capacity is not well known, and conversely.

Calorimetric Thermometers.—Chapter IV. is to be consulted for the measurement of temperature. For calorimetric purposes thermometers divided into hundredths of a degree are most suitable, although in special cases they may be divided into thousandths. It is convenient to have the capillary ending above in a wide chamber after the manner suggested by Beckmann (Fig. 100). By leaving suitable quantities of mercury in this chamber, the thermometer may be used for any small range of temperature within wide limits. The range of the instrument is from 5 to 10 degrees. To set it for 15° - 20° , it is warmed to 21° - 22° , as registered by another thermometer, and brought down smartly in the vertical position on the palm of the hand or a thick rubber support, the mercury in the upper part of the chamber being thereby broken off. If the thread turns out to be too short, the thermometer is warmed until the mercury reappears in the chamber, and all the mercury is then united centrifugally in the upper portion by giving the top of the instrument a swing forward. It is now warmed to the desired temperature and the breaking off conducted as before.

Calorimetric thermometers must be calibrated and the value of a scale degree determined. The last operation is best done by comparison with a standard thermometer, as large an interval of temperature as possible being measured.

As these calorimetric thermometers are only used for measuring changes of temperature, and not for determining absolute values, it is superfluous to provide them, as is often done, with the freezing point,

by the help of a small enlargement on the capillary, as this increases the difficulty of construction and so raises the price.

To obtain accurate results it must not be neglected to read with the temperature rising, and to tap the thermometer before reading, in order to overcome capillary resistance.

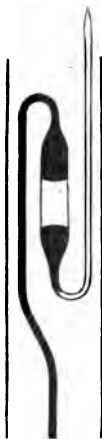

FIG. 100.

Calorimeters.—The difficulty of procuring large quantities of pure substances for calorimetric work, necessitates the employment of small quantities and correspondingly small calorimeters; but it must be emphasised that the use of too small calorimeters is one of the chief sources of error in the older experiments. From Berthelot's observations bearing on this point, it is not practical to reduce the volume of the calorimeter below 500 cc.; with smaller calorimeters the influence of the environment on the temperature is so great that the correction for radiation cannot be calculated with certainty.

The material of the calorimeter depends on how it is to be employed. Platinum is the best of all on account of its permanence and its small heat capacity. For a great many purposes, however, nickel may be substituted, *e.g.* with water, and neutral or alkaline solutions. Silver calorimeters, which may be gilt where they come in contact with solutions, are very widely applicable.

The shape of the calorimeter is almost without exception cylindrical, with a circular or sometimes an elliptical section. It is in all circumstances advisable to provide the calorimeter with a lid of suitable material in order to hinder, as far as possible, evaporation of the aqueous contents—a cause of considerable variations of temperature. For the same reason the cylinder should be made higher than it is wide.

The stirrer is a very important adjunct of every calorimeter, its task being to effect a constant mixing of the contents, so as to secure at each instant uniformity of temperature as nearly as possible. The stirrer has different forms according to the general construction of the calorimeter. The simplest form is a plate, nearly filling the section of the calorimeter, with the necessary holes for the thermometer and other pieces of apparatus in the interior. The stirring is much more effective if the plate has H-shaped openings cut in it, the two flaps being bent out of the plane of the plate in opposite directions. By help of these flaps the stirrer generates oblique currents, which effect a very complete mixing, especially if the neighbouring H-holes are placed so that their currents cross each other.

Berthelot recommends a screw stirrer which is greatly praised; it is at least more difficult to make and therefore dearer.

Only in single experiments is the stirrer worked by hand; in

continued work mechanical driving power is desirable. For this purpose powerful clockwork, small electromotors, turbines, etc., will serve (cf. p. 65), an endless band being carried from them to a speed pulley. By selecting the proper diameter on the pulley the necessary rate may be obtained from a given speed of the motor. To regulate the length of the stroke an adjustable crank is used, which may be constructed in various ways. A simple and convenient mode is to fix on the pulley a small metal strip pivoted at *a* (Fig. 101) and clamped fast there by a nut, the pin of the crank being at *b*. The stroke can be regulated from zero to twice the length of the strip, according to the position of the latter.

The transference of the crank motion to the stirrer is made by a cord and small pulleys, the weight of the stirrer being as far counterpoised as is consistent with a sufficient rate of sinking.

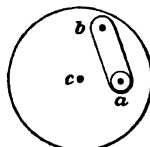

FIG. 101.

Heat Capacity of Calorimeter.—The second factor necessary for calculating a calorimetric result is the heat capacity of the calorimeter, and this is composed of the heat capacity of the apparatus itself and that of its contents.

If *c* is the specific heat of the material of which the calorimeter and stirrer are made, and *g* the weight of the parts subjected to a change of temperature, then the heat capacity of the calorimeter is *cg*, which is a magnitude to be added as a constant to the heat capacity of the contents. In most cases the separate parts of the calorimeter consist of different material, so that the sum $c_1g_1 + c_2g_2 + c_3g_3 + \dots$ has in general to be calculated instead of the simple product *cg*. The following are the most common specific heats required:—

Platinum	0.032
Silver	0.057
Nickel	0.11
Brass	0.094
Glass	0.19
Mercury	0.034

The greatest difficulty is in finding the heat capacity of the thermometer, as the weights of mercury and glass cannot be ascertained separately. Here, however, we have the fortunate circumstance that, calculated for equal volumes, the heat capacity of glass and mercury are practically the same, viz. 0.46 per cc.¹ The volume of the thermometer bulb has therefore only to be measured and multiplied by 0.46 in order to obtain the value desired. This determination

¹ For mercury $c=0.034$ and density = 13.56, whilst glass has $c=0.19$ and density = 2.4.

is made most easily by weighing a beaker with water to centigrams, suspending in it from a stand the thermometer up to the beginning of the stem, and noting the increase of weight of the beaker.

There is always some uncertainty in such determinations, from the parts of the calorimeter not all being in direct contact with the liquid; the upper rim and lid of the calorimeter, a part of the rod to which the stirrer is attached, and the upper part of the thermometer are in especial more or less incompletely affected by the change of temperature through conduction alone. The general rule to be followed is to make the doubtful parts as small as possible. If quantities of liquid over 500 g. are used, the error from this source need not be feared, and we may content ourselves with rough estimations without liability to an error of more than a thousandth of the total heat capacity.

The influence on the final result exercised by the heat capacity of the liquid is much greater, all the more because the specific heat of the various liquids is rarely known with exactness. The conditions are simplest when the calorimeter is filled with water. It is true that the high specific heat of water gives comparatively small changes of temperature for a given amount of heat, but, as the construction of very delicate thermometers is nowadays not difficult, and the errors are rather to be sought in the heat exchange of the calorimeter and its environment, this circumstance is of little importance, whilst the easy preparation of pure water and the relatively exact knowledge of the specific heat and its variation with temperature are of the greatest moment.

In many cases, especially those dealing with reactions between dilute solutions, other liquids, *e.g.* the solutions themselves, are used in the calorimeter, and the observed change of temperature must be multiplied by their specific heat. Thermo-chemists have only rarely—when they used concentrated solutions—taken the trouble to determine these specific heats, and have mostly contented themselves with approximate assumptions. Thomsen¹ assumes that the heat capacity of the solution is equal to that of the water it contains, and on this assumption a very near approach to the truth is obtained in many cases, but the error may amount to 3 per cent in solutions containing 100 mol. water to 1 mol. dissolved substance (*i.e.* about semi-normal), and may be either positive or negative. Such errors often exceed those due to the reading of the thermometer, and should be reduced as far as possible. Since for a given reaction they are inversely proportional to the dilution, they can be greatly diminished by using dilute solutions, the employment of which has the theoretical advantage of more complete electrolytic dissociation as well as the practical one that comparatively little substance is required even for large quantities of liquid. Solutions only $\frac{1}{10}$ to $\frac{1}{20}$ normal, with a

¹ *Thermochemische Untersuchungen*, vol. i., Leipzig, 1885.

thermometer divided into thousandths of a degree, still give the heat of neutralisation, for example, accurate to 0.1 %.

Berthelot estimates the heat capacity of his solutions by assuming that it is equal to the heat capacity of an equal volume of water. The degree of approximation is about the same as in Thomsen's method of calculating.

The Unit of Heat.—The customary definition of the calorie as the quantity of heat which must be communicated to a gram of water in order to raise its temperature from 0° to 1° exists exclusively in text-books of physics, and has never been practically realised. For practical purposes the calorie is rather the quantity of heat required for one degree rise at the ordinary laboratory temperature, 16° to 20°, the relation between which and the "theoretical" calorie has been for long uncertain. A very careful research by Rowland, with which a number of newer measurements are in good agreement, has shown its value in absolute measure to be

Temp.	One Calorie=	Temp.	One Calorie=
14°	41.92 × 10 ⁶ ergs.	20°	41.79 × 10 ⁶ ergs.
15	41.89 "	21	41.77 "
16	41.87 "	22	41.76 "
17	41.85 "	23	41.75 "
18	41.83 "	24	41.74 "
19	41.81 "	25	41.73 "

If the absolute system of measurement is to be carried through, calculation in calories should be given up and calculation in ergs substituted. At present, however, this has not been begun.

A recent research by Bartoli and Stracciati shows the specific heat of water to have the following values :—

SPECIFIC HEAT OF WATER

Temp.	True spec. ht. at t°.	Mean spec. ht. between 0° and t°.
0°	1.00664	...
1	1.00601	1.00632
2	1.00543	1.00602
3	1.00489	1.00573
4	1.00435	1.00545
5	1.00383	1.00518
6	1.00331	1.00491
7	1.00283	1.00465
8	1.00233	1.00439
9	1.00190	1.00414
10	1.00149	1.00389
11	1.00111	1.00366
12	1.00078	1.00343
13	1.00048	1.00321
14	1.00023	1.00301
15	1.00000	1.00282

SPECIFIC HEAT OF WATER—*Continued*

Temp.	True spec. ht. at t° .	Mean spec. ht. between 0° and t° .
16°	0·99983	1·00264
17	0·99968	1·00247
18	0·99959	1·00231
19	0·99951	1·00216
20	0·99947	1·00203
21	0·99950	1·00191
22	0·99955	1·00180
23	0·99964	1·00171
24	0·99983	1·00162
25	1·00005	1·00155
26	1·00031	1·00150
27	1·00064	1·00146
28	1·00098	1·00144
29	1·00143	1·00143
30	1·00187	1·00144
31	1·00241	1·00147

The gram calorie is too small a unit for thermo-chemical purposes, as the thermal effects are referred to the gram molecule of substances. The heat of neutralisation of hydrochloric acid with soda is, for example, 13740 cal., with a probable error of about 30 cal., so that the second last place is doubtful, and the last useless. It is, therefore, more rational to return to the original determination of the thermometric interval, and adopt as heat unit the quantity of heat which will raise 1 g. of water from the freezing to the boiling point. This rational calorie, which is approximately the centuple of both the theoretical and practical units, and is just of the right magnitude, we shall in the sequel denote by K . Unfortunately we know nothing exact as to its relation with the smaller units, so that in most cases we may take it as being 100 times the practical small calorie measured at about 18° .

All these difficulties are avoided, as has been already said, by the adoption of the absolute heat unit. The most convenient power is 10^{10} erg, which would give at 18° , $1 K = 0\cdot4183 \times 10^{10}$ erg, so that thermal effects expressed in K should be multiplied by $0\cdot4183$ to obtain them in terms of the unit 10^{10} erg.

Heat Exchange with Environment.—The chief source of error in all calorimetric measurements lies in the impossibility of preventing heat exchange between the calorimeter and surrounding objects; we can only strive to make it as small as possible and determine it numerically for each separate experiment.

The first object is attained by giving the calorimeter a highly reflecting external surface by thorough polishing in the case of metal calorimeters, so that radiation is reduced as far as possible; and by surrounding it with a vessel with a reflecting interior, polished nickel being very suitable, so that the radiated heat may be at least partially

sent back ; finally, the whole arrangement should be surrounded by a large water-bath of constant temperature to make the heat exchange take place as regularly as possible. The construction should therefore be as is indicated in Fig. 102.

The calorimeter *C* is placed in the protective cylinder *S* on cones of wood or other badly conducting material ; both are of brightly polished metal. *M* is a water jacket composed of two coaxial cylinders, whose surfaces also should be thoroughly polished, and which should contain a large quantity of water between them. *T* is the thermometer and *R* the stirrer. The other detailed arrangements of the calorimeter are not shown, as they vary greatly according to circumstances.

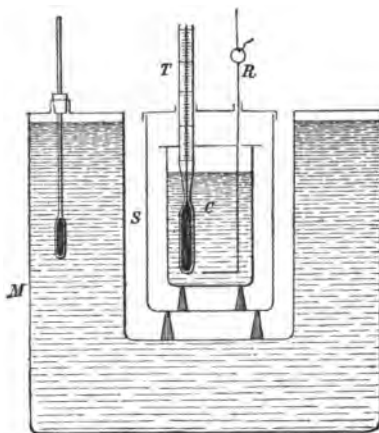

FIG. 102.

Notwithstanding all these precautions it is necessary to determine the heat exchange with the surroundings for every single calorimetric measurement. The simplest case is when the change of temperature is proportional to the time. The experiment is then regulated so that at the beginning the temperature shall be as much below the point at which the exchange is zero, as it will afterwards rise above it. The correction is then also zero, for it is composed of two equal parts of opposite sign (Rumford).

In the majority of cases the assumption made in this method is not accurate, so that a more complicated process must be adopted.

First, the thermometer of the calorimeter must be observed at regular intervals, say 20 seconds, so that the change of temperature of the calorimeter is known. This change for the small variations here dealt with proceeds proportionally to the time, so that when the warmed object is placed in the calorimeter at a definite instant, we can easily calculate the temperature at this instant, although it cannot be measured directly. The thermometer is still observed ; the temperature at first rises rapidly, reaches a maximum, from which it first descends very slowly, but afterwards with almost uniform velocity. The observations during this last period must be continued for at least as long as the time from the beginning of the experiment proper to the attainment of a uniform decrease of temperature.

We thus obtain a knowledge of the heat exchange between the calorimeter and its surroundings for the lowest temperature at the commencement, and also for a temperature very near the highest at

the end of the experiment. If we now make the assumption, as we are justified in doing for the small temperature differences here in question, that the heat exchange of the calorimeter varies proportionally to its temperature, we can calculate what the maximum temperature of the calorimeter would have been if no heat exchange had taken place at all. Suppose that each part of an experiment lasted 10 intervals, and let the temperature be distinguished by the number of the corresponding interval as index, then we have first the preliminary observation with the temperatures t_0 to t_9 ; t_{10} cannot be read directly, as at the exact moment the object is introduced into the calorimeter. As the temperature has changed by $t_0 - t_9$ in 9 intervals, we have $\frac{t_0 - t_9}{9}$ for one interval, and the temperature

$$t_{10} = t_9 + \frac{t_0 - t_9}{9}.$$

The temperatures t_{11} to t_{20} are now read off, and we assume that the temperature again changes uniformly. We observe t_{20} to t_{30} and obtain the change per interval $\frac{t_{20} - t_{30}}{10}$. To the mean temperature of the preliminary observation t_5 there corresponds therefore the change $\Delta_5 = \frac{t_0 - t_{10}}{10}$, and to the mean temperature of the final observation t_{25} , the change $\Delta_{25} = \frac{t_{20} - t_{30}}{10}$, and for every other temperature t_n the magnitude Δ_n is determined on the above assumption by the proportion

$$(\Delta_n - \Delta_5) : (t_n - t_5) = (\Delta_{25} - \Delta_5) : (t_{25} - t_5),$$

or

$$\Delta_n = (t_n - t_5) \frac{\Delta_{25} - \Delta_5}{t_{25} - t_5} + \Delta_5.$$

The mean values of the temperatures t_{10} to t_{20} are now introduced to find the corresponding losses of heat by the calorimeter, and finally the resulting expressions

$$\Delta_{10-11} = \left(\frac{t_{10} + t_{11}}{2} - t_5 \right) \frac{\Delta_{25} - \Delta_5}{t_{25} - t_5} + \Delta_5,$$

$$\Delta_{11-12} = \left(\frac{t_{11} + t_{12}}{2} - t_5 \right) \frac{\Delta_{25} - \Delta_5}{t_{25} - t_5} + \Delta_5,$$

etc., are added.

We thus get the sum of all the Δ 's

$$\Sigma \Delta = \left(t_{11} + t_{12} + \dots + t_{19} + \frac{t_{10} + t_{20}}{2} - 10t_5 \right) \frac{\Delta_{25} - \Delta_5}{t_{25} - t_5} + 10\Delta_5.$$

If we add the value $\Sigma\Delta$, which represents the sum of all the losses of temperature from the moment of immersion to the attainment of complete uniformity, to the temperature t_{20} at the moment when uniformity is reached, we obtain the corrected final temperature to which the thermometer would have risen, if there had been no loss of heat to the exterior, viz. $t_{20} + \Sigma\Delta$, which value is to be introduced into the equations as the real final temperature.

If we wish to push accuracy still further, we must consider that after the introduction of the substance the heat capacity of the whole system has increased, and that therefore the heat exchange Δ_5 determined at the beginning is too high during the actual experiment. This objection may be completely removed if the temperature at the beginning of the experiment is so regulated that no change at all takes place. When this is not done it is sufficient to replace

Δ_5 by $\Delta_5 \frac{K}{K+k}$, where K is the heat capacity of the calorimeter without the substance, and $K+k$ the capacity when the substance is added; k of course need only be known approximately.

Specific Heats.—Solid substances are heated in a special vessel (most conveniently by the vapours of boiling liquids), brought into the calorimeter, and cooled. If K is the heat capacity of the calorimeter and adjuncts, γ the specific heat to be determined, m the weight of the substance, t_a the initial, t_b the final temperature of the calorimeter (both corrected), and t_m the temperature of the heated substance, then we have $C(t_b - t_a) = \gamma m(t_m - t_b)$, and therefore

$$\gamma = \frac{C(t_b - t_a)}{m(t_m - t_b)}$$

We see that $t_b - t_a$ and $t_m - t_b$ must have the same relative accuracy. If $t_b - t_a$, for example, is 1° C. determined to 0.001° , and if t_m is 100° , whilst t_b is 20° , then t_m has only to be determined to 0.08° in order to give the same relative error.

A simple glass steam jacket of the form given in Fig. 103 is used for heating to 100° ; the steam is passed in and out through india-rubber tubes, which of course can only be used with water. The boiling vessel should be as far away from the calorimeter as possible, out of the room altogether if may be. The inner tube is closed by cotton wool during the heating, which must last at least half an hour.

If the substance has to be taken to a high temperature, a thick-walled protecting metal cylinder should be used, inside of which it is heated and brought to the calorimeter, so that its temperature does not change in the time necessary for the transference.

In many cases, *e.g.* with liquids, it is not practicable to bring the substance into direct contact with the water of the calorimeter. It

must then be enclosed in a vessel which will prevent the contact, and will conduct heat as well as possible. If the substance is in the form of solid pieces, the vessel should also contain a liquid to facilitate the conduction. The heat capacities of all this additional matter must be determined under the same conditions and with the same material as in the experiment proper.

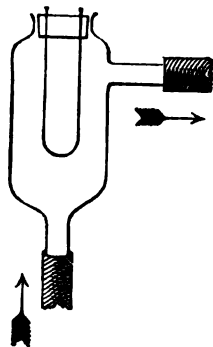

FIG. 108.

The heat capacity of liquids obtainable in quantity, such as salt solutions, can also be determined by adding a known quantity of heat to the calorimeter and determining the change of temperature which results. This heat may be supplied in various ways. We may use as "calorifer" a thermometer with a very large bulb and a stem with two marks—one at 80° say, and the other at 20° . It is warmed to above 80° and allowed to cool slowly. At the moment the mercury sinks to 80° , it is immersed in the calorimeter, and is taken out again when the second mark is reached. The quantity of heat supplied in this way is best determined by filling the calorimeter with pure water. If W is the weight of water and w the heat capacity of the calorimeter and accessories, the heat given up by the calorifer is

$$q = (W + w)(t_b - t_a),$$

t_a being the initial, and t_b the final temperature of the water, both corrected. If a weight W' of another liquid is then used, and the rise of temperature $t'_b - t'_a$ observed, the specific heat c of the substance is given by the equation

$$q = (W'c + w)(t'_b - t'_a)$$

$$c = \frac{q - w(t'_b - t'_a)}{W'(t'_b - t'_a)}.$$

The proportions of the calorimeter may be easily calculated. If a rise of temperature of 1° is aimed at, and this is quite sufficient with delicate thermometers, we require for a calorimeter of 500 cc. capacity 500 cal., which with a change of temperature of the calorifer from 80° to 20° necessitates a heat capacity of $\frac{500}{60} = 8.3$. As 1 cc. of mercury has the heat capacity 0.46, this number corresponds to a mercury bulb of 18 cc. The calorifer need not be constructed as a complete thermometer, two marks on the stem are enough. To have sufficient sensibility without excessive length of stem, the capillary is

enlarged between the marks, and the calorifer assumes the form of Fig. 104.

An instrument of this sort weighs 250 g. Instead of this relatively large weight of mercury, we may use water or any other liquid. A great diminution of weight is thus attained, but we have simultaneously the drawback of a less perfect heat conduction. To remedy this, the thermometer bulb may be made of a metal tube with a capillary attached, and of such a shape that the instrument may be used as a stirrer.

Instead of supplying definite quantities of heat by a calorifer, they may be generated in the calorimeter itself from chemical or electrical sources. The first process was used by Thomsen, who immersed a platinum flask in the liquid, and burnt a mixture of oxygen and hydrogen in its interior.¹ The method requires a somewhat large apparatus, but by a proper choice of the chemical reaction it might be considerably simplified. The electrical method, developed chiefly by Pfaundler,² is also somewhat complex in the arrangement of the apparatus.

Small quantities of liquid are enclosed in platinum flasks with a thermometer through the stopper (Marignac). Schiff makes the platinum bottle with a cross-shaped section, so that the surface, and consequently the rate of loss of heat, is increased, and uses it as stirrer. In the case of volatile liquids, care must be taken that the bottle is as full as possible, for otherwise errors would arise from the heat of condensation of the vapour.

Heat of Fusion.—The general process for ascertaining the heat of fusion is to determine first of all the specific heats, c_1 and c_2 , of the substance in the solid and liquid states respectively. It is next ascertained what quantity of heat is given up by the substance on cooling from a temperature t_a above its melting point t_0 to the temperature t_b of the calorimeter, which lies below t_0 . If this quantity is denoted by q , we have for the heat of fusion

$$\lambda = q - c_1(t_0 - t_b) - c_2(t_a - t_0).$$

The process is actually carried out by making three cooling experiments with the substance enclosed in a platinum or silver bottle provided with a thermometer, two of the experiments beginning above the melting point. If the melting point, for instance, is 50° , the substance is heated to 45° , to 55° , and to 70° or 80° . From the two last experiments the specific heat of the liquid can be ascertained, and from the first the specific heat of the solid, so that we have the

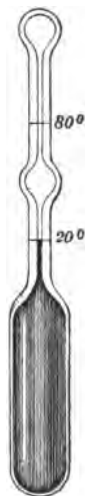

FIG. 104.

¹ *Pogg. Ann.*, **142**, 337, 1871.

² *Sitzungsber. Wien. Ak.*, **100**, April 1891.

material to calculate the heat of fusion from the second by means of the formula given above.

Occasionally the substance is liable to over-cooling. If the over-cooling reaches as low as the temperature of the calorimeter, we only need to start the solidification by introducing a trace of the solid after the temperature has been equalised, and thus obtain directly the heat of fusion, or rather of solidification, at the temperature of the calorimeter. This is, to be sure, somewhat different from the heat of fusion at the melting point, being $\Delta(c_2 - c_1)$ too low, where Δ is the difference between the melting point and the temperature of the calorimeter, c_2 the specific heat of the liquid, and c_1 the specific heat of the solid. The heat of fusion λ_0 at the melting point is therefore obtained from the heat of fusion at t° by means of the equation

$$\lambda_0 = \lambda_t + \Delta(c_2 - c_1).$$

If the over-cooling cannot be carried so low as the temperature of the calorimeter, but still somewhat below the melting point, two experiments are made, beginning in the one case with the solid, and in the other with the liquid from the same temperature. The difference between the quantities of heat given up to the calorimeter is again equal to the heat of fusion at the initial temperature, and must be corrected as above if the heat of fusion at the melting point is desired.

There are therefore both theoretical and practical advantages in allowing the over-cooling to reach only a few tenths of a degree. It is a matter of indifference at what temperature the solidification takes place during the rapid cooling of the calorimeter, provided it does so at all.

If the melting point lies below the temperature of the calorimeter, the process is carried out in a perfectly analogous manner, the substance however being cooled first of all.

Heat of Vaporisation.—The heat of vaporisation is determined by leading the vapours into a condenser immersed in the calorimeter, and determining first the heat which the vapours give up in cooling from the boiling point to the temperature of the calorimeter. If we subtract from this the heat given up by the liquefied vapour between the same temperatures, we obtain the heat of vaporisation at the boiling point.

The difficulties to be here contended with lie, on the one hand, in the vapour carrying liquid along with it, which makes the result too low, and, on the other hand, in the heat conduction through the vapour tube, which makes the result too high. Robert Schiff¹ has avoided the first error by attaching to the gently ascending tube, through which the vapour is conducted from the flask in which the

¹ *Liebig's Ann.*, 234, 338, 1886.

liquid boils, a silver trap, shown in Fig. 105, which frees the vapour from liquid carried over by it. The vapour passes from the vertical tube to the condenser in the calorimeter, whose increase of weight is equal to the weight of vapour condensed. Let q be the heat measured by the calorimeter, t_s the boiling point, t_a and t_b the initial and final temperatures of the calorimeter, then, to find the heat of vaporisation l , we have the equations

$$q = ml + mc \left(t_s - \frac{t_a - t_b}{2} \right)$$

$$l = \frac{q}{m} - c \left(t_s - \frac{t_a - t_b}{2} \right),$$

c being the specific heat of the liquid, which is determined as described on p. 127.

Besides this process there is another—a cooling method, which depends on the vaporisation of a weighed quantity of liquid in a vessel within the calorimeter. If we are dealing with a liquid boiling below the temperature of the calorimeter, we have simply to regulate the vaporisation by a tap introduced for the purpose. Liquids with boiling points up to 50° or 60° evaporate rapidly enough in an air current to be investigated in this way by enclosure in a sort of thin-walled washing bottle immersed in the calorimeter.

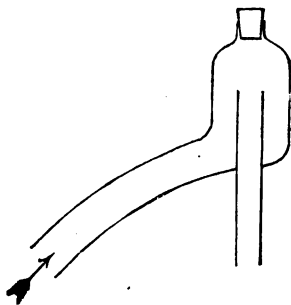

FIG. 105.

By the use of an air-pump the boiling point can be considerably lowered. The weighed flask containing the liquid is connected by a ground joint with the air-pump through a wind-chest; an arrangement for condensing the vapours either by cold or chemical means may also be inserted with advantage. To avoid the bumping which occurs readily under these conditions, it is advisable to lead a very small current of air through the liquid by means of a capillary. The apparatus is schematically represented in Fig. 106. C is the calorimeter in which the flask with the capillary k is immersed; the air-pump is attached at l . Attention must be paid to having the vapour tube about 1 cm. wide, or else the vaporisation will proceed very slowly.

The heat of vaporisation below the ordinary boiling point is obtained by these methods. It is calculated for the mean temperature of the calorimeter, and Rumford's artifice (p. 125) may be used with advantage. The heat of vaporisation is a function of the temperature, decreasing almost proportionally to its rise, so that

$l_t = l_0 - kt$, where k is a constant depending on the nature of the liquid, l_0 and l_t being the heats of vaporisation at 0° and t° respectively.

Heat of Solution.—Liquid and solid substances, the latter in the

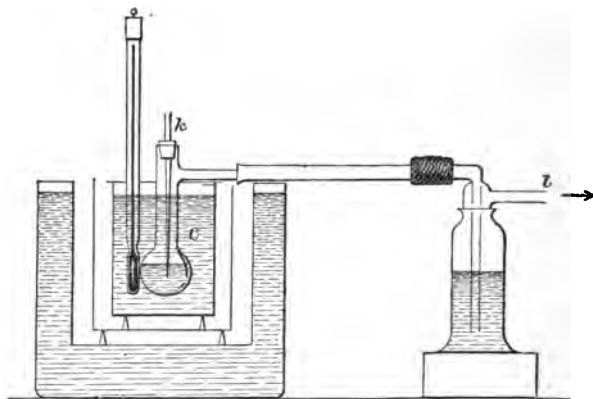

FIG. 106.

state of very fine powder, are heated to the temperature of the calorimeter and then dissolved in the water it contains. This is best done by sealing up the substances in weighed thin-walled bulbs or cylinders, sinking these in the calorimeter, and crushing them after equalisation of temperature, so that their contents are dissolved. This process cannot be adopted in some cases where the reaction is very violent, but even then several bulbs containing small quantities may often be used. If this will not do, recourse must be had to some other method of attaining a slow and adjustable rate of interaction between the substance and the water. The method is not applicable when we are dealing with salts, like anhydrous sodium or magnesium sulphate, which form hard cakes under such circumstances, and afterwards dissolve very slowly. Such salts are introduced from a weighing bottle provided with a coarse sieve like a pepper-box, by dusting them in in a finely divided state, so that caking is entirely prevented.

Gases are led directly into the water of the calorimeter, the size of the bubbles, *i.e.* the intimacy of contact with the water, being regulated according to the greater or less solubility. The determination of the quantity dissolved is always made by analysis of the contents of the calorimeter, so that it is of little importance if some gas escapes undissolved, for the only error caused by this is the carrying off of a corresponding quantity of water vapour, whose latent heat is lost by the calorimeter, and this error, as may be seen from a rough calculation, is usually vanishingly small.

Calorimeters with Separate Chamber.—Chemical processes

which must be executed out of contact with the water of the calorimeter, are made to take place in a separate chamber, which is sunk in the water, and may be constructed of glass, platinum, or other material, according to circumstances. For a great many purposes a wide test-tube passing through the lid of the calorimeter may be used. The substances enclosed in glass bulbs, or otherwise kept from reacting, are placed in the chamber; after equalisation of temperature the reaction is brought about by crushing the bulbs, or in some corresponding way, and the heat generated is transferred to the water of the calorimeter as quickly as possible by rapid stirring. If gases are evolved, the reaction chamber must be closed, and connected by a side tube with a worm immersed in the water of the calorimeter, through which the gases then pass.

Reactions in Dilute Solutions.—A great number of processes, in especial the very important ones connected with salt formation, take place even in very dilute solutions so rapidly that they are amenable to calorimetric measurement. The apparatus for such experiments receives a special form on account of the liquids to be mixed having approximately the same volume. The method, adopted by the early investigators, of having one of the liquids in a thin-walled beaker or flask, which was immersed in the other liquid contained in the calorimeter, and assuming that after some time the two liquids would have the same temperature, is not adapted for accurate measurements. A special determination of the temperature of each portion is necessary.

The most suitable apparatus is Julius Thomsen's, which consists of a vessel with a valve in the bottom, and so adjusted on the top of the calorimeter that the contents flow into it when the valve is opened. I find it practical to have this vessel made of glass, for its heat capacity in this case goes for nothing, and it is not only cheaper, but of more general and of more convenient application on account of its transparency. The apparatus is schematically represented in Fig. 107. Below there is the calorimeter, with the thermometer T and stirrer R ; above there is the glass vessel, also provided with a thermometer t and stirrer r , as well as with the valve worked by the glass rod v . The upper vessel is of course also protected from loss of heat by metal cylinders not shown in the figure.

The essential thing with this arrangement is the use of two thermometers, which are both read during the first part of the experiment. They must therefore be made thoroughly comparable by immersing in a large water-bath, and carefully reading the corresponding points as the temperature rises. According to Thomsen, it is best to ascertain if the reduction is correct by filling both upper and lower vessels with water, and finding if the thermal effect calculated by the formula given below is *nil*. If it is not, the deviation gives the error of the arrangement.

The thermal effect q in the calorimeter is calculated as follows:—
If A is the heat capacity¹ of the upper, B of the lower liquid, t_a and t_b the corresponding temperatures, t the final temperature (all of these corrected), and b the heat capacity of the calorimeter with accessories, then

$$q = A(t - t_a) + (B + b)(t - t_b),$$

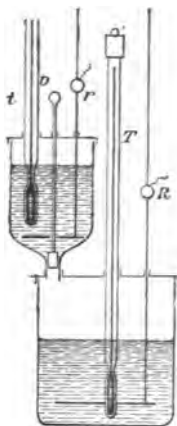

FIG. 107.

it being assumed that the heat capacity of the product of the reaction is equal to the sum of the heat capacities A and B of the two solutions before the reaction. Instead of A and B it is customary to take the heat capacities of the water in the solutions (p. 122), or the weights which are numerically equal to them, and this is the more correct the more dilute the solutions are.

It is not to be overlooked that a source of error lies in the use of two thermometers, and the development of a method in which the temperature of the two liquids before the experiment would be made exactly equal, as tested by a suitable instrument more sensitive than the ordinary thermometer, *e.g.* a thermo-element or a Leslie's differential thermometer, would be a great advance if the apparatus could be made sufficiently simple.

Heat of Combustion.—The best method for determining heats of combustion is that introduced by Berthelot, who burns the substance in a closed vessel containing oxygen compressed to 25 atmospheres. The process for a long time was very much restricted, practically on account of the expense of the "calorimetric bomb" lined with platinum; but now that Mahler has substituted enamel for platinum, the apparatus may be had for £20 to £25,² and is capable of general application.

The oxygen is compressed in steel cylinders to 100 atmospheres. Two cylinders should be connected with a T-tube, so that when the pressure in one has fallen below 25 atm., the filling is begun with it, and then brought up to the proper pressure by the other (Stohmann).

If the substance to be burnt is solid, it is compressed into pastilles by means of a small press, such as are used by druggists. Liquids are enclosed in small collodion balloons.

Berthelot's bomb and Mahler's "grenade" both contain a platinum cup, for the substance, fastened to the lid by a stout support of the

¹ By heat capacity the product of the specific heat and the weight of the substance is always understood, or, in a composite system, the sum of all such products.

² From Golaz, Paris.

same metal. A second platinum rod passes through the lid to the neighbourhood of the cup, and is electrically insulated from it. Between the two there is fastened a very fine iron wire, which is brought to incandescence by an electric current and ignites the substance. Through the lid there also passes by means of a stuffing box a screw bored out axially, with a conical valve at the end. This is used for letting the gases in and out.

To perform an experiment, the weighed substance is placed in the cup, the iron wire is fastened in position, and the lid screwed on airtight by means of a lead washer to the body, which contains a little water. The screw valve is unscrewed, and connected with the oxygen cylinder, oxygen being then admitted until the manometer indicates 25 atm. The "grenade" is next closed by screwing the valve tight, and immersed in the calorimeter. After equalisation of temperature and the necessary observations on the fall of the thermometer, the lid and the insulated platinum wire are connected with the two poles of a small battery; the iron wire glows, burns, and the falling drops of white-hot oxide ignite the substance.

The calculation is made as usual. The great mass of the bomb, which consists of different materials, necessitates a very careful measurement of its water equivalent. This can be done empirically by making two combustions of the same substance with different quantities of water in the calorimeter. If the weights of substance are m_1 and m_2 , Δ_1 and Δ_2 the corresponding rises of temperature, then we have the equations—

$$\frac{q_1}{m_1} = \Delta_1(K + k_1), \quad \frac{q_2}{m_2} = \Delta_2(K + k_2),$$

where q_1 and q_2 are the amounts of heat developed, K the heat capacity of the bomb, and k_1 and k_2 the two quantities of water in the calorimeter. Since the same substance was used in both cases,

$\frac{q_1}{m_1} = \frac{q_2}{m_2}$, so that $\Delta_1(K + k_1) = \Delta_2(K + k_2)$, and

$$K = \frac{k_2\Delta_2 - k_1\Delta_1}{\Delta_1 - \Delta_2}.$$

As this is a differential estimation, the conditions for accuracy are not very favourable, and the experiment has to be repeated several times.

The heat capacity of the bomb can also be determined by burning a substance of known heat of combustion, *e.g.* naphthalene = 9693 cal. per gram, and calculating K from $\frac{v}{m} = \Delta(K + k)$, for $\frac{v}{m}$ is equal to 9693, and both Δ and k are given by the observation.

Besides the ordinary correction for heat exchange with surround-

ing objects, the heat of combustion of the iron wire, 1572 cal. per gram, must be subtracted. Some nitric acid is also formed from the nitrogen always contained in the oxygen. The heat of formation of nitric acid is 14900 cal. per gram molecule in dilute solution; the amount produced is estimated by titration with decinormal alkali.

The papers of Berthelot and his pupils must be consulted for information concerning the combustion of substances containing sulphur,¹ chlorine, bromine, and iodine.²

The Ice Calorimeter.—The ice calorimeter devised by Bunsen is a very suitable instrument for some purposes, and possesses the advantage of making very small quantities of heat accessible to measurement, but at the same time it has the drawback of being troublesome to prepare and to work. Its accuracy is often overestimated; the relative error is approximately equal to that of the mixing calorimeter, normal conditions for both being assumed. The essential advantage of the ice calorimeter is its independence of time; since it is used at a constant temperature, the heat exchange with neighbouring bodies may be reduced to zero, so that we are in a position to measure very slow thermal effects with almost the same degree of accuracy as instantaneous ones.

The ice calorimeter consists of two glass cylinders, one inside the other (Fig. 108), the intermediate space being filled with water and mercury. The water is first boiled in a beaker, a little being simultaneously boiled in the annular space of the calorimeter; after some time the side tube of the calorimeter is dipped into the boiling water in the beaker and the flame under the calorimeter removed; the water then enters quite free of air. When the calorimeter is filled, a small bubble of vapour always remains; this bubble is allowed to ascend the narrow tube, and mercury is poured in while the calorimeter is held upright. During the cooling, the side tube must always be kept filled with mercury. Finally, by inclining the calorimeter, water is allowed to pass into the side tube, and is replaced by mercury until the volume of the latter is at least $\frac{1}{10}$ of the volume of the water.

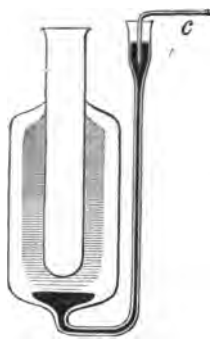

FIG. 108.

The calorimeter is now placed in ice, and after it has cooled nearly to 0° , a freezing mixture of ice and alcohol is put into the inner cylinder, and renewed from time to time until a cylinder of ice almost reaching to the outer wall of the calorimeter surrounds it. During the freezing a large part of the mercury is again expelled.

Meanwhile a glass or porcelain vessel, of such a size that the calorimeter may be sunk in it nearly to the top of the inner tube, is

¹ *Ann. de chim. et de phys.*, **22**, 173, 1891.

² *Ibid.*, **23**, 507, 1891.

filled with distilled water and pure ice, and fixed upright in a large vessel (a wooden pail), so that it is surrounded on all sides by ice. The calorimeter when ready is fastened into an overlapping lid which fits the inner vessel, and is sunk into the latter, the whole being then completely packed round by ice in the pail. Before this the freezing mixture is removed from the inner tube, which is then filled to about one quarter with water.

As Bunsen's calorimeter depends on the measurement of the change of volume caused by the melting of the ice, an arrangement must be attached for determining this. Bunsen uses a divided capillary tube bent at right angles, which is fixed into the side tube by means of a soft cork, the longer divided limb lying horizontal. The cork is pressed in until the mercury nearly reaches the end of the capillary, for, as the ice melts, there is contraction of volume and the mercury moves backwards.

The original arrangement is in many ways defective, and the following one has been substituted for it by Schüller and Wartha:—A stout-walled tube of about 1 mm. bore is uniformly melted together at one end, blown out somewhat, and then carefully ground down until a small clean-edged opening has been made (Fig. 109, *b*).

The tube is then bent twice and fastened into the calorimeter. Under the opening there is a weighed porcelain dish containing mercury. The determination consists in the quantity of mercury sucked in during an experiment being weighed, not measured, whereby the capillary frictional resistance in the tube, which may

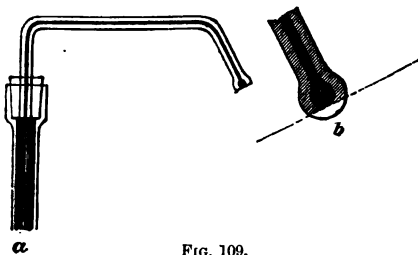

FIG. 109.

cause considerable errors, is entirely avoided. At each removal of the mercury dish, another must be slipped under the tube in its place in order to prevent the entrance of air.

If we wish to retain the convenience of being able to observe directly the course of the process, we may fill the capillary with coloured petroleum, or any other suitable liquid, instead of mercury. The arrangement of Fig. 110 is then employed. By opening the tap the petroleum may be made to rise at any time to the upper end of the scale tube *rr*, which must be inclined upwards in order that the liquid may give a good reading. The advantages of both methods may be united by having a branch at *a*, to which a tube like that in Fig. 109 may be fitted by means of a ground joint; a three-way tap at the junction allows the two arrangements to be used separately.

The calorimeter should not be used immediately after being prepared, for at first there is a considerable motion of the thread in

consequence of incomplete equalisation of temperature. After two or three days this motion, although it does not altogether cease,

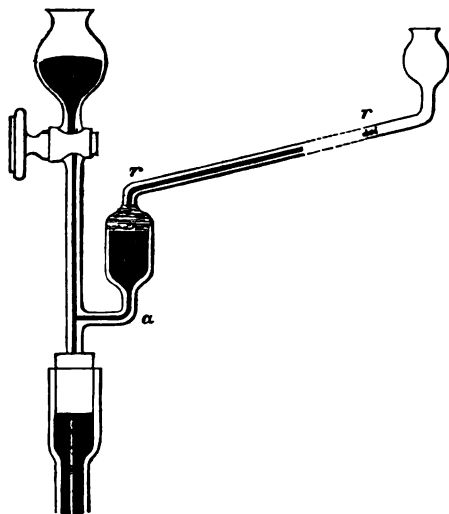

FIG. 110.

becomes regular. The most favourable case is when a slow increase of volume takes place, corresponding to fusion of ice in the calorimeter. By careful addition of very small quantities of a salt to the ice-water which surrounds the calorimeter, the external temperature may be made to sink until the motion of the thread practically vanishes. This regulation can be effected in another way by making the measuring portion movable up or down by means of an intermediate piece bent twice at right angles, and two ground joints permitting rotation. As the melt-

ing point of ice sinks with increase, and rises with diminution of pressure, it is possible in this way to equalise the melting point in the calorimeter with the temperature surrounding it.

The calculation of the heat supplied to the calorimeter is simplest when the mercury drawn in is weighed: 1 cal. equals 0.01544 g. mercury, or $1 K = 1.544$ g. If a divided capillary is used, the calorie is determined empirically by warming a known quantity of water sealed up in a thin-walled tube to a known temperature, and allowing it to cool in the calorimeter.

The calorimeter indicates very slowly, so that each experiment occupies one or two hours, and in certain circumstances even longer. In any case we must wait until the calorimeter shows itself to be again in a completely stationary state, before the final reading is taken.

CHAPTER XI

OPTICAL MEASUREMENTS

Refraction Coefficients.—The coefficient of refraction is the ratio between the velocity of light in vacuo and in the substance under investigation. In practice the refraction coefficient is always determined with respect to atmospheric air, and is therefore to be multiplied by 1.00029, the refractive index of air with respect to a vacuum, in order to reduce it to the absolute value. In the cases which interest us this correction is not in general applied, as its influence on the relations to be ascertained practically vanishes.

Various methods are employed for determining refractive coefficients, but of these we need only consider the method of deflection and the method of total reflection. For the first method the spectrometers of Meyerstein and Abbe are used, for the second the refractometers of Abbe and Pulfrich.

Meyerstein's spectrometer consists of a divided circle on which two telescopes have independent motion, and round whose axis an adjustable table carrying the prism also rotates. The following operations are necessary to adjust the spectrometer:—

The observing telescope is removed from its support and directed towards the window, the ocular lens being adjusted with reference to the cross threads until they become distinctly defined. It is then pointed at a sharply defined very distant object, and is so adjusted by moving the ocular tube that the image and cross threads suffer no mutual displacement when the eye is moved to and fro in front of the eye-piece.

The telescope is then placed in position and brought into line with the collimator, the slit of the latter being illuminated. The tube carrying the slit is moved out or in until the image is perfectly sharp as seen through the telescope, and is not displaced with regard to the cross wires when the eye is moved. Both telescopes are thus sighted for infinity.

The observing telescope is now provided with a Gauss eye-piece, usually an adjunct of the spectrometer. This is cut open laterally

between the eye-piece and cross wires, the space thus formed containing a plane glass plate inclined at 45° to the axis of the tube. The eye-piece is adjusted to infinity by obtaining a sharp image of the slit. A plane glass plate is now placed vertically on the table, and the mirror image of the cross threads is found, the eye-piece being illuminated from the side. If the adjustment to infinity is good, the image of the cross wires appears sharp, but it will seem raised or lowered with respect to the cross wires themselves. The table is then turned through 180° , and the new position of the image observed. If it coincides with the previous position, the plate is parallel to the axis of rotation; if not, its position must be altered until it does so. Then by means of the screw below the telescope, the cross wires are brought into coincidence with their mirror image. To be perfectly certain of the adjustment, the operation should be repeated, and any slight errors corrected. In this way the observing telescope is set at right angles to the axis of rotation. A fine hair is now stretched across the middle of the slit, and the collimator moved in a vertical plane until the hair appears exactly at the centre of the cross wires of the telescope when it is directed towards the slit.

The prism is now placed on the table, and its refracting angle brought into parallelism with the axis of rotation. This is attained when the mirror image of the slit with the horizontal mark appears in its proper position at the cross wires for both surfaces of the prism. The telescope is set at an angle of 90° to 120° with the collimator, and the prism placed so that one of its faces is parallel to the line joining two of the levelling screws of the table, and the image of the slit is reflected into the telescope. By means of these screws the horizontal thread of the slit is adjusted to the centre of the cross wires. The table is then turned till the second prism face reflects the slit into the telescope, and the third screw is moved till the thread is again brought into position on the cross wires. These adjustments also are repeated. The prism is then properly set. In the case of liquids, where the same hollow prism is repeatedly used, some arrangement should be made for always placing the prism in the same way on the table, in order to avoid repeating the adjustment. This may be effected by having small abutments on the table, or merely engraved lines.

The measurement of the refracting angle ω , and the deviation δ , has next to be made. The refracting angle is determined by setting collimator and telescope at an angle of 100° to 120° , and turning the table with the divided circle until the mirror image of the slit appears at the cross wires reflected first in one face and then in the other. The angle found is $180^\circ - \omega$. If the prism cannot be turned, its refracting edge is directed towards the collimator, and the two images of the slit are found by moving the telescope. The rotation of the telescope is then double the refracting angle.

The deviation δ is measured by observing the image of the slit through the prism and turning the prism slightly in both directions. In one direction the image will approach the line of incidence. The rotation is continued in the same direction until the image begins to move back. It is now easy to find the position of least deviation by slight rotatory movements. The position of the image of the slit is not very sensitive to small rotations of the prism. The deviation δ is the angle through which the telescope has been turned from the zero position, which is tested, and, if necessary, corrected by direct adjustment of the telescope to the slit without the intervention of the prism. The index of refraction is then

$$n = \frac{\sin \frac{1}{2}(\omega + \delta)}{\sin \frac{1}{2}\omega}.$$

A hollow prism is used for the investigation of liquids, the walls being formed of plane glass plates, which can usually be taken apart to facilitate cleaning. In this case the refracting angle must be determined. I have found it much more convenient, however, to save this redetermination by cementing the plates together. For alcoholic and similar liquids isinglass may be used, and for aqueous liquids very thick asphalt varnish, applied after heating. The refractive coefficient of liquids is largely dependent on the temperature. A small thermometer is therefore fixed in the opening of the prism, the whole is warmed somewhat above the temperature at which the measurement is to be made, and the reading taken at the moment the slowly falling thermometer passes through the proper point. It is still better to begin the observations somewhat earlier, and to continue them below the point in order to be able to interpolate for the value desired.

The liquid must be carefully removed after the experiment. If a large stock is at hand, *e.g.* salt solutions, the prism should be rinsed out once or twice with the new solution, after the previous one has been removed by a pipette. With small quantities of liquid the prism should be washed out twice with ether, and dried by an air current before the new liquid is introduced.

Abbe's spectrometer is simpler than Meyerstein's, having only one tube, which is made to serve both as collimator and observing telescope. To effect this purpose the telescope is provided with a slit in the focal plane of its objective, and this slit is covered by a right-angled prism. The light incident from the outside goes through the prism, is reflected from its farther surface, and returns to the telescope, in which the image of the slit is brought into coincidence with a thread. The reflecting surface is then at right angles to the incident ray, which returns into itself, and the path is such as would correspond to the minimum deviation in a prism of double the refracting angle (Fig.

111). Prisms of 20° - 30° must therefore be used, and there is the advantage of not having first to seek for the position of minimum deviation, as the path of the ray is necessarily the right one if the image of the slit is on the cross wires.

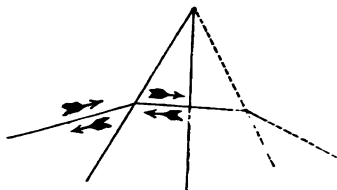

FIG. 111.

The adjustment of the prism is very simple. After the telescope has been set at right angles to the axis of rotation as usual, the prism is cemented on to a ring fastened vertically on the table of the apparatus,

and rotating in its plane. One face is nearly right to begin with, and can easily be corrected by a levelling screw. The second face is then adjusted by simply rotating the ring in its plane.

If the prisms are too heavy for this mode of attachment, which is very often the case with prisms for liquids, they are set on a table with three levelling screws.

The back face of the prism may be made to reflect better by covering it with tin-foil, over which a few drops of mercury have been rubbed.

The Abbe spectrometer, made by Zeiss of Jena (price £40), gives an accuracy of a few seconds, and the dispersion can be determined even more closely.

The calculation of the index of refraction is made by the formula

$$n = \frac{\sin(\omega + \delta)}{\sin \omega},$$

which is at once obtained from the previous formula by a consideration of Fig. 111.

Pulfrich's Refractometer.—The instrument best suited to the requirements of the physical chemist who wishes to measure the refractive indices of liquids is Pulfrich's "refractometer for chemists."¹ It consists of a right-angled prism of very highly refracting glass, and a telescope movable on a divided circle. The incident ray enters almost parallel to the upper horizontal face, on which a small cylinder to contain the liquid is cemented. If we look with the telescope through the other face, only such rays will pass from the liquid to the prism as have their angle of emergence smaller than the angle of total reflection, and this we find by moving the telescope to the point where there is the change from light to dark.

The calculation of the index of refraction is performed as follows :—Let *ac* (Fig. 112) be the last ray which can pass from the liquid on the upper side of the prism into the prism; then the sine of the

¹ To be had from M. Wolz, Bonn, for about £10.

angle r must be equal to the ratio $\frac{N}{n}$ of the indices of refraction, n being that of the liquid, and N that of the prism. Thus we have $\sin r = \frac{n}{N}$. On the other hand, for the emergence of the ray from the

prism into the air we have $\frac{\sin e}{\sin i} = N$. But since the prism is right-angled, $\sin r = \cos i$, and $n = N \cos i = N \sqrt{1 - \sin^2 i}$, and if we substitute for i the directly measured angle e by means of the equation $\sin i = \frac{\sin e}{N}$, we then obtain $n = \sqrt{N^2 - \sin^2 e}$ as the expression for the

index of refraction. To facilitate the use of the apparatus, a table of the function $\sqrt{N^2 - \sin^2 e}$ for all necessary values of e is given along with it, N being determined for the glass used in the prism and for sodium light.

If the cylinder, as frequently happens, breaks loose from the prism and has to be cemented on again, great care must be taken that, at the spot where the light enters, the edge of the upper circular plane surface is entirely free from cement, as the sharp definition of the limiting line sought for, depends on the cleanness of this edge. The cylinder during the observation is closed with a stopper carrying a thermometer. The temperature is taken into account as described on p. 141. The instrument is accurate to about 5 units of the fifth decimal place, and might be made still more so by the use of a finer division of the circle, as the adjustment is more exact than corresponds to the actual smallest reading of 1'.

Pulfrich's refractometer can also be used for the determination of the refractive coefficients of solid substances when they are isotropic, as well as for the measurement of the ordinary coefficient of uniaxial substances. The determination need not be made with large pieces, as the powdered material is all that is required.¹ The process is carried out by filling the cylinder with a mixture of two liquids of very different refractive coefficients (acetone and bromonaphthalene) in such proportions that the index of refraction is nearly that of the solid, which is then introduced in the form of powder. The limit appears in general quite indistinct in the telescope; but if the index

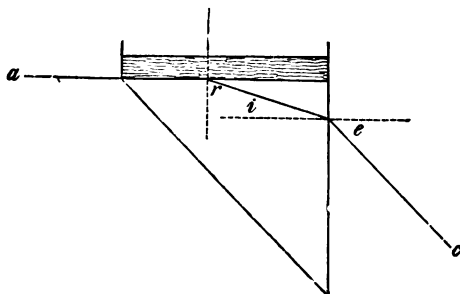

FIG. 112.

¹ Le Blanc, *Zeit. physikal. Chem.*, 10, 433, 1892.

of the liquid is greater than that of the solid, a bright band appears in addition at the boundary between light and dark, whereas if the index of the liquid is smaller, the boundary is simply indistinct. One or other liquid is then added until the boundary is quite sharp. The coefficient of refraction calculated from the angle read off is that of the solid as well as of the liquid. The determination can be made accurately to a few units in the fifth decimal place.

The phenomena with uniaxial crystals are similar, but the passage from light and dark is less sharply defined.

If the Pulfrich refractometer is to be used for higher temperatures, both cylinder and prism are enclosed in a heating arrangement. The detailed description of such an apparatus is given by Brühl in *Berichte*, **24**, 286 (1891).

Abbe's Refractometer.—This apparatus also is based on total reflection, which takes place at a thin film of liquid enclosed between two prisms of high refractive power. To use the instrument, one of the prisms is removed and the exposed surface of the other brought into the horizontal plane. A drop of liquid is then placed on it and covered by the second prism. The prisms and telescope are now rotated until the light reflected from the illuminating mirror falls approximately along the optical axis of the telescope. The adjustment is made to the boundary between light and dark. Dispersion can be removed by a compensator in the larger instruments, and may be approximately measured. The index of refraction is read directly from the scale.

A great advantage of the instrument¹ is that it requires very little liquid. The scale gives the third decimal directly, and the fourth can be estimated to two units; the accuracy is thus less than in Pulfrich's instrument. There is also the disadvantage that the temperature of the liquid is not known. A heating arrangement has recently been constructed to obviate this difficulty, a definite temperature being maintained by means of a water jacket.

Differential Refractometer.—In the study of solutions it is much more important to measure exactly the relatively small differences between the refractive coefficients of the solution and the solvent, than to ascertain the absolute value of the coefficients themselves. In 1886 (*Lehrbuch der allgemeinen Chemie*, ii. 767) I showed that this object could be best attained by the opposition of two hollow prisms, one containing the solution and the other the solvent; the deflections are then for the most part compensated, and only the difference of the refractive indices appears. The temperature too in this case has only an influence of the second order, as any change affects both parts simultaneously. This idea has been very happily carried into effect by Zeiss of Jena, who now makes a differential refractometer,²

¹ Price £13 from Zeiss, Jena, or £15, with heating arrangement.

² Price £12.

having two such pairs of prisms. The observation is made by auto-collimation on an ocular scale and is accurate to a few units of the fifth decimal place.

A drawback of the instrument in its present form is that the liquid comes in contact with brass—a circumstance which excludes the investigation of many solutions. By constructing the corresponding parts of glass, or of ebonite if need be, this defect might be remedied. On the whole, however, it admits of extremely convenient observation.

Light of Definite Wave-length.—The sodium flame is most usually employed as the source of monochromatic light. When a moderately bright light is needed, a Bunsen burner in which common salt is vaporised suffices. Before being used the salt must be heated red-hot, or else it will sputter on account of some mother-liquor being enclosed. It is put into a small platinum wire basket, which is brought into the lower front edge of the flame. The burner is usually surrounded by a sheet-iron chimney with an opening where the flame is brightest. An adjunct which is very convenient but usually omitted, is a small accessory flame which permits the chief flame to be extinguished between the observations, and rekindled by simply turning the tap immediately before use. Gas is not only saved in this way, but the very unpleasant effects of sodium chloride in the air are to a great extent avoided. If the flame is to be used for any length of time it is best to have it in a draught chamber.

When a very bright light is needed, we may adopt Fleischl's proposal and use the more volatile sodium bromide instead of sodium chloride, but this must always be done in a draught chamber on account of the bromide vapours. The hydroxide is another volatile sodium compound which may be used. For still brighter lights Du Bois¹ employs the oxyhydrogen flame playing on rods 0·4 cm. in diameter and made of sodium bicarbonate, sodium bromide, and gum tragacanth. They vaporise pretty rapidly, 1·2 cm. per minute, so that some adjusting arrangement must be used to push them forward regularly.

Red and green lights of one wave-length are obtained in the same way with lithium and thallium salts respectively. The latter are poisonous, and must therefore always be used in a good draught.

The spectrum of hydrogen at low pressures under the influence of the electric discharge gives good red and green lines; the third violet line is often very weak. It is most convenient to employ tubes which can be used lengthwise (not crosswise as usual), as they give a much brighter light.

The wave-lengths of these various lines in millionths of a millimetre are

¹ *Zeitschr. für Instr.*, 12, 165, 1891.

Li	670·6
H (red)	656·2
Na	589·5 and 588·9
Tl	534·5
H (green)	486·0
H (violet)	434·0

Constants of Refraction.—Two formulæ are used to express the relation of the refractive coefficients to the chemical nature of the substances investigated. These formulæ are

$$R_1 = (n - 1)\phi, \quad R_2 = \frac{n^2 - 1}{n^2 + 2}\phi,$$

ϕ being the molecular volume, *i.e.* the molecular weight divided by the density. The first expression was given by Gladstone and Dale, and by Landolt; the second by Lorenz and Lorentz. Both magnitudes are to some extent dependent on the temperature; they are often called the molecular refractions.

For mixtures we have approximately

$$(n_1 - 1)v_1 + (n_2 - 1)v_2 + \dots = (N - 1)V,$$

and

$$\frac{n_1^2 - 1}{n_1^2 + 2}v_1 + \frac{n_2^2 - 1}{n_2^2 + 2}v_2 + \dots = \frac{N^2 - 1}{N^2 + 2}V,$$

where $v_1, v_2 \dots$ and $n_1, n_2 \dots$ are the volumes and refractive coefficients of the components, and N and V the corresponding values of the mixture.

For chemical compounds also we have frequently a similar formula

$$m_1r_1 + m_2r_2 + m_3r_3 + \dots = R,$$

where $r_1, r_2 \dots$ are the atomic refractions formed analogously to the molecular refractions. The molecular refractions, however, depend to some extent on the constitution, the influence of which may be taken into account by the use of additive terms. The following values of the atomic refractions are given by Conrady for sodium light and the R_2 formula:—

Carbon uncombined	2·592
Carbon, combined	2·501
Hydrogen	1·051
Hydroxyl oxygen	1·521
Ether oxygen	1·683
Carbonyl oxygen	2·287

Double linking of carbon atoms	1·707
Chlorine	5·998
Bromine	8·927
Iodine	14·12

For dissolved substances we can calculate approximately a molecular refraction with the formula for mixtures. It is most convenient to express the composition of the solution investigated in the molecular form $A + nL$ (*e.g.* $\text{NaCl} + 8\cdot3\text{H}_2\text{O}$), where A denotes the dissolved substance and L the solvent. The density is determined and divided into the molecular weight of the solution, whereby the molecular volume ϕ is ascertained, with which we can calculate R for the solution. If we subtract from this n times the molecular refraction of the solvent, which is determined from separate measurements, we obtain as residue the molecular refraction of the dissolved substance.

The method leads to tolerably correct numbers for non-electrolytes; electrolytes exhibit large and regular deviations.

Spectrum Observations.—Approximate determinations of wave-lengths in the spectrum are made with Bunsen and Kirchhoff's spectroscope, which consists of a collimator with a slit in its principal focus, a telescope adjusted to infinity, and a prism. These three parts are so arranged that the middle of the spectrum, *i.e.* yellow to green, corresponds to the minimum of deviation. There is usually also a third small telescope which has a scale in its focus, and is so placed that a mirror image of the scale in the face of the prism next the observing telescope is visible in it. An easily identified line, *e.g.* the sodium line, is made to coincide with a definite division of the scale, and with reference to this line the position of all other lines is read off.

To reduce the readings to wave-lengths, the position of the lines given on p. 146 is found on the scale; the scale-divisions are then tabulated as abscissæ on co-ordinate paper, and the wave-lengths (minus 400, to save space) as ordinates. The continuous curve formed by joining up the points thus obtained gives the wave-lengths for all intermediate divisions.

If the greatest possible accuracy is desired, a solar spectrum is generated alongside the spectrum under investigation by means of a reflecting prism placed in front of the slit, and the position of the line to be measured with respect to the nearest solar line is determined with an ocular micrometer, the wave-length being then interpolated from a table of the solar spectrum.

Such measurements are scarcely needed for our purpose, as spectroscopic phenomena are just beginning to pass from the descriptive to the rational stage.

Sharp bright lines are given almost exclusively by incandescent gases and vapours; and sharp absorption lines also are nearly all due

to gaseous bodies. Liquids and dissolved substances give almost without exception broad absorption bands whose breadth depends on the optical thickness (*i.e.* concentration multiplied by thickness of layer), and whose position therefore can only be determined approximately. In such cases it is necessary to give the concentration and thickness of the layer observed, in order sufficiently to define the observations.

Photographs of absorption spectra are often valuable, as they render possible a general comparison of the character of several spectra, and give a convenient indication of their likeness or unlikeness. I take the following account of the technique of the process from a research I have lately published (*Zeit. physikal. Chem.*, **9**, 579, 1892):—

The production of photographs as nearly as possible comparable with each other was carried out as follows:—On the objective board of a box camera there was screwed a small horizontal board which carried the prism and the slit (with collecting lens) taken from a spectrometer. The spectrum was thrown on the ground glass of the camera by means of the back lens of a rectilinear combination by Suter with a focal distance of 40 cm., and was then carefully adjusted by comparison with the solar spectrum. The prism was a hollow one with a refracting angle of 60° , and was filled with monobromnaphthalene,¹ the spectrum being considerably extended in the ultra-violet.

To obtain the spectra in perfectly corresponding positions, there was fastened vertically to the back frame of the camera a board, which, by means of screwed-on guides, permitted the plate box to be moved vertically. In this board there was a horizontal slit 1 cm. wide and 8 cm. long, which cut down the spectrum to the desired size. The plate box, of the usual form for 9×12 cm. plates, had a brass guide plate screwed on the side with ten holes in it about 1 cm. apart. By means of a screw with a conical point which passed through one of the vertical guides, and could be inserted into each hole in succession, it was possible to place the plate box in the necessary positions, distant 1 cm. from each other, with sufficient exactness. To be quite sure of the usefulness of this arrangement, I in many cases stretched a thread across the slit at the position of the *D* line, as shown by a sodium flame. This artificial *D* line appears as a fine dark line in the photographs, and makes the comparison of the spectra a very sharp one. The exactness of its position was often tested.

After rejecting the zircon and lime light as illuminants on account of the great variations in their intensity, I finally adopted exclusively the Welsbach incandescent gas-burner. As the time of exposure with a sufficiently narrow slit amounted to 3-5 minutes, and as ten

¹ B. Walter, *Wiedemann's Annalen*, **42**, 511, 1891.

spectra with the same exposure had to be photographed on the same plate, the exact timing was rather troublesome until I simplified it in the following way:—

The hour hand of an ordinary pendulum clock was removed, and the minute hand was provided with a platinum wire, another being fastened to the dial. The current from an electric battery and bell was led on the one hand to a spring contact which rested on the arbor of the minute hand, and on the other to the fixed platinum wire, so that the bell rang when the minute hand touched this wire. As the hand was each time set back the necessary number of minutes from the fixed contact, the bell sounded after the proper interval had elapsed, and thus saved attention being paid to the time in the meanwhile. The exact determination of the time was made by means of a chronoscope with a large second hand, the clock giving its warning 15 to 20 seconds before the real time to be observed.

The photographs were mostly taken with the eosine-silver plates by Perutz of Munich, which are very sensitive in the yellow, and answered extremely well; ordinary bromide of silver plates by Monckhoven were also used occasionally for spectra in the blue and violet. The plates were developed with a mixed eikonogen-hydroquinone developer. The time of exposure was mostly three minutes with Perutz plates, and five with Monckhoven plates.

Production of Spectra.—Only comparatively few substances give spectra in the Bunsen flame, the chief of these being the compounds of the alkali metals, and of thallium, barium, strontium, and calcium. The spectra of the last three are probably those of the metallic oxides. For other elements higher temperatures are needed, and these are obtained either from the electric spark or the electric arc. The sparks of a powerful induction coil should, if possible, be made to pass between electrodes of the metal to be examined. If only solutions can be obtained, we may use carbon electrodes¹ of ordinary drawing charcoal, made first of all to conduct by long ignition at a white heat, sharpened to a small cone by means of a pencil pointer, freed from impurities by boiling out with hydrofluoric acid, sulphuric acid, nitric acid, and hydrochloric acid, and finally saturated with the solution to be investigated. These cones are set on the pointed platinum wires serving as electrodes by means of holes drilled in their base. To protect the slit from particles shot off by spirting, a thin mica plate should be interposed.

Instead of carbon points we may use platinum electrodes, one of which is surrounded by the liquid. This is done by passing a rather wide capillary over the platinum wire, and supplying the liquid to this. Every spark then disperses some of the liquid and forms the spectrum. The lower electrode may take the form of Fig. 113: *p* is a stout platinum wire sealed into a glass cup about as large as a

¹ Bunsen, *Pogg. Ann.*, 155, 250, 1875.

thimble; c is a somewhat conical capillary, made by drawing out a wider tube, which can be slipped over the wire and changed if necessary.

Hartley recommends graphite electrodes arranged in the same way, the capillary rise of the liquid being here effected by a few small channels cut in the surface. The electrodes are bevelled like a chisel and placed so that the edges lie in the optical axis of the spectroscopie, the spark thus remaining always in the field of vision.

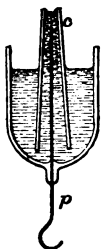

FIG. 113.

For the arc light, carbons bored out axially are used, the substance being stamped into the channels in the form of a wick. Extremely luminous spectra are obtained in this way. The wick carbon is made the positive electrode, an ordinary carbon forming the negative electrode. The spectrum contains numerous carbon bands which must

be taken account of.

Spectra corresponding to high temperatures may also be obtained by means of the oxyhydrogen flame, in which the substances are volatilised.

Colorimetry.—If two solutions of the same coloured substance contain it in different concentrations, two layers of a thickness inversely proportional to the concentration will show the same depth of colour. A method of optical analysis may be founded on this, by the comparison of a layer of unknown concentration with a layer of known concentration, whose thickness is altered until the depth in both layers is the same. If c_0 and c are the concentrations, d_0 and d the thickness of the layers, we have

$$c_0 d_0 = cd, \quad \text{and therefore } c = c_0 \frac{d_0}{d}.$$

The apparatus by means of which such comparisons are made consists essentially of two cylinders, each with a perfectly plane bottom and a side tube provided with a stopcock. On the cylinder there is a scale of millimetres, or double millimetres, beginning from the bottom as zero. One cylinder is filled with the standard liquid up to the division 100, and the height of the liquid in the other is varied until both have the same depth of colour when viewed lengthwise.

As the eye is not very sensitive to differences of intensity, the two fields of colour must be made to touch without a border in between. This condition is imperfectly fulfilled in the colorimeters usually employed. They have two mirrors, s_1 and s_2 (Fig. 114), set above the measuring cylinders at an angle of 45° , and a rectangular prism, p , composed of two similar mirrors. The eye is placed above the lens l , while the inclined illuminating mirror B throws the light upwards. The field of vision is interrupted by the border of one of

the mirrors constituting p , and an exact comparison cannot easily be made.

It is much better if the prism p is replaced by one made of milk-glass, with its upper edge very carefully ground, and the whole left dull, not polished. The two fields then touch quite sharply, and the disappearance of the border line is a good indication of the equality of colour.

The adjustment can be still further improved by adding a difference of colour to the difference of intensity. This is done very simply by the interposition of coloured films between the eye and the prism. If, for example, two blue liquids are to be compared, there is introduced a yellow film of such a shade as to produce as neutral a green as possible. If the layer on the variable side is too thin, it appears not only brighter but yellowish-green; if it is too thick, it appears darker and bluish-green. A similar result is obtained with a red film, which produces a neutral violet. For every coloured solution to be examined, one or several specially suitable films have to be sought out. As long series of experiments with solutions of the same colour have usually to be made, some care taken in seeking out the proper shade is subsequently well repaid by the ease of measurement.

The films are made of coloured gelatine as follows:—The colourless gelatine is allowed to swell up for a few hours in cold water, the excess of which is then poured off, and the residue melted on the water-bath with the addition of a suitable soluble colouring matter. Plane glass plates are then rubbed over with a solution of wax in ether, placed horizontally, and covered 1-2 mm. deep with the coloured gelatine, to which a little glycerine has been added. After drying for several days the films can be removed from the plates, and are then stretched on cardboard or zinc frames, which are laid on the eye-piece of the colorimeter.

Another method is to use a strip of glass 10 cm. long and 2-3 cm. wide, without a covering of wax, and tilted up somewhat so that the gelatine is thicker at one end than at the other and forms a wedge of gradually increasing colour, which can be used to seek out the most suitable depth of colour for any given case. Such a glass must be used with its longest axis parallel to the edge of the prism, in order that small differences in the depth of colour on the two sides may act in the same way.

Collodion may be used instead of gelatine, and coloured with sub-

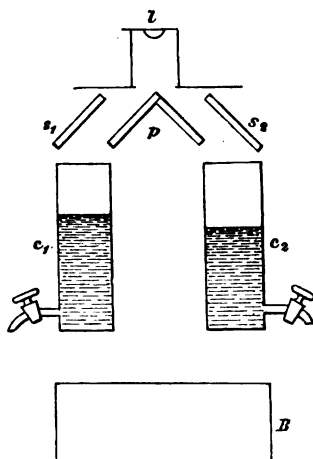

FIG. 114.

stances soluble in alcohol. It possesses the advantage of drying more rapidly, but the films are so thin that they must be left on the glass.

If the coloured solutions have to be changed frequently, we may also use a cell made of two glass plates 1-2 mm. from each other, and filled with liquids of the desired colour. To prepare such a cell a piece of glass rod is bent into the proper form (Fig. 115), cemented

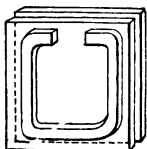

FIG. 115.

on a piece of board which serves as handle, and ground first on one side on a cast-iron plate with emery, and afterwards, if necessary, on a cement plate or a flat tile. After a continuous ground surface is formed, the glass rod is taken off, cemented on again with the ground side towards the board, and the grinding process repeated. The frame thus obtained is laid between two thin plane glass plates,¹

the whole being then held together by a spring clamp and carefully heated until sealing-wax just melts on it. The joints are then followed from the outside with a thin stick of sealing-wax, the melted wax filling up the capillary interspaces without any excess penetrating into the cell. After all the joints are thus made tight, the cell is allowed to cool, and presents the appearance shown in the figure. It is filled by means of a fine pipette, and can be handled without special care, as the liquid does not tend to flow out of the narrow opening on account of the surface tension. If necessary the opening may be closed with adhesive wax.

A wedge-shaped vessel may be made still more easily by placing two object-glasses on each other in such a way that they touch along one pair of short edges, the other pair being kept about a millimetre apart by means of a piece of wire, cardboard, or the like placed between them. They are held together by a spring clamp, and heated so that the sides of the wedge may be filled up with sealing-wax. They must not be heated too highly or the sealing-wax will run irregularly into the interior. In this case also the liquid is held in by capillarity.

The ordinary way of using the colorimeter, the adjustment being made by pouring in liquid or letting it run out through the stopcock, is not a practical one. The side tube ought to be connected by a rubber tube and clip with a funnel which can be raised or lowered. The clip is kept in the hand and the adjustment made by alternately raising and lowering the level of the liquid; at the moment the boundary line in the field of vision disappears, the clip is closed.

The room should be at least half darkened during the observation, and the illuminating lamp shaded. The less the eye is used for other purposes, the more accurately does it make the adjustments.

Spectrophotometry.—The method just described fails when liquids of different colours are to be compared with respect to their absorption in certain regions of the spectrum. In physico-chemical

¹ Microscope slides cut across the middle will usually do.

researches this problem has rarely to be solved, and principally occurs when the concentration of a coloured substance A has to be determined in a solution which contains another coloured substance B . In such a case the absorption is observed in a region where A , but not B , has a considerable absorptive power. The most important feature of the spectrophotometer is that it enables us to give a general measure for the absorption of light by a given substance, which is as characteristic as other properties, such as the boiling point.

In nearly all the different forms of spectrophotometer, the absorbing substance is brought in front of one-half of the slit of a spectroscope, so that two contiguous spectra are obtained—one normal and the other weakened by absorption in the various regions. By a suitable arrangement the first spectrum is enfeebled at the observed place in the spectrum until it is equally bright with the second, and the measured amount of this enfeeblement determines the absorption of the substance. The various spectrophotometers differ chiefly in the means employed to weaken the light. In the apparatus of Glan¹ and Hüfner² the properties of polarised light are used; in the oldest and simplest apparatus of Vierordt the width of the slit is altered.

In order to exclude, as far as possible, from the comparison the weakening due to reflection at the surfaces of the absorbing body, and especially of the cell when solutions are being examined, we may adopt Schulz's plan of placing a piece of glass of definite thickness (usually 1 cm.) in the cell, which is somewhat wider than it, and is placed before the slit so that the upper surface of the glass passes across the middle of the slit. The upper half of the slit, therefore, receives light which has passed through the whole thickness of the solution, while the light of the lower half, with the same losses by reflection, will have gone through a layer 1 cm. shorter. The observed absorption consequently comes from a layer of the solution 1 cm. thick.

The absorption coefficient a is defined by the general relation

$$i = i_0 e^{-ad},$$

where i is the intensity of the transmitted, i_0 of the incident, light, d the thickness of the layer, and e the base of the natural logarithms.

It follows that $\log_e \frac{i}{i_0} = -ad$, or if we adopt decadic logarithms and

make $\frac{a}{2.30} = A$,

$$A = -\frac{1}{d} \log \frac{i}{i_0},$$

¹ *Wied. Ann.*, **1**, 351, 1877.

² *Zeit. f. physikal. Chem.*, **3**, 562, 1889.

and if, as usual in Schulz's method, $d = 1$, then

$$A = -\log \frac{i}{i_0}.$$

The magnitude A is usually termed the absorption coefficient. It may be defined as the reciprocal of the thickness of the layer d , which makes $-\log \frac{i}{i_0} = 1$, or $i = \frac{1}{10}i_0$. This is the thickness by which the incident light is weakened to a tenth. If c is the concentration of a substance, then we have equal absorption when cd is constant. If the specific absorption coefficient A_0 has been determined for unit concentration, and if for the unknown concentration c we obtain the absorption coefficient A , then $A = cA_0$, and $c = \frac{A}{A_0}$. In this way the concentration c may be found from a determination of the ratio $\frac{i}{i_0}$.

The definition of the specific absorption coefficient, or of unit concentration, would, on the rational metric system, give us a concentration of 1 g. in 1 cc. The thousandth part of this, 1 g. per litre, is used as the practical unit of concentration, and the specific absorption coefficient is consequently the negative logarithm¹ of the ratio $\frac{i}{i_0}$, if 1 g. of the substance is dissolved in 1 litre, and observed with a Schulz glass 1 cm. thick.

To determine the ratio $\frac{i}{i_0}$, we have in Glan's photometer the reading α on the divided circle of a Nicol, which gives $\frac{i}{i_0} = \tan^2 \alpha$. In Hüfner's photometer $\frac{i}{i_0} = \cos^2 \alpha$. In Vierordt's apparatus $\frac{i}{i_0} = \frac{\delta_0}{\delta}$, where δ and δ_0 are the breadths of the slit corresponding to the two spectra; δ_0 and δ are read off on the divided heads of the screws moving the jaws of the slit.

For details of the working of the two polarising photometers, the reader is referred to the original sources quoted above. The simplest apparatus to use is Vierordt's, which is conveniently constructed by H. Krüss of Hamburg in the form of a universal spectrometer. It is a spectroscope with a divided slit, the two halves having independent motion read off on the divided heads of the screws. In front of the slit there is placed a Hüfner-Albrecht rhomb (Fig. 116, *R*), in such a position that its edge just falls at the junction of the two slits (s_1 and s_2); in front of this again there is the absorption cell (Z) and

¹ As $\frac{i}{i_0} < 1$, $\log \frac{i}{i_0}$ must always be negative, and $-\log \frac{i}{i_0}$ positive.

the Schulz glass (*K*), with its upper surface also at the height of the edge of the rhomb, and finally there comes the lamp (*A*). A Welsbach incandescent gas-burner may be used with a ground glass plate interposed, so as to obtain a large uniformly illuminated field. Light from the side is carefully shaded off. The path of the rays in front of the slit is shown in the figure. The rhomb serves to bring the two pencils of light into exact contact in the plane of the slit.

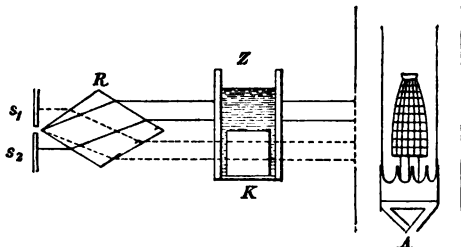

FIG. 116.

In using the apparatus we must first test if the zero on the screw heads corresponds with the closed slit, after which the region of the spectrum to be investigated is found with the telescope and narrowed down by the movable shutters in the eye-piece until only light of the desired colour is visible. The rhomb is then placed so that its front edge coincides as nearly as possible with the junction of the two halves of the slit, this being done most easily by opening one half much wider than the other. Finally, the absorption cell is interposed. The upper slit is set at a definite breadth—say 100 or 200 divisions on the screw head—and the other is then narrowed down until the two parts of the field of vision present the same appearance.

To correct for any differences in the field of vision, it is well to set the lower slit to the width 100 or 200, to fill the cell with water, and move the upper slit until equality is attained. The position of the upper slit then remains unchanged, and is taken as being equal to 100 or 200, whatever the actual value may be.

More detailed directions and useful tables for colorimetry and spectrophotometry will be found in G. and H. Krüss's *Kolorimetrie und quantitative Spektralanalyse*, Hamburg and Leipzig, 1891.

Photography.—The physical chemist has frequently occasion to make use of photographic processes, so that he should not neglect to acquire the necessary experience in manipulation. A stout camera with a long bellows should be selected, the size being 12 × 16 cm.; smaller plates can be used with carriers. A rectilinear lens is the best, as it gives no distortion, and the focal distance should be chosen a little less than half the length of the extended camera. Photographs can then be taken up to life-size, and for special cases, where long focal distances are required, the back lens of the rectilinear combination can be used alone. For taking objects quite close, a wide-angle lens of short focus is employed.

The plates may be purchased ready for use; they are unpacked in

the dark room,¹ carefully dusted, and laid in the plate box. The sensitive side is recognised by its dull surface.

The adjustment is made by means of the ground glass on the camera; if necessary, with a magnifying lens. If it has to be very sharp, a transparent plate with separate fine lines drawn on it with a diamond is moved until both image and lines appear simultaneously quite sharply defined when looked at with a lens. A millimetre scale on the base of the camera is exceedingly useful. If the adjustments for different positions of the object have once been determined with a given objective, a very rough measurement of the distance of the object is all that is necessary to adjust the back of the camera on the scale with all needful sharpness without making the troublesome observation of the image on the ground glass. To construct this table, which is done once for all, a very sharply defined object should be used (black lines on translucent paper illuminated from behind) along with the largest diaphragm of the objective. If the object is distant more than 5-10 focal lengths, the method is no longer practicable.

In taking objects which do not lie in one plane, and in all photographs where the greatest possible sharpness is desired, small diaphragms should be used. The time of exposure is inversely proportional to the square of the diameter of the diaphragm.

While the object is being taken, neither it nor the camera must be disturbed. If the illumination in badly lighted inner rooms, etc., is so unfavourable that a displacement during the necessarily long exposure is to be feared, a magnesium flash will often be found useful, magnesium powder being blown into a large flame. Sufficient light is obtained in small rooms with 0.1 g. magnesium and a diaphragm $\frac{1}{10}$ to $\frac{1}{12}$ the focal length of the objective, other conditions being easily estimated.

The development of the exposed negative is also done in red light. If only single photographs have to be taken, the developer may be bought ready-made; for a series of photographs it is best to prepare it oneself. The hydroquinone developer is most suitable for beginners. A sufficient quantity of the developer² (at least 120 cc. for a 12 × 16 cm. plate) is poured into a flat dish, of enamelled iron or the like, which is raised at one end so that the liquid collects at the other. The plate is then placed in the dish with the dull side up, and the dish brought back sharply to the horizontal position, a stream of liquid thus flowing suddenly over the plate. The dish is moved several times in this way with as little exposure to light as possible, covered with an opaque plate (a piece of cardboard or clean ebonite), and left several minutes to itself. With proper exposure the

¹ If there is no dark room, the work must be done in the evening, which, with a little care, answers quite well.

² The developers sold have mostly to be diluted with water before use; the directions given with each are followed.

picture appears in a few minutes, varying according to the temperature; the plate is left in the developer until the blackest spots on the back of the plate are just recognisable, or until the unexposed white edges of the plate begin to colour.

The plate is next placed in a dish which contains 1-2 % acetic acid solution, and after some time in a 20 % solution of sodium hyposulphite, in which it remains until the white film of undissolved silver bromide has disappeared when viewed from the back. This usually takes about ten minutes. The plate is then washed for at least an hour in water which is often changed, or better, in running water, and then set up to dry.

Any measurements that have to be made must be done exclusively on the negative, the film on which bears all the various operations without the least distortion.

For making positives, sensitised paper is exposed behind the negative in a printing frame until the picture appears a good deal darker than it is intended to be finally. After exposure it is placed in a toning and fixing bath, which may be bought as well as the printing paper ready for use. At first it becomes yellow and then slowly passes from brown to violet. The action is interrupted before the last stage is reached, and the positive washed for one or two hours in running water. For mounting, the edges are covered 1-2 mm. deep with a good gum (isinglass) while the paper is still moist. It is then spread out carefully on the mount, a piece of bibulous paper laid over it and pressed down. Finally, it should be allowed to dry under weights or in a press.

Photographic Recipes.—Hydroquinone Developer—

A. Hydroquinone	. 10 g.	B. Potassium hydroxide	. 50 g.
Sodium sulphite	. 20 g.	Potassium ferrocyanide	15 g.
Water	. 100 cc.	Water	. 100 cc.

The solutions are made up separately, the first one with application of heat, mixed, and preserved in bottles which are quite filled and closed with india-rubber stoppers; corks are destroyed by the alkali, and glass stoppers stick. For use the developer is diluted with five times its volume of water, *e.g.* about 10 cc. of each solution are added to 100 cc. water. If the plates incline to fog, a few drops of a 10 % potassium bromide solution are added. In summer 6 to 8 volumes of water are taken. The development takes place very quickly, and should be finished in ten minutes at the utmost. Six or eight plates may be developed in the same solution, which it is well to preserve after use, in order to mix it in the proportion 1:2 with fresh developer, which then acts somewhat more slowly and much more clearly.

Intensifying.—A convenient intensifier for plates that have

turned out too thin may be made by adding potassium iodide solution to a saturated solution of mercuric chloride until the precipitate of mercuric iodide is almost entirely dissolved; from 10 to 20 volumes of water are then added. The well-washed plates assume a greenish-gray colour (from mercurous iodide) in this solution, and increase considerably in intensity. They are afterwards again well washed.

For weakening plates a dilute hypo fixing solution is used with the addition of small quantities of a solution of potassium ferricyanide. The silver on the plate dissolves up slowly by reducing this salt to ferrocyanide, the process being interrupted at the right moment. The operation is conducted in daylight, and the plates must be carefully washed after this treatment.

Toning and Fixing Bath—

Sodium thiosulphate	175 g.
Sodium chloride	45 g.
Alum	20 g.
Ammonium sulphocyanide	10 g.
Water	1 litre.

The whole is allowed to stand for some days to settle, after which so much gold chloride solution is added that about 0.1 g. gold is contained in 1 l. of the bath. The bath may be used frequently if some fresh thiosulphate is added from time to time; when yellow middle tones begin to appear, it is thrown away.

Rotation of the Plane of Polarisation.—Liquid organic substances occasionally possess the property of rotating the plane of polarised light which passes through them. The angle of rotation α is proportional to the length of liquid passed through and is dependent on the wave-length and the temperature. The relation between the angle α and the wave-length λ can be expressed by the equation

$$\alpha = \frac{A}{\lambda^2} + \frac{B}{\lambda^4};$$

nothing of a general character is known as to the influence of temperature.

This property of substances is so far connected with their chemical nature that it is only apparent in substances which contain an asymmetric carbon atom, *i.e.* one which is bound to 4 atoms or radicals all different from each other. Such substances occur as a rule in two forms—one rotating as much to the right as the other does to the left.

The molecular rotation $[m]$ is most rationally defined as the angle through which 1 gram-molecule of the substance in a tube of 1 sq. cm. section rotates polarised light of a definite wave-length, usually sodium light. As the numbers obtained in this way generally turn out too large, a unit ten times the above is adopted; but for the sake of consistency in carrying out the “absolute” system of measurement the smaller unit should be chosen. If α is the angle through

which a layer l cm. long of a substance with the molecular volume ϕ rotates the plane of polarisation, then the molecular rotation is

$$[m] = \alpha \frac{\phi}{l} = \alpha \frac{m}{d},$$

where m is the molecular weight and d the density, so that $\phi = \frac{m}{d}$.

The same definition applies to solutions, ϕ being then the molecular volume of the solution, *i.e.* the volume in cc. which contains 1 gram-molecule of the substance. For m , the weight of solution containing the same quantity is taken. The molecular rotation in solutions depends on the nature and quantity of the solvent, and we determine, when possible, the limiting values for the quantities 0 and ∞ of the solvent.

For measuring the optical rotation Wild's polariscope and the half-shadow instruments of Jellet and Cornu are those chiefly used, the latter being in general to be preferred. The instruments consist of two Nicol's prisms, between which the tube containing the liquid is interposed, and differ only in the means employed in determining the position of one of the polarisers to the plane of polarisation. In Wild's apparatus a Savart polariscope is used, which in general shows parallel interference bands in a small ocular telescope which vanish when the planes of the two Nicols are parallel or at right angles to each other, *i.e.* four times in a complete revolution. By turning the Savart polariscope relatively to one of the Nicols, two of the adjustments may be made more sensitive at the expense of the others, for the vanishing and reappearance of the bands in the middle of the field take place with much smaller rotations in the favoured two.

To use Wild's apparatus, the tube is first filled with water, closed with the glass plates and caps, and laid in the apparatus, which is then pointed at a bright sodium light. The eye-piece is now moved until the horizontal bands appear as sharply defined as possible; the index should not then be at zero. Now by turning the further Nicol by means of the button at the end of the driving rod into the zero position, the bands are seen to divide in the middle and retire to both sides of the field. If the rotation is continued they approach again, and the adjustment is made for the position at which the reversal just takes place, *i.e.* at which the field is freest from bands. The zero-point is first determined in this way and its correction ascertained if necessary. The tube is then filled with the substance to be investigated, and the observation repeated; the difference of the two readings gives the angle of rotation.

The half-shadow instruments, which are much more convenient in use, are constructed on the following principle:—At the objective end two beams of polarised light are produced, their planes being slightly (1° - 5°) inclined to each other. These fall into a rotating Nicol

whose plane is perpendicular to the plane of the objective Nicol. There will, therefore, be two positions of the latter, distant from each other by the same small angle, at which the right or the left beam will be extinguished; between the two there is a position at which the two appear equally bright, and the adjustment is made to this. To determine the equality as closely as possible, a telescope is carefully sighted to the dividing line of the two beams where they are generated.

Various methods of carrying out this idea have been tried; at present the principal forms are those of Laurent and Lippich. In Laurent's apparatus, which is comparatively cheap, a quartz plate of definite thickness, covering half the field of vision, is used to produce the two beams. The thickness of the plate is so chosen that the transmitted yellow light suffers a difference of phase of half a wavelength. When the polariser at the objective end is inclined at the desired small angle to the quartz plate, we have, meeting at the edge of the plate as middle line, the two beams inclined to the right and left.

In Lippich's apparatus the same object is attained by a second smaller Nicol at the objective end covering half the field. The apparatus is, therefore, more costly to construct, but it has the advantage of being applicable to all sorts of light, whereas Laurent's apparatus can only be used for one sort, or must have a different quartz plate for each wave-length used.

These instruments are used in the same way as Wild's; a tube filled with water is introduced, the telescope is accurately adjusted to the dividing line of the two portions of the field, the zero is determined, the liquid substituted for the water, and the reading made.

The Observing Tubes.—The following form, which is quite practical, is usually adopted for the observing tubes:—A thick-walled glass tube is ground at the ends exactly perpendicular to the axis and provided with brass tubes which are cemented on, and have a very broad and deep screw cut on them, so that the screwing on and off of the caps does not occupy too much time. These caps are also made of brass and are used to press tightly on the glass plates which close the ends, india-rubber rings being interposed. The tube is surrounded by a sheet-metal or glass jacket in the form of a Liebig's condenser, through which water of a definite temperature is passed. This last arrangement is indispensable, a fact which should be borne in mind on the purchase of new instruments.

Before filling, the tube is first of all cleaned by screwing off the caps and pushing through it rolls of soft linen by means of a rod of wood or other non-metallic material. One plate is then cleaned and screwed on by means of its cap. A soft rubber ring is first placed in the cap, which should not be screwed up too tight, as the plate easily

becomes birefringent from the pressure, and may thus give rise to grave errors. The tube is then inverted and filled with the liquid until a very flat meniscus appears above the upper end. The second plate is cleaned and pushed over the end sideways so that the excess of liquid is swept off before it; in this way the tube is filled quite free from air-bubbles. The second cap is screwed on with the same precautions as before, the jacket is connected with the supply of water at constant temperature, and after the temperature has had time to be equalised, the reading is made. The reading is repeated say five times and the mean taken.

The rubber tubes are taken off the jacket in the order which permits the water in the condenser to run out, one of the caps is taken off and the contents of the tube poured out. The tube is then inverted and cleaned after removal of the other cap. The tubes must always be preserved clean and dry, otherwise the caps with their screws stick fast by corrosion.

CHAPTER XII

VISCOSITY AND SURFACE TENSION

Viscosity.—The volume of liquid v flowing from a long capillary tube is

$$v = \frac{\pi p r^4 t}{8 \rho l},$$

where π is 3.1416, p the pressure, r the radius, l the length of the tube, and t the time; ρ is a factor depending on the nature of the liquid and on the temperature, and is called the coefficient of viscosity. It is consequently found by means of the equation

$$\rho = \frac{\pi p r^4 t}{8 v l},$$

and is given in the absolute metric system if the pressure is expressed in ergs \times cm⁻³, the radius and length in cm., the volume in cc., and the time in seconds. Its dimensions are those of a pressure multiplied by a time, viz. [$el^{-3}t$].

If the liquid issues from the tube with a finite velocity, the coefficient of viscosity must be diminished by the amount $\frac{sv}{R\pi g}$, where g is the gravity acceleration 981, and s the specific gravity of the liquid. The factor R , according to Hagenbach, is equal to 2³⁴ or 10.08. Finkener and Wilberforce, on the other hand, make it equal to 8, and this is probably more correct.

Besides this magnitude, the relative viscosity η is used, the viscosity of water at 0° or the temperature of experiment being made equal to unity.

In carrying out the determination, attention must be paid to make the correcting term as small as possible. As it depends on the energy of motion of the liquid as it leaves the tube, it is proportional to the square of the linear velocity, which should therefore be reduced by employing small pressures and tubes of corresponding width.

A suitable apparatus which I constructed some years ago is shown in Fig. 117. The liquid flows under its own pressure through the capillary bd . An accurately known quantity is introduced at f , and sucked up at a until the liquid has risen above the mark c . The time occupied by the liquid in flowing down from c to the lower mark d is noted. If t_0 is the time for the standard liquid, whose specific gravity is b_0 and coefficient of viscosity η_0 , the corresponding values for any other liquid are related to them as follows:—

$$\eta : \eta_0 = st : s_0 t_0 \quad \text{or} \quad \eta = \eta_0 \frac{st}{s_0 t_0},$$

where we put for η_0 the absolute value determined in some other way; or, if only relative numbers are needed, we make it equal to 1.

A stop-watch, such as is used for timing races (price 25s. upwards), is very convenient for measuring the time. The long centre seconds hand is liberated by pressing a button, and stopped by pressing it again; a third pressure brings the hand back to zero. The dial is divided into fifths of a second, the whole minutes being read off by means of another small hand.

The capillary should be 10-12 cm. long, and the bulb k so large that the time of outflow is at least 100 seconds.

The viscosity changes very rapidly with the temperature, on the average about 2 per cent per degree, which is the same as the temperature coefficient for the conductivity of electrolytes. The temperature must therefore be kept very constant, best by means of a thermostat. Dust and suspended particles which were so troublesome to the older observers who used narrow horizontal tubes, have little effect with the above apparatus except in extreme cases.

Other methods, such as Coulomb's swinging disc method, are not only much more difficult both in execution and calculation than the outflow method, but give more doubtful, or more inaccurate results. They may therefore be now considered as given up.

Surface Tension.—The work e necessary to form a surface ω is proportional to this surface and to a factor γ which depends on the nature of the substance and on the temperature. From $e = \gamma\omega$ we have surface tension defined by the relation

$$\gamma = \frac{e}{\omega}.$$

The coefficient γ is of considerable interest, as it stands in intimate

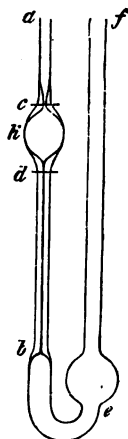

FIG. 117.

relation to the so-called molecular properties of substances. It diminishes very nearly proportionally to the temperature and vanishes at the critical point. The methods of measuring it are not yet sufficiently well developed, so that the determinations are still somewhat difficult and uncertain.¹

If a cylindrical tube of radius r is placed in a liquid by which it is wetted, the liquid rises in it to a height h given by the equation

$$h = \frac{2\gamma}{rs}, \quad \text{whence } \gamma = \frac{1}{2} hrs,$$

s being the specific gravity of the liquid. If the tube is not wetted by the liquid there is a depression to the same extent. The capillary rise h , the radius r , and the specific gravity s have therefore to be measured in order to ascertain the surface tension γ . For the specific gravity see p. 90. The radius of the tube is measured on the dividing engine or by weighing out with mercury, a calibration having first to be performed. It can only be ascertained if the tube has a cylindrical bore, by breaking it at several places, and measuring diameters perpendicular to each other. For this purpose the calibrated tube is cut across evenly with the glass-cutter, and the bore measured in the plane of the section by means of the microscope and dividing engine. Small irregularities in the bore cause no special error if the tube is carefully placed parallel to the optical axis of the microscope.

The height h is read off most conveniently on a scale on the tube. As the upper surface is not plane, a correction must be made; in narrow tubes this is done by assuming the surface to be hemispherical and adding $\frac{1}{2}r$ to the height measured up to the lowest point of the meniscus.

The setting up of the apparatus depends on circumstances. For the ordinary temperature Röntgen and Schneider's² arrangement may be adopted. The lower end of the divided capillary is passed through the cork of a small bottle containing the liquid, and having a plane side made by grinding and cementing on a piece of plate-glass. A short glass tube passes through a second hole in the stopper and is attached to a rubber tube, by means of which the air in the bottle can be compressed or rarefied so as to give the necessary motion to the liquid in the capillary.

The upper portion of the capillary, in which the meniscus appears, is provided with a water jacket in the form of a Liebig's condenser, through which water of a definite temperature can be passed. As the capillary rise depends largely on the temperature of the meniscus,

¹ [For the latest accurate work, see Ramsay and Shields, *Phil. Trans.*, **184**, 647, 1893.—Tr.]

² *Wied. Ann.*, **29**, 202, 1886.

and is only altered by that of the other portions in so far as their specific gravity is affected, small variations of the laboratory temperature are thus rendered harmless.

The most important point is to have a perfectly clean surface at the meniscus, for the rise is determined by the surface tension at this place, and owing to the small extent of the meniscus, the least trace of impurity exercises an exceedingly large disturbing influence. The surface must therefore be frequently renewed by pressing the liquid out at the top of the tube and removing the excess with a piece of filter-paper. The fingers, which are always greasy, must never come into immediate contact with the solution or the upper portion of the tube.

The lower surface of the liquid is adjusted to a definite division by moving the tube in the stopper, and the meniscus is made to reach its position of rest, once by rising, and again by falling. Röntgen and Schneider in this way got readings concordant to 0.1 mm. with a rise of 100 mm.

For measurements at higher temperatures Frankenheim describes apparatus in the form of U-tubes with limbs of unequal bore, or simply of a narrow tube in the axis of a wide one. In calculating, account must be taken of the radius of the wide tube if it cannot be made so wide that a part of its surface may be assumed to be plane.

R. Schiff¹ used an apparatus of the simple form shown in Fig. 118 for determinations at the boiling point. The enlargement at *a* is essential to prevent stoppage of the mouth of the tube by deposited drops. When a suitable quantity of liquid has been introduced, the apparatus is hung in a cylinder in which the same liquid is boiling, and after 10 to 15 minutes the difference of level is read off either on a scale etched on the tube, or on a strip of glass attached to it—not with a cathetometer.

The complicated apparatus with taps, afterwards used by Schiff, are not free from suspicion on account of the difficulty of cleaning them.

Frankenheim's apparatus with the coaxial tubes may take the form shown in Fig. 119. By blowing and sucking through the side tube the meniscus may be set in motion and renewed. It is best to have the scale on the capillary itself.

With regard to the calculation, we have for the two limbs of the U-tube, with radii r_1 and r_2 —

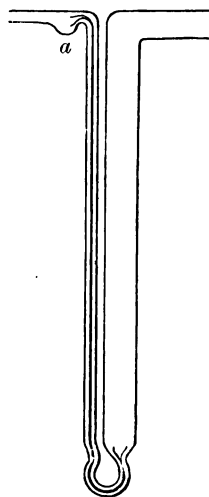

FIG. 118.

¹ Liebig's *Ann.*, 223, 47; *Gazz. chim. ital.*, 14, 1884.

$$h_1 = \frac{2\gamma}{r_1 s} \quad \text{and} \quad h_2 = \frac{2\gamma}{r_2 s},$$

so that

$$h_1 - h_2 = \frac{2\gamma}{s} \left(\frac{1}{r_1} - \frac{1}{r_2} \right),$$

and

$$\gamma = \frac{1}{2} s (h_1 - h_2) \left(\frac{r_2 - r_1}{r_1 r_2} \right).$$

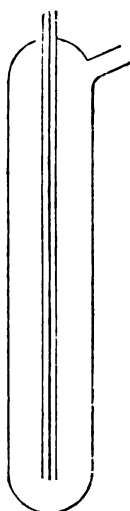

FIG. 119.

With one tube inside the other, the radius of the outer tube is taken to be its internal radius minus the external radius of the inner tube. The height in the capillary is corrected for the meniscus; this correction is better avoided in the second tube by making it very wide.

The method of weighing is closely analogous to the method by the capillary rise. It depends on measuring the force by which a wetted body is just torn apart from the surface of a liquid. If l is the length of the line of contact of the body with the liquid, and f the force necessary to tear it loose, then $\gamma = \frac{f}{l}$. This force is

usually determined by means of the balance and weights. If w is the weight in grams, the force f is gw , where g is the acceleration of gravity, and can be mostly taken as 981. There is a correcting term to be taken into account, viz. the weight of the cylinder of liquid below the cross-section q of the body, this weight being $q\sqrt{2d\gamma}$ where d is the density of the liquid. It is well to make this term as small as possible by giving the body a large line of contact and a small solid section,

i.e. by making it of foil rolled into a cylinder or spiral, and placed edge downwards. The weight is then $w = \frac{\gamma l}{981} + q\sqrt{2d\gamma}$, and the surface tension is

$$\gamma = \frac{981}{l} (w - q\sqrt{2d\gamma}).$$

It is true that in this equation γ occurs also on the right-hand side, but only in combination with a very small factor. In such cases the less convenient solution of the quadratic equation is avoided by first of all neglecting the correcting term, and calculating the approxi-

mate value $\gamma_1 = \frac{981}{l} w$. This value γ_1 is then introduced into the correction, and the expression $q\sqrt{2d\gamma_1}$ calculated, with the help of which we obtain a more accurate value of γ , viz. γ_2 . If this value is now used to get a new correcting term $q\sqrt{2d\gamma_2}$ and a third value of γ

calculated from it, this value γ_3 will usually be found the same as γ_2 within the limits of the experimental error. Should this not be the case, the process of approximation is repeated until the desired result is attained.

As to the working of the above method, details may be found in a paper by Weinberg.¹ Worthington's apparatus,² which consists of a spirally rolled strip of platinum, appears to be very suitable for the purpose, but no data are given to show the accuracy of the results obtainable with it.

Another method is based on the fact that a drop formed on a horizontal circular surface falls off when its weight is equal to the product of the surface tension and the circumference of the base of the drop. If the same surface is always used, the weight of the drop is proportional to the surface tension.

The process is very convenient, but has the essential defect that the whole drop never falls off, as a little of the liquid always adheres to the solid surface, the amount depending on the size of the surface and on the surface tension. If, therefore, the weight is determined by collecting and weighing the drops which have fallen, the value obtained is always too small, and as the portion remaining behind is not proportional to the total weight, the results give no relative measure of the surface tension. To obtain correct results, the weight of the hanging and not of the detached drop should be determined, which may be done, for example, as follows:—

A capillary tube is fastened into the not quite air-tight stopper of a small Erlenmeyer flask (Fig. 120). The flask is weighed after some of the liquid has been placed in it, and the capillary completely filled. The liquid is then allowed to flow slowly from a tube drawn out to a fine point into the upper end of the capillary, the flask being meanwhile kept absolutely undisturbed, until the drop just falls off, when the pointed tube is removed. The flask is again weighed, the difference giving the weight of the hanging drop. To perform the next experiment, the liquid is sucked up at the upper end of the capillary by means of blotting-paper until the residue of the drop on the lower surface is completely removed and the liquid just begins to withdraw itself into the capillary. The flask may now again be tared and the operation repeated.

Jäger³ has described a process which gives very accurate results.

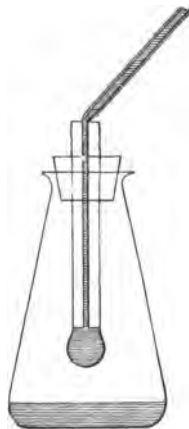

FIG. 120.

¹ *Zeit. physikal. Chem.*, **10**, 39, 1892. Cf. Lohnstein, *ibid.*, **10**, 504.

² *Phil. Mag.*, **19**, 43, 1885.

³ *Wien. Akad. Berichte*, **100**, 245, 1891.

It is based on the formation of air-bubbles in a liquid. If an air-bubble is formed at the lower plane end of a tube dipping into a liquid (Fig. 121), the curvature of the surface increases until the surface is hemispherical, and then diminishes.

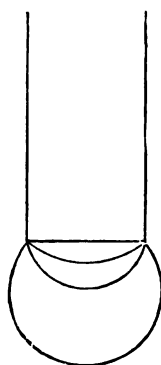

FIG. 121.

Now the capillary pressure in a spherical bubble is $p = \frac{2\gamma}{r}$, where

r is the radius of the sphere. Consequently, as the pressure slowly increases, the bubble will increase in size, but its radius of curvature will diminish. Until the bubble becomes hemispherical its state is stable, but when the pressure is somewhat further raised the radius again increases, the capillary counter-pressure becomes less, so that with one and the same air pressure the increase in size goes on until the bubble detaches itself and a new one is formed. If this limiting pressure at which the bubble becomes unstable is determined (the hydrostatic counter-pressure due to the depth of immersion of the tube being allowed for), the surface tension is given as follows:—

$$\gamma = \frac{1}{2}pr,$$

where r is the radius of the opening, which should be as sharp-edged as possible.

Jäger uses a differential method by immersing two tubes of different widths in a beaker containing the liquid. The tubes are movable on a divided vertical rod, and are connected with the same air space in which the pressure is generated. They are moved with respect to each other until air-bubbles come off simultaneously from both. The product of the difference of level of the two openings and the specific gravity of the liquid is proportional to the surface tension of the latter, and relative values of the surface tension are obtained by using the same pair of tubes in different liquids.

CHAPTER XIII

SOLUBILITY

LIMITED solubility occurs when two substances can unite only partially to form a homogeneous mixture—the solution. Consequently we have, for the most part, to deal with solubility values for gases in liquids and solids in liquids. Solids can also dissolve gases, liquids, and other solids, with formation of “solid solutions,” but these are mostly inaccessible to measurement. With liquids and solids, gases form gaseous solutions of limited composition; with each other, they can mix in all proportions. There are thus eight sorts of saturated solutions, when we consider them with respect to the state of aggregation, the case of gases with gases alone falling out of the nine possible combinations.

Every limited solubility is characterised by the formation of an equilibrium between at least two “phases,” *i.e.* mechanically separable portions of the system. The practical production of saturated solutions, *i.e.* solutions in equilibrium, depends on facilitating this equilibrium by extending the surface of contact between the heterogeneous components as much as possible, and on obviating the persistence of regions of unequal saturation (which must necessarily arise on account of the solution only taking place at the surface of contact) by mechanical stirring and mixing. A fine state of division and energetic mixing are therefore chiefly to be aimed at, especially in making the most important class of solutions, *i.e.* liquid solutions. It is true that without mechanical stirring, diffusion acts in the direction of uniform mixing, but only with such extreme slowness in the case of liquids, that months and years must elapse before practical uniformity is attained; theoretically, it could only take place after an infinite time.

In general we can only know by means of analysis if the state of equilibrium or saturation has been attained. The strength of the solution is determined from time to time, and the efforts to induce saturation continued until several determinations at considerable intervals show no greater differences than might be due to the analytical errors. It is of great importance to reach the state of satura-

tion from the other side by first of all producing a stronger solution than corresponds to saturation (by heating, increase of pressure, etc.), and then allowing it to attain equilibrium. If the same value is obtained from both sides, we may be certain that we are dealing with a real equilibrium, and not an apparent one, due perhaps to the length of time required to reach the final stage.

Liquids in Gases.—The equilibrium between liquids and gases is, so far as the gaseous portion is concerned, regulated by the law that the vapour pressure of a liquid in a gas is the same as in a vacuum. The gas only serves therefore to keep the corresponding space free for the vapour. Consequently, determinations of the vapour pressure of liquids in gases are usually made to ascertain the vapour pressure itself; the gas may for most purposes be neglected.

The production of this equilibrium is very rapid if the "dynamical" method is employed, simply bubbling the gas through the liquid is as a rule sufficient. Only when the liquid is itself a solution, *e.g.* an aqueous salt solution, must care be taken not to alter the concentration by removing the solvent as vapour; this is best done by having two vessels containing the solution one behind the other. In the first one the gas takes up the greater part of the vapour, thereby making the solution more concentrated; the small quantities of vapour that are then removed from the second vessel can mostly be neglected. If this cannot be done, the loss of weight of the second vessel is noted, and the concentration in it calculated as the arithmetical mean of the original and final concentrations, so that we can see if the correction is of importance or not.

Similar considerations hold good if the liquid is somewhat volatile, and is therefore cooled by the evaporation. In this case also it is best to use two vessels so as to have a preliminary and a final saturation.

The weight of the vapour removed may be ascertained either from the loss of the saturation vessels, or by absorbing the vapour in a suitable substance. It depends on circumstances which should be used; the first-named is in general to be preferred.

The nature of the gas is of little importance so long as it is very little soluble in the liquid, for with all liquids the vapour pressure diminishes if foreign substances, no matter what their state of aggregation, are dissolved in them, so that deviations from the proper vapour pressure occur. However, if the solubility is known, the influence may be calculated from the laws governing the vapour pressure of solutions; in the case of oxygen, hydrogen, and nitrogen at the ordinary pressure it is very trifling.

If it is otherwise suitable, therefore, we may use for this purpose atmospheric air which has been previously freed from moisture and carbonic acid by passing over pieces of solid caustic potash. In the

case of liquids affected by the oxygen of the air, hydrogen is employed, and as vaporisation takes place in hydrogen more rapidly than in air, this gas is also to be preferred in cases where there is any special difficulty in vaporising the liquid.

The apparatus necessary for such determinations consists of the saturation vessels, and the parts for the production and measurement of the current of gas. Liebig's potash bulbs are very suitable for the former, two of them being connected up with rubber tubing so that the glass tubes touch each other. India-rubber is somewhat permeable to water, so that dry gases become moist, and those saturated with water vapour lose a portion of their water, when led through any considerable length of rubber tube. It should, therefore, be made a rule to bring the gas into contact with india-rubber as little as possible, all connections being made with glass tubes joined up closely as indicated.

The potash bulbs are filled so that, when slightly inclined, the three lower bulbs are two-thirds full of liquid, while very little is in the upper one when the current is passing. They should be filled at the side through which the air enters, the saturated air thus passing through the dry side tube.

To keep the temperature constant, the apparatus is placed in a thermostat.

The air current required may be produced in various ways. If the volume of air has to be measured, it may be set in motion either by suction or by pressure, its volume being ascertained from the volume of water to which it corresponds.

The principle of Mariotte's bottle may be adopted to secure a uniform current (see p. 190). The exit tube should be bent twice to make a water safety trap when the bottle has run out. It is essential to know the temperature and the pressure of the air current. The former is measured by a thermometer in the interior of the bottle, the latter is equal to the barometric pressure minus the vapour pressure of water corresponding to the temperature.

The tube of the Mariotte's bottle serves also as a manometer to indicate any difference between the external and internal pressures. If the temperature of the aspirator is different from that of the saturation bulbs, the volume read off is reduced to the latter temperature. Further, since the air in the aspirator is saturated with moisture, the volume must be reduced to the dry state by multiplication with $\frac{b-f}{b}$, where b is the barometric pressure, and f the vapour pressure of the water.

We obtain in this way the volume V of dry air, to which a definite weight w of saturated vapour has been communicated at the temperature t . If the vapour pressure is to be calculated from this,

we have the gas equation $pv = RT$, where $R = 84690 \frac{w}{M}$, $v = V$, and $T = 273 + t$; so that

$$p = 84690 \frac{w(273 + t)}{MV} \left[\frac{\text{g.}}{\text{cm.}^2} \right] = 6229 \frac{w(273 + t)}{MV} \text{ cm. mercury.}$$

The second expression is obtained from the first by dividing by 13.595, the specific gravity of mercury.

The statical method consists in measuring the increase of pressure or volume which a measured volume of air experiences when it comes into contact with the liquid in question. It gives concordant results only with great difficulty, so that it need not be described in detail. As a rule a sealed bulb filled with the liquid is placed in the gas chamber, and, after the temperature, pressure, and volume of the pure gas have been read off, it is broken by warming, whereupon the three new values are determined when a sufficient time has elapsed, the interval depending on the construction of the apparatus. If the first measurement is reduced to the volume and temperature of the second, the difference of pressure gives the vapour pressure desired. More certain results are obtained if supersaturation is induced by an intermediate rise of temperature, the system being then allowed to cool. The method cannot be applied to solutions.

Solids in Gases.—Solid substances attain equilibrium with gases only very slowly, so that the dynamical method must be employed with great caution, a very slow current of gas being used, and attention being paid to the production of a very large surface of contact with the gas. The statical method is in this case more frequently employed.

In the special and often recurring case of the vapour from the solid being water vapour (*e.g.* from salts with water of crystallisation), the methods of hygrometry can often be employed with advantage, a limited air space being brought to the proper degree of moisture by means of prolonged contact with the substance, which degree is then determined by means of the dew-point, or better, as "relative humidity" by the application of a hair hygrometer. Special care must be taken in such cases that the powdered crystals are not moist with enclosed mother-liquor, which would occasion much too high a pressure. To avoid this, it is best to allow a portion of the salt to effloresce; the presence of this part does not change the vapour pressure, although any excess of water will be absorbed by it.

It should also be noted that uninjured crystals have mostly a much smaller vapour pressure than crushed crystals; possibly the various faces of the crystal may also exhibit differences of pressure. A constant maximum is always obtained if a coarse powder of crushed crystals is employed.

Gases in Liquids.—The amount of solution of gases in liquids is proportional to the pressure or density of the gas, and the solubility is therefore defined as the ratio of the volume of the absorbed gas to that of the absorbing liquid. If these are v_g and v_l respectively, the solubility is

$$l = \frac{v_g}{v_l}.$$

The solubility l is a function of the temperature, and diminishes with rise of temperature, but is not a function of the pressure, at least not within the limits within which gases obey the simple laws. It depends also on the nature of the gas and of the liquid, and may be used to characterise both.

Various sorts of apparatus have been proposed for the measurement of the solubility of gases, the form shown in Fig. 122 being both more convenient and more exact than the others, and having the further advantage that the solvent does not come in contact with mercury.

The calibrated measuring tube A , with a levelling tube B , has a three-way tap at its upper extremity, by which it is connected on the one hand with the gas-supply, and on the other with a flexible capillary, which in most cases may be made of lead. The absorption vessel C is connected with the other end of the capillary, and is also provided with a three-way tap b and an ordinary tap c with a capillary jet. The absorption bulb is completely filled with the gas-free liquid.

To perform an experiment, the measuring tube is filled with mercury (or, in certain cases, water), and the gas-supply connected with the three-way taps, which are then turned so that the capillary is swept out and filled with the gas. The three-way tap of the absorption vessel is next completely closed, and that of the measuring tube turned so as to allow the gas to enter, where it is saturated with water vapour from a drop of water previously introduced. After some time, the volume, temperature, and barometer are read, and the taps turned so that the measuring and absorption tubes communicate. The levelling tube is then raised, and the lower tap of the absorption vessel opened, an accurately determined quantity of liquid, say 20 cc., being run out into a measuring flask of the proper capacity. The lower tap is now closed, and the absorption promoted by regular agitation. The diminution of volume in the burette is

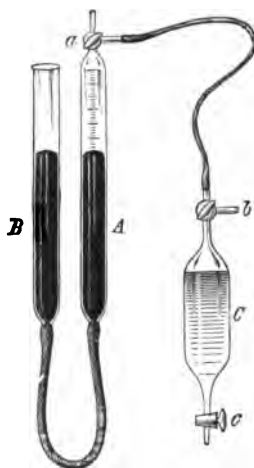

FIG. 122.

followed by means of the levelling tube, until the volume no longer changes even after prolonged shaking. If V is the volume of the absorber, V_0 the volume of the liquid run out, v_1 the original, and v_2 the final volumes of the gas, the solubility is

$$l = \frac{v_1 - v_2 + V_0}{V - V_0}.$$

It is here assumed that the temperature and barometer have not altered during the experiment, and also that the temperature is the same in the measurer as in the absorber.

If the last condition is not fulfilled, as is generally the case when the solubility is to be measured at different temperatures, the absorber alone having then the desired temperature, the volume of gas replacing the liquid run out cannot be simply taken as equal to V_0 , but must be reduced to the conditions prevailing in the measurer. The proper value is obtained by multiplying V_0 by $\frac{pT'}{p'T}$, where p and T refer to the absorber, and p' , T' to the measurer. For p and p' we take the barometric pressure b diminished by the vapour pressures of the absorbing liquid f and of water f' respectively. T and T' are the temperatures centigrade + 273, so that the formula becomes

$$l = \frac{v_1 - v_2 + V_0 \frac{b-f}{b-f'} \cdot \frac{273+t}{273+t'}}{V - V_0}.$$

To obtain the greatest possible accuracy by this method, the dimensions of the measurer and absorber must be properly chosen. For gases which are only slightly absorbed, *e.g.* oxygen, hydrogen, nitrogen, a narrow measuring tube and large absorber are used; for carbon dioxide, nitrous oxide, and similar gases the arrangement is reversed. The solubility of the first class is in round numbers 0.02, of the second class approximately 1.0.

Preparation of Gas-free Liquids.—This is an operation not quite easy to accomplish. The boiling-flask K (Fig. 123) is connected by a thick-walled rubber tube and screw clip with a water-pump through a condenser, and is boiled out under diminished pressure until the liquid when shaken gives the “hammering” characteristic of all liquids free from gas. The clip is then screwed tight, the condenser removed, and the absorber brought into its place. After this is pumped out as well as possible, the clip is opened, and the liquid driven into the absorber either by its own pressure or by slightly warming the flask, after which the absorber is closed.

Chemical Methods.—In all cases where simple and exact analytical methods are applicable, the dissolved gases may be estimated

by saturating the solution and then determining the amount in a measured portion. This may be done with carbon dioxide, sulphur dioxide, sulphuretted hydrogen, and also with oxygen. If the liquid has to be saturated at a pressure less than that of the atmosphere, it is saturated with a mixture of gases (either by shaking or letting the gas bubble through it), in which the partial pressure of the gas in question may be made as small as we please. It is, however, not easy to get large quantities of the mixture of gases to retain a uniform

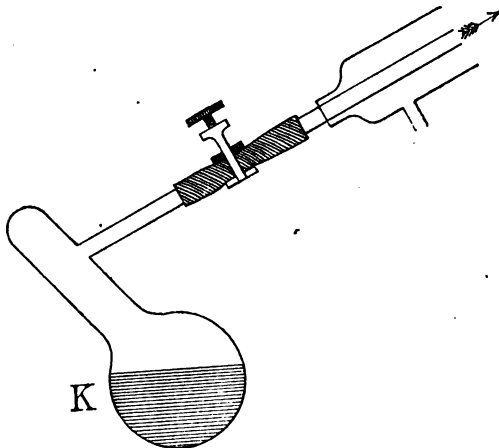

FIG. 123.

composition, as contact with the water which must be employed readily causes variations in the proportions present.

Liquids in Liquids.—In the case of limited solubility, two liquids when shaken together always form two solutions—one of the liquid *A* in *B*, the other of *B* in *A*. These solutions have at a given temperature a composition independent of the ratio of the two liquids, so long as each of the two liquids is present in a sufficiently large proportion as not to be wholly dissolved by the other, which happens when its ratio is less than that for the saturated solution.

The production of such solutions takes place very readily, as the ease with which liquids may be intimately mixed by shaking permits the reciprocal solution very soon to reach the saturation point. The analysis usually presents greater difficulties, and it is therefore best to proceed synthetically by adding *B* to a weighed quantity of *A* until a clear solution of *A* in *B* is obtained; the other state of saturation is determined in the same way.

As the composition of the saturated solution is in a high degree dependent on the temperature, we may also proceed by sealing up weighed quantities of the two liquids in a tube, producing a homogeneous solution by an appropriate change of temperature, and then finding the temperature at which the liquid just begins to become turbid. This is usually more easy to determine than the point at which the liquid becomes perfectly clear. By determining a series of corresponding temperatures and compositions, we have the points on a solubility curve from which the intermediate values may be taken.

Solids in Liquids.—The case most frequently investigated is the solubility of solids in liquids. Here, as a rule, the attainment of saturation takes a long time, for, when the solid is brought as a fine powder into contact with the solvent, the smallest particles, which have the largest surface, are dissolved first, so that, when on account of saturation being nearly reached, further solution takes place more and more slowly, only coarse particles with relatively small surface are left. It should therefore be made a rule to add some finely powdered substance to the nearly saturated solution in order to make the saturation complete. It is best to rub up a little of the substance with a few drops of the solvent, and then add so much of the magma to the almost saturated solution that a cloudy liquid, which only clears up on long standing, is produced.

As the solubility is in great measure dependent on the temperature, a thermostat must be employed during the long time which is always necessary for saturation. It is advantageous to keep the bottle with the solution in continuous motion so that the saturation may be accelerated. An arrangement for doing this is described by Noyes in *Zeit. physikal. Chem.*, 9, 606, and sketched in Fig. 124.

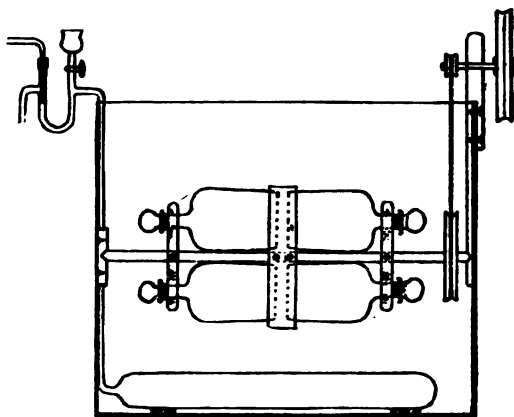

FIG. 124.

Another¹ for smaller vessels is shown in Fig. 125. The vessels containing the solutions should be closed with rubber stoppers, which are more water-tight than ground glass stoppers.

The precautions for securing saturation become the more necessary the lower we choose the temperature of experiment, because the velocity of dissolution and of saturation increases very rapidly with rise of temperatures, and diminishes correspondingly as the temperature

¹ Schröder, *Zeit. physikal. Chem.*, 11, 454.

sinks. At temperatures above 40° or 50° a relatively short agitation (less than an hour) in the apparatus is sufficient.

After saturation has been attained the solution is allowed to settle

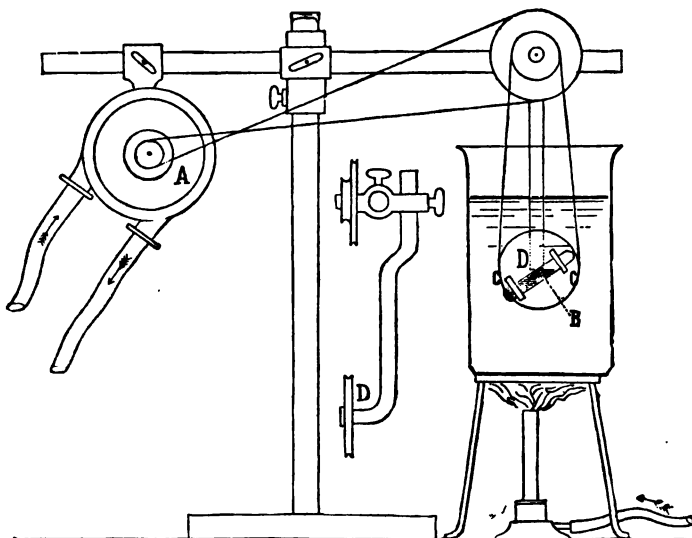

FIG. 125.

at the constant temperature, and the quantity necessary for analysis is taken from the clear portion by means of a pipette. There is a difficulty at high temperatures in preventing loss of liquid by evaporation. We can use in this case either Landolt's pipette (Fig. 126) or the simpler one on the same principle shown in Fig. 127. The pipette is weighed before and after sucking up the liquid, the contents being then removed for analysis, if necessary, by warming and washing out.

In all cases where a definite residue is left on evaporation of the solvent, the analysis may be conducted by simply ascertaining the weight of this residue. If we are dealing with organic substances in volatile solvents, it is best to evaporate in wide-mouthed, stoppered weighing bottles by gentle heating and in a good current of air; the removal of the last portions of the solvent is, however, often difficult. Salts which bear a high temperature are most conveniently obtained from aqueous solution by evaporating in Liebig's drying tubes made of potash glass (Fig. 128). As a large number of similar analyses are usually made together, a small drying oven is constructed of a brass tube closed at one end, with a row of fine holes in it, and a sheet-metal box with wire gauze inside and holes



FIG. 126.

cut out in the long sides for the drying tubes. These are provided with loose-fitting draught tubes, whereby the rate of evaporation is greatly increased; in the joint between the drying and draught tubes a strip of filter-paper should be placed in order to remove the condensed water. The flames are kept so low that boiling does not take place. When no more liquid is visible the heat is increased, the form of the tubes preventing loss by spirting, which almost always occurs. If the drying tubes have been previously treated with steam, they retain their weight during the experiment to a few tenths of a milligram.

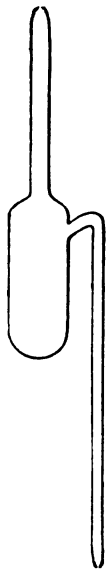

FIG. 127.

Salts, such as magnesium chloride, which are easily decomposed by heating, should be determined analytically, *e.g.* the chlorides by titration with decinormal silver solution.

Physical methods of analysis may also be advantageously adopted when the solutions are pure. For instance, we may determine the relation between specific gravity and concentration for a series of synthetically prepared dilute solutions of the substance, and then bring the saturated solution within the limits investigated by diluting with weighed quantities of water. A determination of the specific gravity of this diluted solution will give the concentration by interpolating on the curve for the synthetic solutions, and from this the concentration of the saturated solution may be calculated. Such a method will be of most use when an extensive series of determinations with the same substance has to be performed.

It assumes a particularly elegant form when a float is employed (p. 96). A float is constructed of a suitable specific gravity, a weighed quantity of the salt is introduced into a glass, and water is added until the float neither sinks nor swims. A weighing of the glass then gives the corresponding concentration. The solution to be investigated is then placed in the dry glass along with the float, and water is added as before. The weight of the whole solution multiplied by the concentration number, determined once for all, gives directly the quantity of salt present. The only condition that needs attention is the temperature, which must be kept constant to about a twentieth of a degree.

Besides the specific gravity any other property which is susceptible of easy and accurate measurement may be used to determine the strength of a solution. The measurement of the electrical conductivity has been of service in the case of very sparingly soluble salts, as it permits the exact estimation of much smaller quantities of salts than either direct analysis or the determination of the specific gravity.

In this case also we may measure the conductivity for a definite strength, and then dilute the given solution until the same conductivity is reached. If the electrodes of Arrhenius's apparatus (Fig. 176, p. 225) are suspended in a large beaker, the dilution to the definite conductivity can easily be done in this. The calculation is the same as with the float, and in this case also constancy of temperature must be attended to, as the conductivity alters by about 2 % per degree.

The results of solubility determinations are mostly represented in curves and tables as parts of salt in 100 parts of water. It is better to give gram-molecules of salt in a kilo of water, as in this way the curves for different salts become comparable. Substances

which contain water of crystallisation should be calculated back into the anhydrous state, as the water of crystallisation is no strictly defined property, but is often variable with the temperature and other conditions.

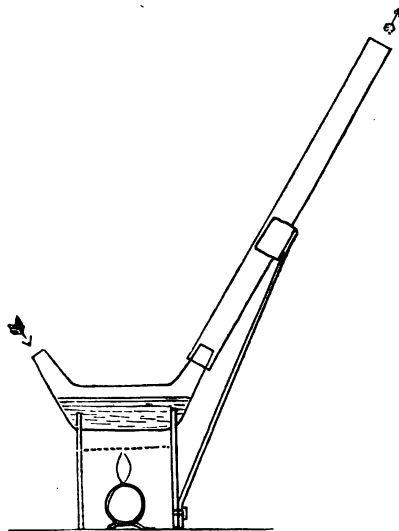

FIG. 128.

CHAPTER XIV

DETERMINATION OF MOLECULAR WEIGHTS IN SOLUTIONS

If the strength of a solution undergoes a reversible alteration, then, in consequence of the change of osmotic pressure, work is done which is the same for equimolecular quantities of dissolved substances, other conditions being equal. All methods of determining molecular weights in solutions rest on this principle; they only differ from each other in the different ways of changing the concentration of the solution, the experimental arrangements being correspondingly different. Of the many possible methods there are two which are of great practical importance, from the circumstance that they are capable of easy and accurate application without special training; these are the determination of the change of the freezing point and of the boiling point.

Depression of the Freezing Point.—The apparatus chiefly used for this purpose is Beckmann's¹ (Fig. 129), which consists of a stout test-tube, *A*, provided with a side tube and sunk into a wider one, *B*, about half its length, so as to be surrounded by an air jacket. The whole is fixed in the cover of a strong glass cylinder, which is maintained at a temperature of several degrees below the melting point of the solvent, and is therefore filled with water, ice, freezing mixtures, and the like. The inner tube is closed by a cork, through which there pass a thermometer and a stirrer consisting of a vertical glass rod, with a ring of stout platinum wire sealed on horizontally at its lower end. The thermometer is of the kind described on p. 119, and is most conveniently divided into hundredths of a degree.

To perform an experiment, a weighed quantity of the solvent is placed in *A*, and the bath regulated to a temperature a few degrees below the melting point. The temperature of *A* is lowered by taking it out of the air jacket and immersing it in the bath directly, until the solvent begins to freeze. The vessel is then wiped and placed in the air jacket, which has remained in the bath; the temperature

¹ *Zeit. physik. Chem.*, **2**, 638, 1888. The apparatus is to be obtained complete from F. O. R. Götze, Leipzig.

is allowed to sink a little, and then the contents are stirred vigorously. A portion of the over-cooled solution solidifies, the thermometer rises somewhat, and then remains constant. If the solvent is homogeneous, this constant temperature is the true melting or freezing point of the substance; otherwise the temperature falls slowly as the solidification proceeds.

The tube *A* is then taken out, and a definite quantity of the substance under investigation added and dissolved by stirring, the ice at the same time being allowed to melt, all but a very small residue. The tube is again placed in the air jacket, the contents are over-cooled, and made to freeze by stirring. The thermometer rises, remains for some time constant, and then falls as the solvent solidifies. The maximum temperature is read off.

The following details must be attended to in making the determination:—Firstly, the quantity of mercury in the Beckmann thermometer is regulated as described on p. 119, by warming it 1-2 degrees above the melting point of the solvent, breaking off the column by a sharp jerk, and then finding if the end is in the upper part of the scale at the melting point. If necessary, the adjustment is repeated.

Carefully fitted corks are used for putting the apparatus together. The tube, with thermometer, stirrer, and corks, is weighed in a large beaker or other support, the amount of solvent to be introduced is judged by the eye, and the whole is again weighed. It is convenient to have some marks on the tube to indicate the quantities of the most common solvents usually taken, *e.g.* acetic acid and benzene. As 15-20 g. of the solvent are used, an ordinary rough balance sensitive to 0.02 g. is sufficient to determine the weight to 0.1 %.

The formation of ice crusts on the bottom of the tube must be avoided during freezing. It is best to allow the liquid to over-cool, and then induce solidification by stirring; under such conditions the ice separates in the requisite fine state of division. Solutions usually over-cool much more than the pure solvents. If there is any difficulty

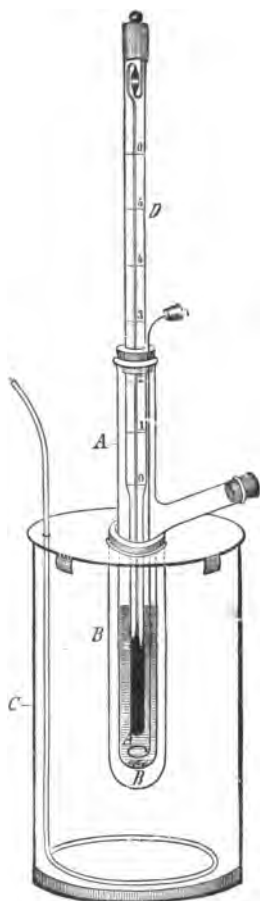

FIG. 129.

in starting the separation of solid by stirring, or if the ice all melts as the substance is dissolved, the freezing may be induced in the manner indicated by Beckmann.¹ A tube with some of the solid solvent at one end passes through the cork to a small test-tube kept immersed in the external bath. To use it, the stirrer is raised out of the over-cooled liquid, the side tube of *A* is opened and the rod of the stirrer touched with the solid solvent, whereupon crystallisation at once takes place on the rod and is afterwards communicated to the whole liquid when the stirrer is lowered and set in vigorous motion.

Some solvents, such as glacial acetic acid, are very hygroscopic, and consequently change their melting point by absorbing traces of water during an experiment. As the molecular weight of water is very small, these traces have a particularly large influence on the freezing point.

To obviate this difficulty Beckmann has proposed the arrangement exhibited in Fig. 130. The stirrer passes through a widened tube through which dry air is led during the experiment, escaping above between the rod of the stirrer and the tube enclosing it. A few drops of concentrated sulphuric acid are contained in the bulbs *F*; a cross plate in the large bulb prevents it from spirting over. The air is got from a water blowpipe, and dried in a special column for the purpose. *E* is a rubber handle, *H* a siphon to remove the liquid from the bottom of *C* when necessary, and *G* a metal dish, in which the apparatus stands, for receiving the liquid.

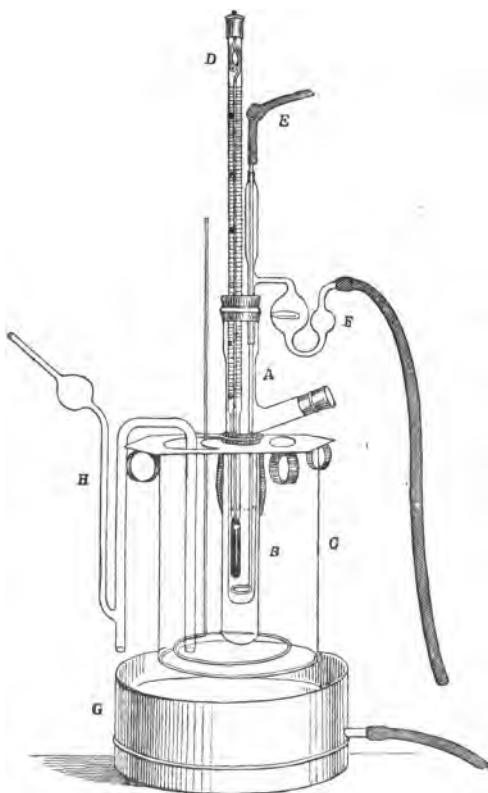

FIG. 130.

When the substance is a solid, it is introduced in the form of powder contained in a

¹ *Zeit. physik. Chem.*, 7, 324, 1891.

long narrow test-tube, so that it can be shaken directly into the freezing vessel without any of it falling on the side tube. The small test-tube is weighed before and after the experiment. Liquids are introduced from a pipette of the form shown in Fig. 131, the same mode of proceeding being adopted. It is always advantageous to make several determinations in succession, fresh substance being introduced on the conclusion of the first measurement, and a new measurement then made.

The result is calculated by means of the formula—

$$M = K \frac{s}{\Delta L},$$

where M is the molecular weight of the dissolved substance, s its weight in grams, L the weight in grams of the solvent, and Δ the observed depression of temperature. K is a constant depending on the nature of the solvent, and has the following values :—

Water	1890
Acetic acid	3880
Benzene	4900
Phenol	7500

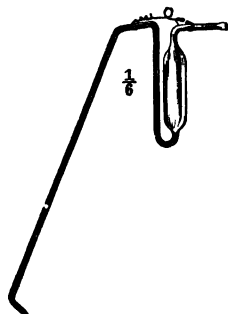

FIG. 131.

Exact Measurements.—The method above described was worked out chiefly with a view to ordinary laboratory practice, the application of small quantities of substance, together with a moderate degree of accuracy in the results, being the principal requirements. If the greatest possible accuracy is to be attained, the scale of the whole experiment must be greatly increased, the quantity of the solvent taken being not less than 500-1000 g. At the same time the delicacy of the thermometric reading should also be increased,¹ although this alone without simultaneous increase in the quantity of liquid is of no avail, as the adjustment of the temperature with small quantities is very uncertain.

The procedure in other respects remains the same. The measured or weighed solvent is placed in a cylindrical glass vessel of suitable size, the lid of which carries the thermometer and is perforated for the passage of the stirrer; this being best constructed in the form described on p. 120. The glass cylinder is surrounded by a somewhat wider and higher metal cylinder which forms the air jacket, and is in its turn immersed in the bath containing the freezing mixture, etc.

¹ F. O. R. Götze, Leipzig, has made an excellent thermometer for me divided into thousandths of a degree, which permits of determinations of temperature to 0.0001 degrees.

A cylindrical pot of enamelled iron, or a wooden pail, answers well enough for this purpose, and is wrapped in felt to minimise the influence of the external temperature. Lids for the middle and outer vessels are also provided for the same end. Fig. 132 shows the arrangement for the special case of aqueous solutions.

As the substance to be dissolved will, as a rule, be present in very small quantity, it is better not to weigh it directly, but to use it in the form of a concentrated solution. The freezing point of the solvent is first determined, and a portion of it is then replaced by the concentrated solution, after which a fresh freezing point determination is made.

In making these exact measurements, it should not be forgotten to allow for the change of concentration by the separation of ice. This can be done by over-cooling and then letting the solution freeze suddenly. If c is the specific heat of the liquid, λ the heat of solidification of unit weight, and θ the over-cooling in degrees centigrade, then the fraction of the total liquid which solidifies when the over-cooling vanishes is

$r = \frac{c\theta}{\lambda}$. For water $c = 1$, $\lambda = 80$, so that for every

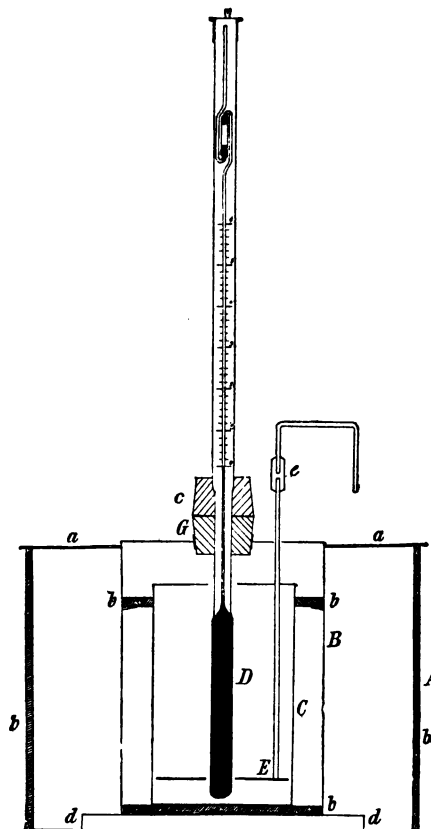

FIG. 132.

degree of over-cooling the remaining liquid is concentrated by an eighth, and instead of the original concentration p , we are, in general, dealing with $p \left(1 + \frac{\theta c}{\lambda} \right)$.

Elevation of the Boiling Point.—A second mode of determining molecular weights is based on the principle that the vapour pressure of a liquid is diminished, when it dissolves foreign substances, proportionally to the concentration, and by the same amount for molecular quantities of different substances.

In view of the difficulty of measuring vapour pressures by the statical method, especially in the case of solutions, no convenient and reliable method has been developed in this line. On the other hand, Beckmann has worked out a dynamical process based on the measurement of the boiling point.

Beckmann's apparatus¹ (Fig. 133) consists of a three-necked flask half-filled with glass beads or purified garnets to produce regular ebullition, which may further be secured by a piece of very thick platinum wire sealed through the bottom of the flask. On the middle neck there is fastened a reflux condenser with a calcium chloride tube; the thermometer passes through the shorter side neck, and the longer one, which is closed with a cork, serves for the introduction of the substance.

The boiling flask with the glass beads, but without the thermometer, is first weighed to 0.01 g., the solvent being then introduced and the weight again determined. The thermometer and condenser are next put in position, care being taken that the condensed liquid does not flow back in the immediate neighbourhood of the thermometer; the asbestos jacket *M* is slipped over the flask, the whole fastened on a stand over an asbestos plate, and the small flame so adjusted

that on the average one drop in ten seconds falls from the condenser. After the boiling has gone on for forty minutes the temperature has usually become constant. The thermometer should

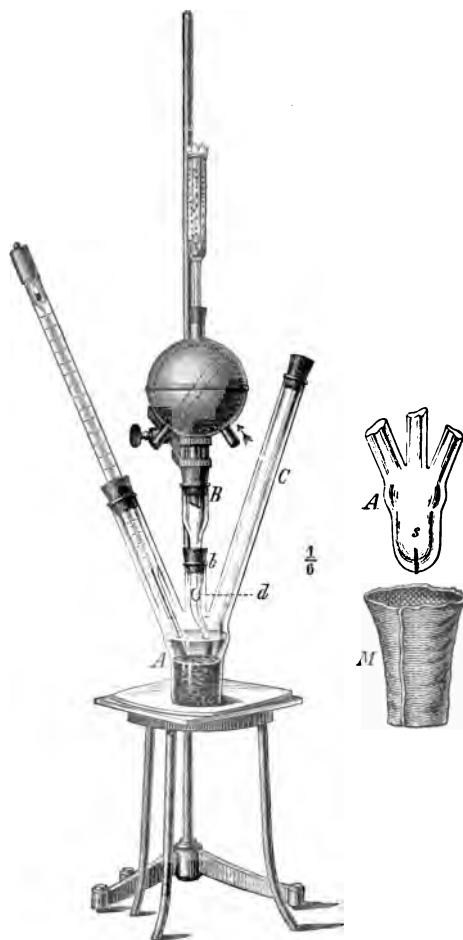

FIG. 133.

¹ *Zeit. physik. Chem.*, 4, 543, 1889.

be tapped gently before reading to overcome the friction of the mercury. The substance is now added, the temperature sinking a few tenths of a degree, slowly to rise again; after five minutes it has usually reached constancy, and is then read off. If more of the substance is at hand a second and a third portion are introduced.

Solid substances are introduced in the form of small flat cylinders made by means of a steel press; the rate of dissolution is much accelerated by the high temperature and the stirring caused by the ebullition. Liquids are introduced from the pipette (Fig. 134), or if they are very viscous, with the valve tube (Fig. 135).

On completion of the experiment the glass beads are freed from

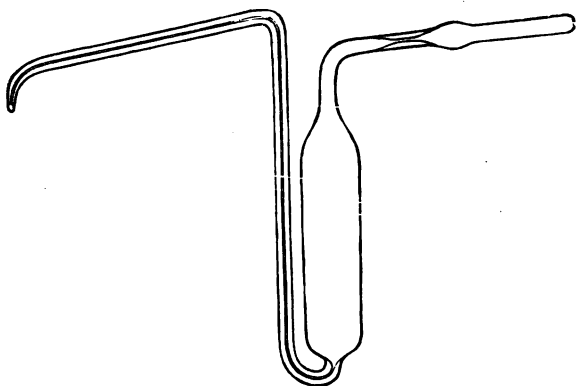

FIG. 134.

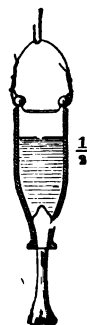

FIG. 135.

the substance in an extraction apparatus and dried; the solvent as well as the dissolved substance can generally be again made fit for use by distillation.

Ether is a convenient solvent in most cases; carbon bisulphide, benzene, alcohol, etc., may be used. Water should only be employed in special cases.

Beckmann has lately¹ altered his apparatus in order to work with small quantities of the solution, and with solvents of any boiling point up to above 200°. The alteration chiefly consists in the employment of a jacket of the vapour of the solvent in which the vessel, shaped like the freezing-point apparatus, is placed.

The apparatus is shown in Fig. 136. The boiling tube *A* has a platinum wire sealed through its lower end, and is filled 3-4 cm. high with glass beads. The thermometer is fastened in the upper portion, and in the side tube there is a condenser *K*₁ (an air condenser in the figure), to which, if necessary, a calcium chloride tube may be added. The boiling tube is placed in the vapour jacket *B*, which is a

¹ *Zeit. physik. Chem.*, 8, 223, 1891.

hollow cylinder somewhat widened above and below, and also carries a condenser K_2 in a side tube attached for the purpose. The vapour jacket contains the solvent with a few pieces of porous tile or of steatite. The whole is built up on a special heating chamber which is constructed of asbestos board and water-glass, and has the form shown in the figure. It serves to carry the heat mostly to the vapour jacket, from which the boiling vessel receives a sufficient quantity, except in the case of water, when a small extra flame must be used. Up to 60° the heating is done with small pointed flames, above that temperature with Bunsen burners.

The substance is introduced through the side tube, the condenser being for a moment removed. With liquids of low boiling point Liebig's condensers must be used, and are chosen short (10-12 cm.) and wide, so that the substance can be put in through the condensing tube at K_1 ; even if it does not fall completely into the boiling vessel it is soon washed down by the condensing solvent.

The solution in the boiling tube is more concentrated than is given by the weighing, as a portion of the solvent during ebullition is removed, partly as vapour, and partly as liquid in the condenser. A correction of 0.2 g., in the case of water 0.35 g., must therefore be deducted from the weight of the solvent.

Glass vapour jackets are very liable to crack, and it is therefore advisable to use one of copper for high boiling liquids. The opacity is no drawback, as the movements of the thermometer afford a sufficient indication of what is going on inside the vessel.

For another form of boiling point apparatus see J. Sakurai (*Jour. Chem. Soc.*, 1892, p. 989). I have as yet had no opportunity of testing it personally.

The calculation is done by a formula quite analogous to that for the freezing point. If Δ is the elevation of the boiling point, s the

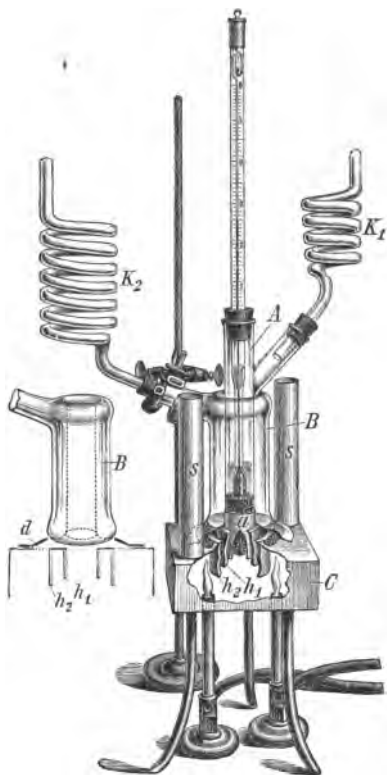

FIG. 136.

weight of substance, L the weight of solvent, and M the molecular weight of the substance, we have

$$M = k \frac{s}{\Delta L}.$$

The constant k has the following values:—

Ethyl ether	2110
Benzene	2670
Chloroform	3660
Carbon bisulphide	2370
Acetic acid	2530
Ethyl alcohol	1150
Ethyl acetate	2610
Acetone	1670
Water	520
Ethylene dibromide	6320
Aniline	3220
Phenol	3040

These values change somewhat with the pressure, and are valid for the mean barometric pressure.

For several special purposes we can use a method worked out at my suggestion by J. Walker¹ for aqueous solutions, and applied later in a somewhat altered form by Will and Bredig² to alcoholic solutions. It depends on the measurement of the ratio of the vapour pressures of solution and pure solvent by vaporisation in an air current.

Two Liebig's potash bulbs containing the solution, and one containing water, are connected with each other. The last is weighed, and is in its turn connected with a U-tube containing pumice soaked in sulphuric acid. A current of air is drawn through the apparatus. The air first saturates itself up to the vapour pressure of the solution, then takes up from the water the quantity of vapour necessary for complete saturation, all of which it finally gives up to the sulphuric acid. The loss of weight of the water vessel is to the increase of weight of the sulphuric acid as the difference between the vapour pressures of the solution and of pure water is to the vapour pressure of pure water.

As this ratio is independent of the temperature within tolerably wide limits, it is not necessary to keep the temperature constant during the whole experiment, which lasts 6 to 12 hours. The various parts of the apparatus, however, must all have the same temperature, so that care must be taken that the apparatus is subject to no sudden and local changes, for which purpose it is surrounded by protecting

¹ *Zeit. physik. Chem.*, **2**, 602, 1888.

² *Berichte*, **22**, 1084, 1890.

walls of a bad conductor, or immersed in a large water-bath. The requisite slow and uniform air current is produced as described in the next section.

Gas Currents, Air-Pumps, etc.—A current of atmospheric air, suitable for vapour pressure determinations, etc., may be obtained for any length of time by means of the small apparatus shown in Fig. 137 (Kekulé). Water is led in through the narrow glass tube *B*, so that it falls in single drops; attached to the lower end of the pump *A* there is a long fall-tube down which the drops run, carrying with them several times their volume of air. If the apparatus is to work uniformly and uninterruptedly for a long time, *B* must be connected with a water reservoir in which a constant level is maintained by means of an overflow pipe. The air is sucked through *C*, and the smaller the pressure to be overcome, the more air is drawn through by the pump, which is only used therefore for small differences of pressure.

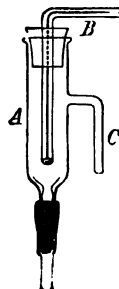

FIG. 137.

The same pump may be used to generate a small excess of pressure by leaving *C* open, and immersing the bent-up end of the fall-tube in a cylinder such as is shown in Fig. 138. The water coming through *F* flows over the edge of the cylinder, while the air passes into the inverted jar and thence to the apparatus.

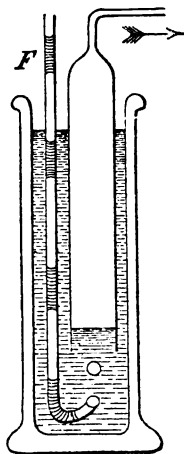

FIG. 138.

If greater differences of pressure are needed, Bunsen pumps are employed, which are to be had either in glass or in brass. The former are to be preferred on account of their transparency and cheapness, which is sufficient to counterbalance loss by breakage. They are made in various forms, that shown in Fig. 139 giving very good results, although I cannot assert that it is actually the best.¹ Individual specimens are often very different in their working; the best ones should be selected from a stock with the help of a manometer.

The Bunsen pump is fastened to the water-tap by wired-on rubber pressure tubing, and is provided at its lower end with a continuation of wide rubber and glass tubing, if this is not a sealed-on part of the pump. It is well to have the tap pretty high above the sink so that the water issuing from the pump may be used for other purposes, this rendering a second tap for ordinary use superfluous.

If the lower end of the Bunsen pump is fastened into a tubulated

¹ [Excellent straight pumps of somewhat wide bore (University College pattern) are to be had of C. E. Müller and Co., 148 High Holborn, London, W.C.—T.R.]

bottle of 2 l. capacity or more, and the outflow of water regulated by the tap in the tubulure (Fig. 140), we obtain a tolerably efficient

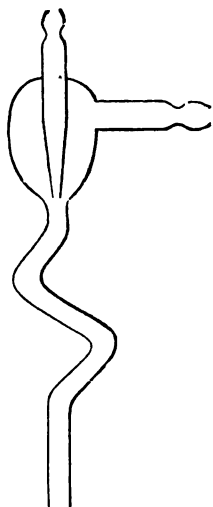

Fig. 139.

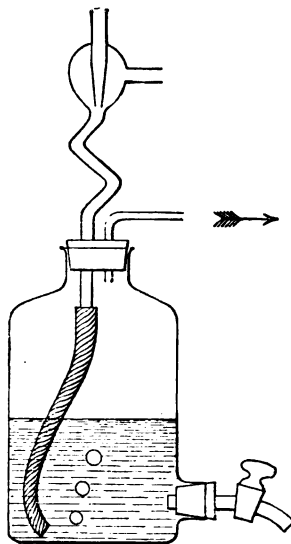

Fig. 140.

water-blast. The outflow should be adjusted so that the bottle when acting remains one-third full of water.

If the pressure of an air current has to be kept constant, a branch is led off to the regulator. With extra pressure this consists simply of a glass tube immersed in an open cylinder filled with water (Fig. 141). The excess of pressure is determined by the depth h of the mouth of the tube under the surface of the water, the excess of gas escaping through this tube. If, on the contrary, diminished pressure is required, a Mariotte's bottle (Fig. 142) is used. Should the pump act too powerfully the air enters through the open tube and a constant diminution of pressure is maintained. For the regulator to be effective the tube should be pretty wide and the current so adjusted that the bubbles ascend in slow succession.

Such adjustments are made with taps, or better, with screw clips. It is usually not quite easy to make anything like a fine adjustment with one clip, as it is just at the effective position that small movements of the clip make a very great difference in the resistance. The adjustment is much easier when two clips are used, one behind the other; the first is made use of to bring about approximate adjustment, the second then permitting the fine adjustment to be made with much greater ease.

For regulating the pressure of other gases, which from any cause cannot be permitted to escape, arrangements are used on the same

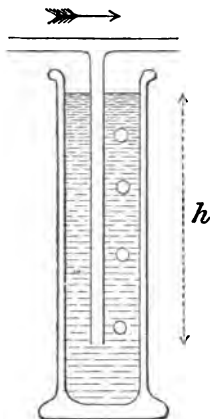

FIG. 141.

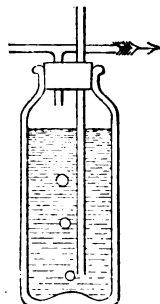

FIG. 142.

principle as is employed for thermo-regulators. The excess of pressure sets a part in motion which hinders the outflow of gas the greater the excess of pressure is. A small floating gasometer (Fig. 143) may have a cone fastened to it which enters the exit tube; an opening *a* is left in the upper part of the gasometer for the passage of the gas. The greater the pressure is inside the bell, the more completely does the cone block the exit tube, the gas current being correspondingly diminished. Such regulators may be purchased from gasfitters; they are usually adjusted to deliver so many cubic feet per hour and cannot be used for other amounts.

On the same principle we have also "dry" regulators which contain, instead of the floating bell, an elastic membrane, subjected to a varying pressure either from weights or springs. These regulators are also used for coal-gas and can be bought ready-made. Elster's pressure regulator has given good results in my laboratory.

A number of different gases, such as carbon dioxide, sulphur dioxide, oxygen, hydrogen, nitrous oxide, ammonia, chlorine, can now be obtained in commerce compressed or liquefied. They are kept and forwarded in metal cylinders, mostly of steel. When in use the great pressure under which they are kept must be appropriately reduced, the necessary taps and valves being supplied by the dealers. In this case also the employment of several taps in succession is very often of service.

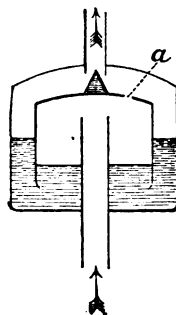

FIG. 143.

CHAPTER XV

ELECTRICAL MEASUREMENTS

ALL electrical magnitudes may be expressed in terms of two factors of electrical energy, viz. quantity of electricity and potential, and all electrical measurements ultimately resolve themselves into the determination of these two factors. In many cases, however, it is possible to attain the desired end by measuring other derived magnitudes, of

which the chief are :—current strength = $\frac{\text{quantity}}{\text{time}}$, resistance = $\frac{\text{potential}}{\text{current strength}}$, conductivity = $\frac{\text{current strength}}{\text{potential}}$ = $\frac{\text{quantity}}{\text{potential} \times \text{time}}$.

The importance of these derived magnitudes lies in the current strength being directly measurable by the commonest electrical instrument, the galvanometer, whilst of all electrical magnitudes, resistances are the easiest to reproduce and to preserve.

Electrical Units.—The units of the factors of electrical energy are so chosen that the unit of electrical energy is equal to 10^7 ergs. The theoretical definition of the factors has been arrived at in an involved and by no means unexceptionable way; we are here concerned exclusively with the practical result. Unit quantity of electricity is practically defined by means of Faraday's law as the quantity which moves in electrolytes associated with 0.001118 g. of silver, or the equivalent quantity of another ion. This unit is called a Coulomb. With an equivalent proportion in grams of any ion, we have therefore associated $\frac{107.938}{0.001118} = 96540$ coulombs.

The unit of potential is so determined that one coulomb per second passes through a column of mercury of 1 sq. mm. section and 106.3 cm. long at 0° when the difference of potential between its ends is equal to unity. This unit is called a Volt.

A coulomb falling through one volt liberates energy equal to 10^7 ergs.

The practical definition of potential is based on the use of a normal element. Latimer Clark's cell, composed of

zinc, zinc sulphate, mercurous sulphate, mercury,

has a potential difference of $1.434 - 0.001(t - 15)$ volt between its electrodes.

A magnitude very frequently employed is the Ohm, the unit of resistance. It is defined practically as the resistance of a column of mercury 106.3 cm. long and 1 sq. mm. in section. Single resistances and sets of resistances made of German silver, which comply with this definition, may be purchased.

The ohm naturally depends on the two magnitudes above mentioned, the quantity of electricity, and the potential. The numerical relations are the result of a whole series of careful investigations by various physicists.

The unit of current strength, the Ampère, corresponds to a flow of one coulomb per second through the section of the conductor, or to a difference of potential of one volt between the ends of a resistance of one ohm. There is as yet no convenient practical definition of it. The relation to a tangent galvanometer of given radius cannot be carried out, as the deflection of the needle depends not only on the current strength, but also on the strength of the magnetic field in which the needle is situated. Now this, so far as it is dependent on the earth's magnetism, is variable from place to place, and in the laboratory the masses of iron everywhere present act in such an indeterminate fashion, that we must be content with relative determinations.

The Clark Element.—The production of normal elements of definite electromotive force is nowadays no difficult matter. The Clark cell is made most simply as follows:—

A glass cylinder 2 cm. wide and 6 cm. high is set in a wooden foot provided with two screw terminals. In the cylinder there is first of all a layer of pure mercury, then comes mercurous sulphate moistened with saturated zinc sulphate solution, and then a paste of zinc sulphate crystals with saturated zinc sulphate solution. Into this magma there projects a rod of amalgamated zinc, fastened into a paraffined cork, which is pressed in below the level of the edge of the tube and covered over with warmed marine glue or a mixture of wax and resin. A soldered-on copper wire connects the zinc rod with one of the binding screws, the other being connected with the mercury by means of a platinum wire passing through a glass tube also projecting downwards through the cork (Fig. 144). When the mercurous sulphate is rubbed up with the zinc sulphate, it is well to add a little mercury to reduce any mercuric salt which may be present. In filling the cylinder, attention must be paid to keep the upper part of the vessel clean, as the zinc sulphate will otherwise creep up the sides.

A few drops of paraffin oil poured on the zinc sulphate solution effectually prevents evaporation.

The usual care must be devoted to the purity of the materials, although slight impurities have no marked influence.¹ The zinc sulphate magma should be very thick, and at least two-thirds of the zinc rod should be surrounded by crystals of the salt. The whole soon crystallises to a solid mass, so that the element may be inverted without the mercury leaving its place. The zinc is covered with melted sealing-wax to within 1 cm. of its lower end.

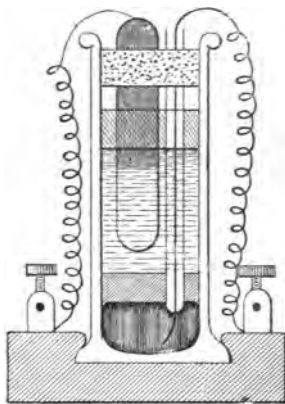

FIG. 144.

Such an element, when closed at 15° through a resistance of $n \times 106 \frac{\text{cm.}}{\text{mm.}^2}$ of mercury, deposits

$$1.4379 \times \frac{1}{n} \times 0.0011181 \text{ g.}$$

of silver per second, and has thus an electromotive force of 1.438 volt at 15° with respect to the "legal" ohm of 106 cm. The value 106.3 cm. is at present supposed to be more correct, the deposition of silver through this resistance being 0.3 % smaller, and consequently also the electromotive force. The temperature coefficient is 0.0010 volt. The electromotive force of the Clark element is thus—

$$1 \text{ Clark} = 1.4336 - 0.0010(t^\circ - 15) \text{ volt.}$$

The Clark elements recommended by the Imperial German Institute at Charlottenburg are somewhat differently arranged. They consist of an H-shaped vessel (first employed by Lord Rayleigh), the bottom of one side of which is covered with a layer of mercury, the other side containing an amalgam of 9 parts mercury and 1 part zinc (Fig. 145). The zinc amalgam is poured in when warm, and solidifies on cooling. The mercury is covered with a thick paste of mercurous sulphate, zinc sulphate, and mercury, rubbed up with a saturated zinc sulphate solution. On the top of this, and also on the top of the mercury, there come zinc sulphate crystals, the whole being then filled with saturated zinc sulphate solution to within 1 or 2 cm. of the top. The cell is closed by paraffin poured on when hot, a cork disc, and melted resin. For use the cell is set on a saddle-shaped support provided with binding screws. The electromotive force is 0.0002 volt smaller than that of the element described above.

The Clark cell suffers from the drawback that its electromotive

¹ Kahle, *Ztschr. f. Instrumentenkunde*, 12, 130, 1892.

force varies greatly with the temperature, and that the electromotive force corresponding to each temperature is only slowly attained. The element should therefore be made as small and narrow as possible in order to follow the changes of temperature rapidly. For very exact measurements it must be kept in a thermostat.

The electromotive force is diminished by strong currents; 0.001 amp. can be taken off for a short time, 0.0001 amp. for any length of time without causing a noticeable error. The cell soon recovers when the circuit is opened.

Other Normal Elements.—On account of its great temperature coefficient and temperature lag, attempts have been made to replace the Clark element by others. Favourable accounts have been given of Gouy's element,¹ which is composed as follows:—An amalgamated zinc rod is immersed in a 10 per cent solution of zinc sulphate (sp. gr. 1.06), which rests on a layer of mercury. Precipitated mercuric oxide acts as depolariser. The element may be put together in exactly the same way as the simple Clark cell (Fig. 144). The concentrated solution of zinc sulphate is boiled with a little silver oxide, and the filtered liquid set aside for a few days in the cold in contact with strips of zinc in order to precipitate the silver and any other foreign metals. The mercuric oxide is precipitated at 40° from an acid solution of mercuric sulphate by sodium carbonate free from chloride. Gouy states, however, that the oxide precipitated from mercuric chloride in the ordinary way may also be used.

The E.M.F. at 12° is 1.390 legal volts, or 1.386 true volts. The temperature coefficient is -0.0002 volt, so that the E.M.F. is

$$1 \text{ Gouy} = 1.386 - 0.0002(t - 12) \text{ V.}$$

Mechanical disturbance raises the E.M.F. slightly; but closing the cell for a few instants through a resistance of several thousand ohms restores it to the normal value. The zinc may be surrounded by a wide glass tube closed at the bottom and provided with a side opening of 0.5 mm. The resistance is thereby made very great, so that an accidental short circuit does no damage, and there is no danger of mercury getting to the zinc even on violent motion, which would spoil the element altogether.

We have finally to describe the construction of elements with exactly 1 volt tension, which for many purposes are very convenient. The electrodes again consist of amalgamated zinc and mercury, the latter being covered with calomel and a strong solution of zinc chloride (sp. gr. 1.409). The arrangement is shown in Fig.

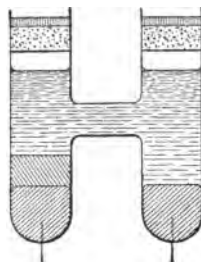

FIG. 145.

¹ *Jour. de Phys.*, 7, 532, 1888.

146. Zinc chloride is usually basic, so that hydrochloric acid should be added to the concentrated aqueous solution until the white deposit just dissolves. It is also well to let the solution stand for some days with zinc clippings to precipitate traces of cadmium, which are frequently present. In this way we obtain an E.M.F. of 1 volt \pm 0.01. A few days after the element has been made it is compared with a standard Clark or Gouy cell and its error determined. The E.M.F. rises when the zinc chloride is diluted, falls when it is made more concentrated; in this way we may correct the cell if we wish. The temperature coefficient is very small, not more than +0.00007 V. The cells remain constant for a very long time; I have had several in my possession for five years without their undergoing any noticeable change.



FIG. 146.

Sources of Current.—For all purposes requiring a weak current up to 0.1 amp. the manganese peroxide cells of Leclanché are the most convenient. They are to be obtained in various forms, those being best which admit of renewal of the peroxide, whether in the form of pressed cakes fastened to the carbon plate with rubber rings, or in the form of a mixture of fragments of peroxide and coke round the carbon plate. The sal-ammoniac solution should not be saturated; 20-25 % is a suitable strength. When much of the double zinc ammonium chloride has crystallised out, a little hydrochloric acid may be added to dissolve the crystals, but not too much, or else the zinc will also dissolve. The E.M.F. is 1.2 to 1.3 V., and remains very constant for a small current (a few hundredths of an ampère); it soon regains its original value even after strong currents have been taken off.

Accumulators should be employed for stronger and continuous currents, as they far surpass all other batteries in point of productiveness and convenience. Where there is an electrical installation, a battery of accumulators is usually found in connection with it. If there is no such installation an opportunity must be sought to get the accumulators charged in the neighbourhood.

Accumulators should never be allowed to run down completely, and should be used as regularly as possible. If they are not to be used for a long period (*e.g.* over vacations), they should previously be fully charged up.

It is not in general convenient to have in the laboratory a single large fixed battery with connections and switches for the various rooms. Such an installation, which does very well for a factory, where the same operations are repeated at the same places, is sooner or later found to be insufficient or inconvenient for laboratory purposes. I therefore consider it better to have the accumulators

movable, and to set up a fixed battery with the proper connections only for definite purposes, such as for driving a fixed motor, a large electromagnet, or the like.

Thermopiles, of which suitable forms are now to be obtained from the dealers, give very constant and long-continued currents of moderate strength—up to a few ampères. The chief difficulty with such piles lies in the danger of over-heating, the elements melting and the pile being destroyed. It is therefore best to interpose a gas-pressure regulator to prevent accidents of this sort.

For many purposes, small currents with a high potential are required. These are got by building up a battery of 100 or more single elements. Batteries of this kind may be made most cheaply on the plan of the Leclanché cell. Cylinders of moderate calibre (opodeldoc glasses) to the required number are set into a suitable frame of seasoned wood, and are half-filled with a mixture of peroxide and coke. In each glass there is inserted a carbon rod 3.5 mm. diameter, such as is used for arc lamps. Zinc rods with a soldered-on ignited copper wire are also provided, each wire being wrapped firmly round a carbon, and the zinc put into the next cell. A piece of cardboard prevents immediate contact between it and the carbon in the same cell. The glasses are then filled with a 20% ammonium chloride solution, and covered with a layer of mineral oil 1 cm. deep.

Connections, Keys, Binding Screws.—Copper wire is used almost exclusively for electrical connections, and is generally insulated with silk or gutta-percha. The thickness of the wire depends on the current, but it cannot be conveniently reduced below 0.3 mm., as the binding screws will not catch thinner wire.

When several wires are to be connected permanently, this is done by soldering, mostly with soft solder. The joints soon become loose if they come in contact with mercury, so that they should be varnished over at once to obviate this danger, which is always present.

Binding screws are used for making detachable connections, and occur in a great many forms. For small pieces of apparatus Ludwig's pattern, shown full-size in Fig. 147, is very useful. The transverse bore should be completely closed up when the screw is home, as otherwise thin wires are not caught properly.

For connections to be easily opened and closed, plugs are used in the manner adopted by Siemens for his resistance box. They are slightly conical pieces of metal, generally brass, and are set into similarly shaped holes in the various parts of the apparatus. They can be used in two ways: either an intervening plug connects two pieces (Fig. 148), or the plugs are provided with binding screws for the reception of wires, and are set into undivided holes (Fig. 149). The plugs are valuable on account of their very slight resistance,

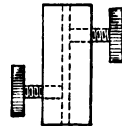

Fig. 147.

and can therefore be always employed where the resistance of the circuit is not to be altered.

Another sort of connection, practically without resistance, is

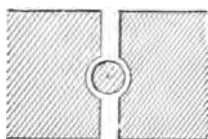

FIG. 148.

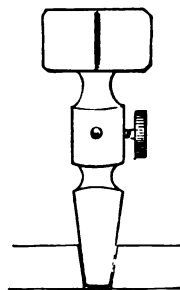

FIG. 149.

obtained by the employment of mercury. The conductors end in amalgamated copper wires, which are connected by placing two or more of them together in a mercury cup.

Mercury cups may be made of different materials. Where very good insulation is not required, we may bore in a piece of seasoned wood holes 0.6 to 1 cm. in diameter and rather more in depth, which are then half-filled with mercury. It is convenient to have the board with a small raised rim to catch any mercury that may be spilt. Good mercury cups can be made by boring holes in corks in the ordinary way and fastening them to a piece of wood with sealing-wax. If the ends of the conductors are soldered to pins, these may be stuck into the material of the cup, so that the ends of the connection cannot jump out of the mercury, as so often happens (Quincke). For this purpose it is well to use copper pins, as the zinc of brass pins is very soluble in mercury and makes it dirty, whereas copper is only dissolved in small quantity. Steel needles are much cleaner, but the contact is not so good; however, if copper is deposited on them electrolytically, they may be amalgamated and then give certain contact.

Useful mercury cups can also be made by fastening pieces of black india-rubber tubing 1 cm. long on wood or glass by means of sealing-wax. The side of the tube is bored through at several places beneath the mercury surface with an awl; surface tension prevents the mercury from running out of the holes, while the ends of wires can be conveniently stuck through them.

Several mercury cups can be arranged on the same board and connected by bridges of copper wire, many sorts of apparatus being made in this way. The one mostly in use is the rocker (Fig. 150), which consists of six cups which can be connected in pairs by two three-legged bridges insulated from each other. If the rocker is

lying as in the figure, 2 is connected with 3, and 5 with 6; if it is tilted over to the left, the connection is between 2 and 1, and 5 and 4.

The rocker in the form shown serves to connect a given circuit (e.g. of a galvanometer) alternately with two independent currents; the ends of the given circuit are then connected with 2 and 5, whilst the independent currents are brought to 1, 4, and 3, 6. It can also be used as a commutator to reverse a current, if 1, 6, and 4, 3, are connected by insulated wires. The cell terminals come to 2, 5, and the current is led off from 3, 6, or 1, 4. If the rocker is tilted to the right, the current entering at 2 goes to 3; but if it is tilted to the left, the current goes from 2 to 1, and thence to 6, whilst 5 is connected with 3 through 4.

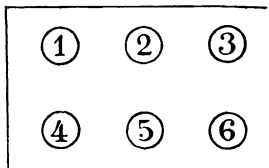
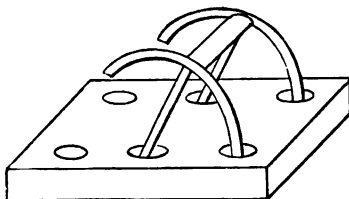

FIG. 150.

It is of importance when mercury connections are used, to work with the mercury cleanly and without loss. For this purpose we should use a bottle of 50 cc. capacity, closed by a cork with a glass tube bent over into a stout-walled capillary, as shown in Fig. 151. By inverting and turning the bottle, even small cups may be filled without the mercury splashing or spilling.

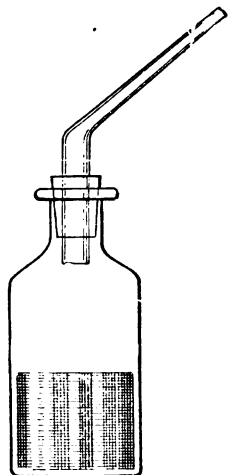

FIG. 151.

To get small quantities of mercury out of cracks and corners, a small mercury pipette of the form shown in Fig. 127, p. 178, may be used. It is well to make the lower tube rather narrow (0.2-0.3 cm. diam.) so that air will not be sucked up along with the mercury.

Plugs and mercury cups may also be used to make and break currents, but keys of various forms are usually employed for this purpose.

A cheap, convenient, and reliable key for electrical connections may be made as follows:—Two longish strips of brass are fastened down to a small board by means of a binding screw and a counter-sunk screw-nail—one of them directly, the other through a wooden support a few millimetres thick in such a way that it projects about 1 cm. over the first strip

(Fig. 152). A screw is inserted into the projecting portion, and by screwing up makes the current, whilst screwing back breaks it.

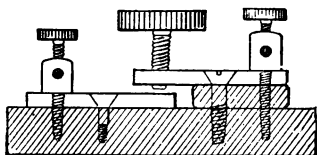

FIG. 152.

Platinum contacts are not necessary, as the screwing motion keeps the surfaces clean. The principle of screw contacts is capable of wide application, and can be used almost everywhere with advantage instead of plugs, as there are no loose parts to get lost or spoiled.

For closing the circuit momentarily, a key, such as is shown in Fig. 153, is employed. A strip of brass 8-10 cm. long, 1 cm. wide, and 0.1 cm. thick, is bent, as in the figure, and fastened with a binding screw and a nail to a small piece of board. A screw with an insulating ebonite head passes through the free end, its position being fixed by a nut. A second strip of brass, also with a binding screw, lies beneath the end of the first. To obtain better contact, the filed-

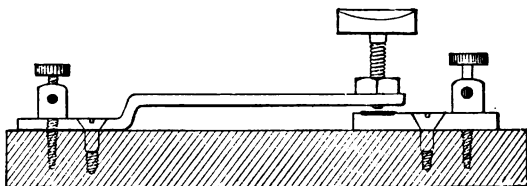

FIG. 153.

off point of the screw and the surface opposite it may be faced with platinum. The contact screw is placed so that it stands only a fraction of a millimetre off the plate, a very gentle pressure being thus sufficient to make connection. If the key spring is too stiff, it may be made easier by filing down in the neighbourhood of the bend.

Such keys are used especially in connection with the galvanometer and electrometer. They are placed so that they lie conveniently to the hand, and may be found without looking.

Galvanometers.—The galvanometer is the most common of all electrical measuring instruments, and is now made in so many different forms that a description of them cannot find a place here. When one is bought, it should be seen that interchangeable coils of different wire are provided, that observations in every azimuth are possible by the mirror and mirror-case being movable, and that the suspending thread is not too long. To diminish the torsion, the thread is often made too long, especially in Germany, which leads to a very inconvenient instability and sensitiveness to mechanical disturbance. It is not necessary to exceed 10 cm., and with quartz filaments 5 cm. is sufficient, in most cases even less.

The galvanometer is read with an index and scale, or by means of a reflected beam of light on a scale, or finally with telescope and scale.

Index readings are usually made only with comparatively rough instruments. Their sensibility is proportional to the length of the pointer, and can be increased by optical magnification. Very light and rigid pointers may be made by drawing out thin-walled glass tubes; at the tip the tube is again drawn out after careful warming, so that a needle-point is left, which must be blackened. The point can also be made of a black hair drawn from a water-colour brush and fastened into the end of the glass tube with a little shellac varnish. In this way the fineness of the reading may be carried pretty far, but it scarcely repays the trouble, as the necessary proximity of the observer, who is almost always magnetic, influences the position of the magnetic needle.

The reading by means of an illuminated image is either made by having the mirror a concave one of long focus, 50-100 cm., or if it is plane, by producing the image by means of a lens and interposing the mirror in the path of the beam. This method has the advantage of being very convenient, and may be carried out with very simple optical appliances, but it is not so exact as the reading with telescope and scale.

The method of using galvanometers with plane mirrors will first be described, as they are the most common variety. A paraffin lamp, capable of moving up and down on its stand, is provided with a thin brass cylinder, which is lined with asbestos paper, and placed over the glass cylinder of the lamp in such a way that it cuts off most of the light, without interfering with the supply of air. At the spot where the flame is brightest, a round hole 1-2 cm. in diameter is cut out of the cylinder, and a thin wire soldered across it vertically. A lens of 50 cm. focal length (a spectacle glass will do) throws the light on the mirror, which is about 1 m. from the lamp. A millimetre scale is placed in the path of the reflected beam, and the lens is moved backwards and forwards until a well-defined image of the wire appears on the scale.

The reading is sharper when a concave mirror is employed instead of a plane one. Convex spectacle glasses of 2-4 m. focal length may be used in this case also by silvering and varnishing the side farthest from the lamp. The glasses should be selected as thin as possible on account of the moment of inertia.¹

Quincke¹ arranges the apparatus so that the lamp carries the scale, by covering it with a box, 12 × 10 cm. section and 26 cm. high, which has an opening at the back for observing the lamp, and a slit 0·8 cm. broad and 4 cm. high in front at the level of the flame; above this slit there are two hooks for suspending a paper scale attached to a lath.

¹ Quincke, *Wied. Ann.*, **48**, 28, 1893.

The method of reading with telescope and scale is well known. In setting up the apparatus, the galvanometer is first put in order, the coils placed parallel to the compass needle, and the mirror perpendicular to the axis of the telescope. The eye is next brought to the telescope, and the scale moved to the proper height, at which it is then clamped. The telescope is now focussed on the mirror, the eye-piece being drawn out until the mirror is seen clearly. If the eye-piece is now pushed in, the image of the scale is either in the field of vision, or is brought into it by a slight movement of the scale, the fine adjustment being made with the eye-piece.

The best arrangement with respect to a window in daylight is shown in Fig. 154.

For evening work a horizontal parabolic cylindrical reflector bent out of thin sheet nickel will be found convenient, two holes being provided for the lamp-glass. It is placed so that the scale is illuminated as uniformly as possible, and the eye is protected from the light by screens of thick, dark cardboard hung over the telescope.

The distance from which the observation is made depends chiefly on the magnifying power of the telescope; one or two metres is the most usual. A great deal depends on the quality of the mirror, especially with high powers. If microscope cover-glasses are used, small pieces (less than 5 mm. side) should be taken, and a great many of them silvered, the most suitable being then selected. Good and very thin mirrors can now be purchased. In fastening them one must be careful not to bend them by irregular pressure. Cementing the magnet on to

the back often spoils them; it is better to catch them at three places in a light frame. Mirrors made of somewhat stouter glass do not require the exercise of such care.

Electrometers. — The most suitable electrometer for physico-chemical purposes is Lippmann's, especially in its simpler forms. It is small, only slightly sensitive to mechanical, almost indifferent to electric, and completely indifferent to magnetic disturbances. Its somewhat large capacity is of little moment in electrochemical work.

The electrometer is based on the fact that the surface tension of mercury in contact with an electrolyte (dilute sulphuric acid) changes when the difference of potential at the point of contact changes. It consists of two quantities of mercury connected through sulphuric

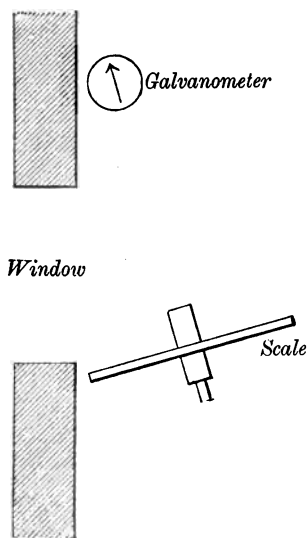

FIG. 154.

acid. One of the quantities has a large surface of contact with the acid, the other a very small one; and when a difference of potential is brought between the two, it distributes itself in the ratio of the surfaces of the two electrodes, *i.e.* it affects the small electrode almost exclusively. Now, if this small electrode is so arranged as to assume a definite position of equilibrium under the influence of surface tension, the introduction of a difference of potential will change this position of equilibrium, and there will result a movement of the mercury which serves to measure the magnitude of the difference of potential.

The deflections obtained in this way can only be assumed to be proportional to the potentials within very narrow limits (0·1 V. at most). The mercury of the small electrode should suffer principally cathodic polarisation, and so should be connected with the zinc end of the element; the polarisation, too, should not exceed 1 V. Anodic polarisation must not proceed beyond a few hundredths of a volt, for otherwise the mercury becomes impure and the meniscus loses its mobility. Should this have happened unintentionally, a drop of mercury must be forced out of the tube, so that a fresh mercury surface may be formed. Too strong cathodic polarisation causes the formation of small bubbles of hydrogen, which are removed in the same way.

The most convenient form for the laboratory is sketched in Fig. 155. A thin strip of wood is fastened to one end of a board by an

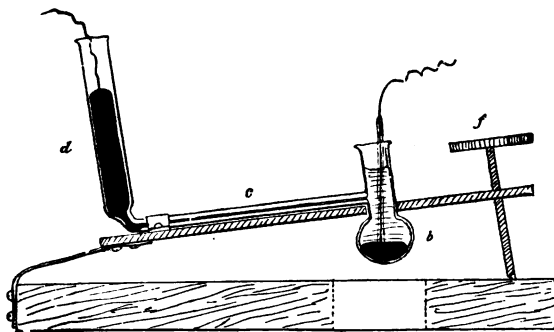

FIG. 155.

elastic metal band, and can be made to form any angle with the horizontal by means of a screw *f*. To this strip the glass apparatus shown in the figure ($\frac{2}{3}$ natural size) is attached. The capillary *c* is about 0·5 mm. bore, and below it there lies a scale divided into half millimètres. Mercury is first placed in *d* and *b*, and then dilute sulphuric acid (1 : 6 by volume) is poured into *b*. Platinum wires lead from the two masses of mercury, the wire in *b* being protected from contact with the sulphuric acid by a glass capillary fused over it. The wires lead to two screw terminals not shown in the figure. To

set the electrometer in action, the two screws are first connected by a wire, a drop of mercury is allowed to pass from *d* to *b*, the apparatus is inclined backwards so that a portion of the capillary is filled with sulphuric acid, and the levelling screw *f* manipulated until the mercury thread comes near the end of the capillary. The more inclined the capillary is, the less sensitive is the electrometer, but the adjustment is the more rapid. By removal or addition of mercury to *d*, the sensitivity can be further regulated; a deflection of 3 to 5 scale-divisions for 0.01 V. appears to be most convenient. Finally, a lens is so attached that the position of the mercury thread on the scale beneath it can easily be read off. A broken thermometer scale will do in case of necessity, and the tenths or fifths may be estimated.

These instruments cost practically nothing, can be put together in a few minutes, and are accurate to 0.001 V. They are not used as measuring instruments proper, unless in exceptional cases, but as zero instruments with a compensation method.

As the capillary electrometer keeps permanently in order only when its circuit is closed, except at the moment of measurement, a key, such as is shown in Fig. 156, must always be attached. A strip

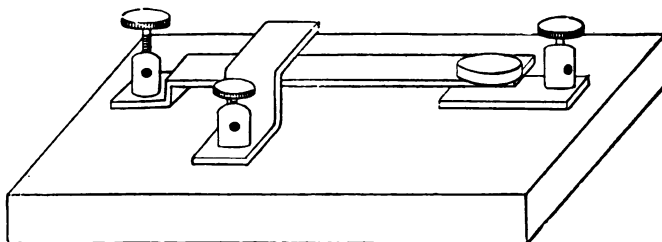

FIG. 156.

of brass is provided at one end with an insulating button, and on being pressed down connects the left-hand terminal with the right-hand one. In the position of rest it presses upwards against a projecting piece of brass to which the middle terminal is attached, so that the latter is connected with the left-hand terminal, the connection being broken only immediately before the right-hand one is touched. The mercury in *b* is connected with the middle, that in *d* with the left-hand terminal, and the potential to be measured with the right-hand terminal.

A second form of capillary electrometer of somewhat greater sensibility (5 to 10 scale-divisions for 0.001 V.) can be constructed by making the capillary vertical. The necessary glass apparatus has the form of Fig. 157. The deflection is much smaller on account of the vertical position of the capillary, but the adjustment is much more rapid. The reading must now be done by means of a microscope magnifying 20 to 40 diameters, such as can be bought at an optician's for a

few shillings; the scale is in the eye-piece, and has its divisions about 0.2 mm. apart (cf. p. 24).

The electrometer and microscope are attached in such a way that the former has a small vertical motion, and the latter a motion in the direction of its axis, the capillary passing through the middle of the field of vision. For this purpose a shallow groove is filed out in the top of a brass rod, and a slit brass collar soldered on to hold the microscope. A hole is then bored through the rod at right angles to the microscope axis to allow free passage to a wire, bent twice at right angles, which supports the electrometer. A screw holds it fast in position, and in order that it may not rotate by the weight of the electrometer, the side on which the screw acts is filed flat. A soldered-on slit brass collar holds the glass part of the electrometer. Fig. 158 shows the arrangement half the natural size.

A mirror with universal motion throws the light through the electrometer into the microscope, and permits accurate reading. The mechanism consists of cork and wire fastened together, as in Fig. 159,

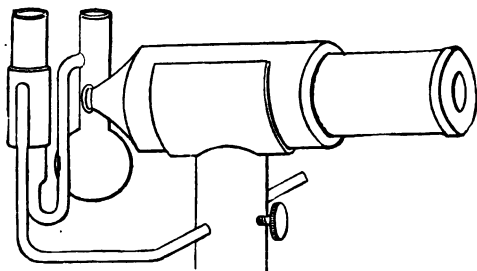

FIG. 158.

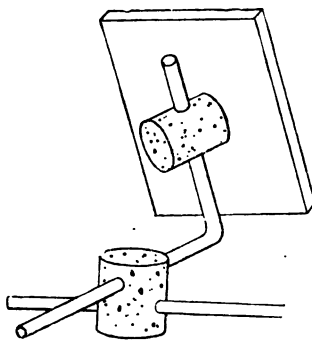

FIG. 159.

where the back of the mirror is shown. The support of the mirror also passes through a hole in the standard and is held in position by a screw. The whole is made movable vertically on a stand so as to get the eye-piece of the microscope at a convenient height for the eye.

Two insulated terminals are attached to the foot of the stand, and are connected with the two portions of mercury in the electrometer by means of platinum wires. If one of the wires passes through the sulphuric acid, it must be fused into a glass tube at that part. The most sensitive of all the forms of the Lippmann electrometer is the one with a conical capillary first constructed by the inventor. The

apparatus is made much more convenient by constructing it of moderate height, 30-40 cm., and may be made easily as follows:—

A clean glass test-tube about 8 cm. long has a platinum wire sealed into it, and is set into a suitable opening in a board (Fig. 160).

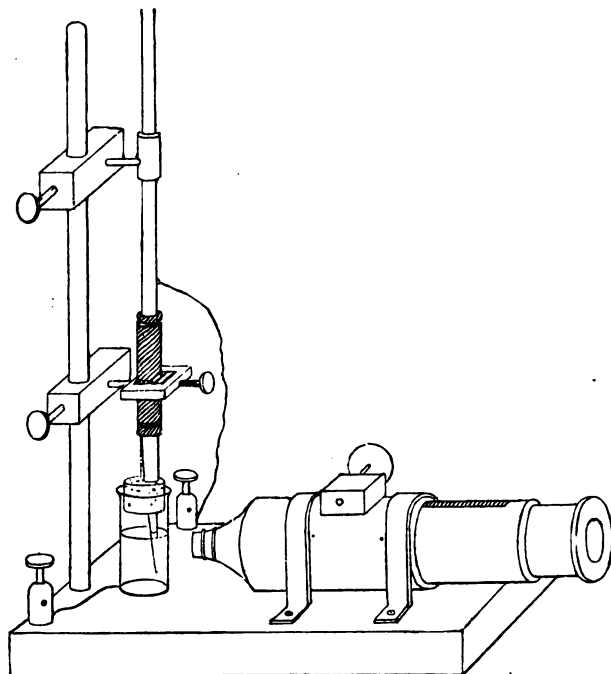

FIG. 160.

The microscope is fastened in front of the test-tube so that the two axes intersect. The capillary is made by drawing out stout thermometer tubing of about 1 mm. bore; according as a greater or smaller sensibility is desired the part between *b* and *c*, or between *a* and *b*, is made use of (Fig. 161). When the tube is drawn out, it should be softened until it has almost run together, and then the two ends are pulled apart, not too rapidly, with a steady motion.

The capillary passes through a paraffined cork with a slit in the side (so as to avoid an air-tight connection), by means of which it can be set into the test-tube. The part of the capillary to be observed in the microscope is brought forward until it lies against the front wall of the tube. The upper portion of the capillary is connected with a black rubber tube 5 cm. long, which is fastened on very carefully, best by means of covered copper wire. A screw clip is then passed over it, and into it there is wired the pressure tube, 30 or 40 cm.

long, and 0.5 cm. wide. The pressure tube has a platinum wire sealed into it, and also a short side tube, which is closed by a rubber tube and clip or by a tap (not shown in the figure), and is carried by a clamp moving on a rod screwed into the foot. The platinum wires from the pressure tube and the test-tube end in screw terminals insulated by means of gutta-percha and also attached to the foot. The illuminating mirror must also be fixed on.

To set the apparatus in action, the bottom of the test-tube is covered with pure mercury, and the tube is then filled to three-fourths of its height with 1:6 sulphuric acid. The capillary and pressure tube are next placed in position, and fixed, along with the screw clip, to the stand. The screw clip is then closed, and the pressure tube filled with mercury. By carefully opening the clip the mercury is allowed to enter the capillary, so that no air-bubbles interrupt the mercury thread.

Next comes the most difficult operation, filling the capillary with mercury. The two platinum wires are connected with the terminals, and these with each other by means of a wire, so that the electrometer forms a closed circuit; the clip is screwed tight, and the part of the rubber tube lying between the clip and the capillary is pressed together between the fingers. A considerable pressure can be exerted in this way, and the mercury with which the rubber tube is filled is easily pressed through the capillary. When the pressure is relieved, sulphuric acid enters the capillary from the test-tube.

If the operation has succeeded, the clip is again opened, and it is observed whether mercury escapes from the capillary or not. If it does, mercury is allowed to flow out of the side tube until, in consequence of the diminished pressure, the escape ceases, and sulphuric acid enters the capillary. By a slight rotation of the cork, or the test-tube, the capillary is brought into the field of the microscope, and the pressure is so regulated (the screw clip being used for this purpose) that the meniscus appears at the middle division of the ocular micrometer. The lower portion of the capillary containing sulphuric acid should be made as short as possible, as the rate of adjustment depends on this.

If the mercury does not escape even when the pressure tube is quite full, the capillary is too narrow. The position of the meniscus is found with a lens, and the capillary cut off at that place, the regulation being then made as before.

In order to be able to move the mercury easily, a long rubber tube is attached to the top of the pressure tube so that one can blow or suck with the mouth while the eye is applied to the microscope. The electrometer moves regularly only when the capillary is well



FIG. 161.

wetted with sulphuric acid, and after a long period of repose the mercury must be drawn up into the capillary by suction in order that good readings may be obtained.

The original zero of the instrument changes slowly during the first few days, but afterwards it is very constant. It may be brought to the zero of the scale by a slight movement of the screw clip.

The microscope should magnify 50 to 100 diameters, and the micrometer scale have about 30 divisions in the field. A sharp image is obtained only when the capillary lies close against the test-tube wall.

At first I adopted Lippmann's arrangement of providing the electrometer with a manometer, the potential being determined by ascertaining the pressure necessary to bring back the meniscus to its original position, but I have given it up completely on account of the frequent necessity of re-determining the relation between the pressure and the potential, and now use the electrometer entirely as a zero instrument to detect the absence of potential differences on compensation, and to measure any small differences remaining. For the last purpose, the scale of the micrometer is sufficient.

The considerably greater difficulty in constructing this last form is repaid by an increase of sensibility, which, according to the capillary, may amount to 10 or 100 times that of the simple form of the instrument. Usually we have a deflection of 3 to 10 divisions for 0.001 V., and can therefore observe 0.0001 V. securely and estimate down to 0.00001 V. The capillary must, however, be very good before such accuracy is attained. If necessary, a dozen capillaries should be made, and the best among them selected.

Thomson's Quadrant Electrometer.—The setting up of this instrument is quite similar to the setting up of a galvanometer, and the observation may be made either objectively with a concave mirror or lens, or subjectively with the telescope. Care must be taken to have the needle symmetrical with respect to the quadrants, so that the deflections on right and left are equal on reversal.

The needle is usually connected with the potential to be measured, whilst the quadrants over the cross are charged equally positive and negative. The charging is best done with a galvanic battery of 50 to 100 elements.

Of the well-known forms of battery, Rowland's is the handiest.¹ Strips of copper and zinc foil 4.5 cm. broad are soldered together lengthwise and then cut crosswise into pieces 0.5 cm. broad. These pieces are bent into the form of a U, with one limb zinc and the other limb copper. A glass plate of suitable size is now coated thickly with shellac, and the bent pieces warmed at the bend and set in series in the shellac so that the zinc of one pair and the copper of the next are about 1.2 mm. apart. After all the elements are in position, the

¹ *Phil. Mag.* [5], 23, 303, 1887.

plate is again warmed gently and covered with a thick coat of wax and resin to hold the couples firmly.

To set the battery in action, it is dipped 1 cm. deep into water with the elements downwards, and then removed, whereby a drop of water hangs between each zinc-copper couple.

It is safer to put a small piece of porous paper between the pairs, more water being held in this way, and metallic contact as well as interruption of the circuit by the falling off of a drop being avoided.

The sensibility of a quadrant electrometer is usually 0.01 V., and can be increased to 0.001 V. For the purposes of physical chemistry it may almost always be replaced by the galvanometer or a Lippmann electrometer.

Measurement of E.M.F.—Since the deflection of a galvanometer with a given resistance is within certain limits proportional to the E.M.F., it is possible to determine the latter by simply observing the deflection with telescope and scale, and comparing it with that caused by a standard element immediately before or after. To nullify the effect of differences in the resistance, as sensitive a galvanometer as possible is taken, and resistances put in until the deflection becomes of a convenient magnitude. The large resistances necessary for this purpose (ca. 1 megohm = 10^6 ohm) are obtained by drawing lines with graphite on a ground glass surface.

If the resistance of the cell to be measured cannot be neglected, it is put in the circuit with the standard element, first in series with it, and afterwards opposed to it. If π is the E.M.F. to be measured, π_0 that of the standard cell, and a and b the two deflections, then $\pi + \pi_0 = a$ and $\pi - \pi_0 = b$, whence

$$\pi = \pi_0 \frac{a + b}{a - b}.$$

Another process, which is perfectly independent of resistances, consists in connecting a condenser with the E.M.F. to be measured, and discharging it through the galvanometer. The galvanometer should be damped as little as possible, and its first deflection read off, for we have here to do, not with a continuous current, but with a single discharge. The disconnecting of the condenser from the cell and the connecting with the galvanometer must be done very rapidly; the galvanometer circuit, too, should only be closed for a moment in order to avoid the influence of the residue. This method likewise necessitates the employment of a sensitive galvanometer.

The measurement of E.M.F. by means of electrometers is also independent of the resistance. Hankel's electrometer is only moderately sensitive, but has a very small capacity. Thomson's electrometer may be made very sensitive, but the most sensitive of all is Lippmann's, the capacity of which, however, is considerable,

being of the order of a microfarad. With the first-named electrometers, the deflection of a standard cell is compared with that given by the cell under investigation, after the proportionality between deflection and E.M.F. has been thoroughly established. Lippmann's electrometer must be calibrated, as the proportionality between the E.M.F. and the pressure necessary for the adjustment of the mercury subsists only within very narrow limits.

Very much more convenient than the methods above described are those in which the measurement of E.M.F. is reduced to measurement of resistance. The principle of these methods was given by Poggendorff in his compensation method. Against the E.M.F. to be measured there is set a variable E.M.F., which is altered until the two cancel each other. The compensation may be indicated either by a galvanometer or by an electrometer.

The scheme for the arrangement is shown in Fig. 162. E is a

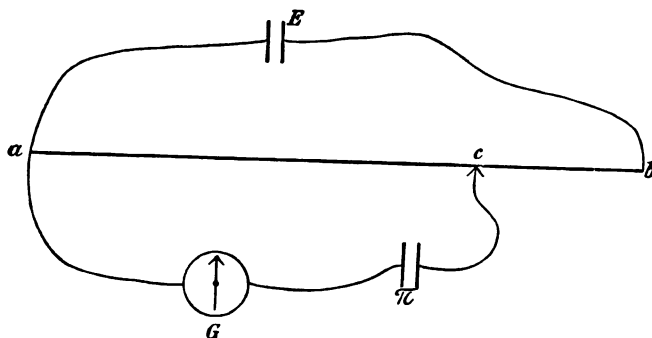

FIG. 162

constant element whose E.M.F. must be greater than that to be measured, and which is closed through the resistance ab . The element under investigation π is connected through a galvanometer or electrometer with a ; a movable contact c is moved along the resistance ab until the instrument indicates zero. A repetition of the process with a standard element gives the desired value, as the E.M.F. of the cell π is to that of the standard π_0 as the resistance ac is to ac_0 , the values for which compensation takes place. The process is based on the circumstance that the potential, setting out from a as zero, rises to b proportionally to the fraction ac of the whole resistance; consequently if $\pi < E$ there will always be found between a and b a value of the potential which is equal to π .

The resistance ab can be produced in many ways. It must amount to at least several hundred ohms in order that the cell E closed through it may retain its E.M.F. unaltered as long as possible. At the present time I know of no material which can be made into

cylindrical or prismatic rods at least 50 cm. long which would have a sufficiently uniform resistance amounting to a few thousand ohms or more. Such a material would offer the simplest solution of the problem, as it would merely have to be provided with a scale and a sliding contact to form a suitable apparatus.

I use the following arrangement in my laboratory:¹—Two terminals and twenty-one brass pegs 0.4 cm. diameter and 3 cm. long are screwed into an ebonite plate. The terminals *a* and *b* are connected with the pegs next them by means of stout copper wires soldered to both; the pegs marked 0 in Fig. 163 are similarly connected with each other. This is done on the under side of the plate, through which they project about 1 cm. There are now soldered in between the pegs 9 resistances of 100 ohms each on the one hand, and 10 of 10 ohms each on the other, the whole being then screwed on to a box to protect the wires from injury. The numbers are then written alongside of the pegs, as shown in the figure, thus indicating the resistances reckoned from the zero pegs.

Two tubular caps, slit open to make them elastic, fit on to the pegs, and are provided with ebonite tops and small binding screws for the attachment of wires.

A Leclanché cell is closed through the total resistance of 1000 ohms, together with an additional resistance of 250 or 300 ohms, the magnitude of which is so chosen that there is exactly 1 V. difference of potential between the terminals *a* and *b*; this being most conveniently determined with the help of a one-volt element (p. 195). If the caps are fitted on the zero pegs there is no difference of potential between them. Every step on the left-hand side gives a rise of potential equal to 0.01 V., every step of the other cap on the right-hand side gives a rise of 0.1 V. We are thus in a position to produce any potential between 0 and 1 V. in gradations of 0.01 V., and employ it in the compensation.

The subdivisions of 0.01 V. are determined as in the case of the balance, the deflections of the galvanometer or electrometer being read off for two positions of the caps, differing from each by 0.01 V., and having the desired value between them. For most purposes an estimation to a tenth, *i.e.* to 0.001 V., is sufficient.

To measure potentials over 1 V., one cap (or both) is connected with a small battery of five or more one-volt elements, which are arranged on a board with the pegs *a* to *g* in the manner indicated in Fig. 164. The pegs *f* and *g* are connected with each other, and with

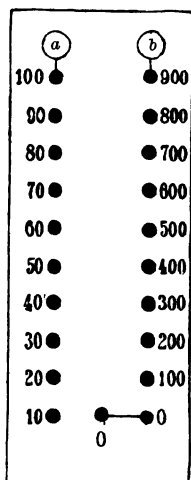

FIG. 163.

¹ *Zeit. physikal. Chem.*, 1, 403, 1887.

the zinc of the last element ; the platinum is connected as well as the wire coming from the zinc of the second element to the peg *e*, and

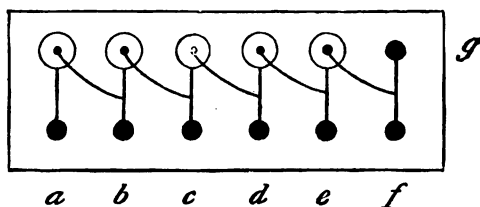

FIG. 164.

so forth. Two caps are used for tapping off the potential in this case also. If the caps are on *f* and *g*, the battery is out of the circuit, *e* and *f* give 1 V., *d* and *f* 2 V., and so on. Each element can be set against the whole poten-

tial of the resistance of Fig. 163, so that the E.M.F. at the terminals can be made equal to 1 V., and on the other hand the elements can be compared with each other. The whole apparatus is thus controllable in itself.

The forms of electrometer I use are those on Lippmann's principle, which have been described on pp. 202-208.

All the connections of the "compensation electrometer" are shown in Fig. 165. The Leclanché cell *L*, with the accessory resistance *W*, sends its current through the resistance box *R* of 9×100 and 10×10 ohms. The movable cap *a* is connected with the cap *c* of the one-volt battery, the other cap of which *d* leads to the cell π under investigation, whose second pole is led off to earth. The earth conductor is also connected with the electrometer and the middle terminal of the electrometer key *K*, the chief terminal of which is connected with the other portion of the electrometer, the contact plate finally being connected with the cap *b*. On pressing the button of the key, the circuit *Ebacd π E* is closed, and the electrometer indicates if π is compensated by the difference of potential *ab* (plus *cd* if need be), or not.

If potential differences smaller than 0.001 V. are to be measured, then by introducing graphite resistances of 9000 (or 99000) ohms, the gradations of the scale of potential (Fig. 163) are reduced to a tenth (or a hundredth), so that 0.0001 V. (or 0.00001 V.) can be measured. Lippmann's electrometer in the original form suffices to indicate with the first resistance, but with the second (which will scarcely ever be used) a very sensitive galvanometer must be employed.

In these cases, however, it is better to resort to the original form of a wire with a sliding contact. A manganin wire 0.01 cm. diameter has a resistance of ca. 50 ohms per metre. If it is stretched on a metre measure, and 12 metres of the same wire are added, then a Leclanché element, whose E.M.F. in these circumstances remains constant at 1.3 V., will give very nearly 0.1 V. for the whole length of the stretched wire, and consequently 0.0001 V. for each

millimetre; as tenths can still be estimated, we have 0.00001 V. as the limit of measurement. To obtain as near an approach to con-

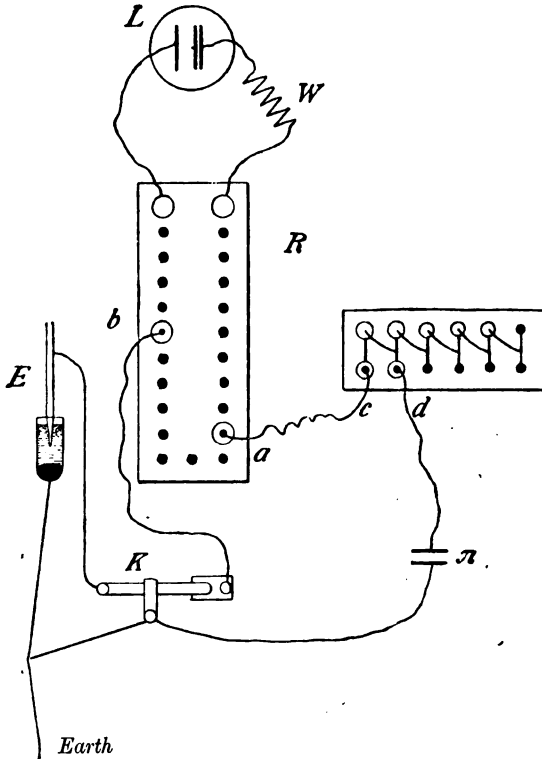

FIG. 165.

stancy as possible with Leclanché cells, several of them may be placed in parallel circuit, so that each only delivers a fraction of the current of 0.002 amp., but as far as my experience goes, this is scarcely necessary.

The same end may be secured by placing two similar resistance boxes R_1 and R_2 (Fig. 166) in parallel circuit, and sending the current of the stationary element through them. If all the plugs are taken out of R_2 and those of R_1 remain in position, the whole fall of potential takes place in R_2 , and the potential in π is zero. If now plugs are taken out of R_2 , and put into the corresponding positions of R_1 , the potential π is to the total potential π_0 as the resistance r introduced into R_1 is to the total resistance R , and we can, within the gradations of the resistance box, move any fraction of π_0 towards π . It is the same principle as in the case of the stretched wire with

sliding contact, and necessitates the constancy of the total resistance of the circuit.

Potential Differences.—The differences of potential of galvanically active combinations are additively composed of as many terms as there are contacts of different substances. The sudden changes of potential between metals are trifling, being only a few millivolts. Between solutions they are somewhat greater,

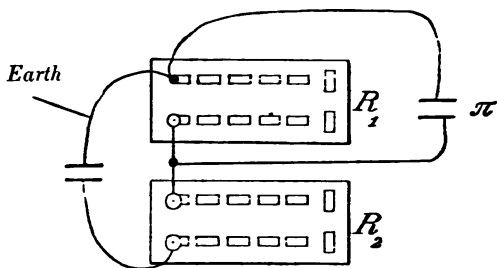

FIG. 166.

but they may be kept within narrow limits if such electrolytes are chosen as have ions with speeds of migration as nearly as possible equal, and if dilute solutions are used, especially when they are of equimolecular concentration. The greatest changes of potential are found at the contact of a metal with an electrolyte.

As these potential differences depend not only on the nature of the metal, but on the concentration of the ions of the same metal in the electrolyte, care must be taken that this concentration is a determinate one, for otherwise the value is badly defined. For example, we can scarcely talk of a definite potential difference between zinc and dilute sulphuric acid, for this depends on how many zinc ions are present in the solution. Immediately after immersion, some zinc dissolves, whatever the conditions may be, but the amount depends on accidental circumstances, and consequently the difference of potential varies between limits more or less wide.

Besides, the state of the metallic surface has frequently a considerable influence on the observed E.M.F. If it is at all practicable, it is best to use the metal in the form of a liquid amalgam, for then the state of the surface is quite well defined. The amalgams may either be prepared directly by dissolving the metal in mercury, or, what is in many cases more convenient, by passing a current through a solution containing the metal as a salt, the cathode being mercury and the anode a platinum wire. From measurements of the strength and duration of this current the quantity of metal deposited may be calculated by Faraday's law. The E.M.F. of amalgams is only very slightly different from that of the pure dissolved metal, but changes slightly with the strength, so that the concentration of the amalgam should always be stated.

If the metals are to be used as such, the arrangement in Fig. 167 is convenient. Tubes 1-2 cm. wide are drawn out and cut off, the narrow end being closed by macerated paper (filter-paper shaken up with

water). The electrolyte is poured into the tube, and the electrode in the form of wire gauze immersed in it by means of a cork. The solution permeates the paper plug, and by dipping this end into a conducting liquid, any sort of connection may be made without fear of the contents being contaminated with impurities. Fig. 167 shows how two such half-elements can be connected with each other through a watch-glass containing a conducting liquid.

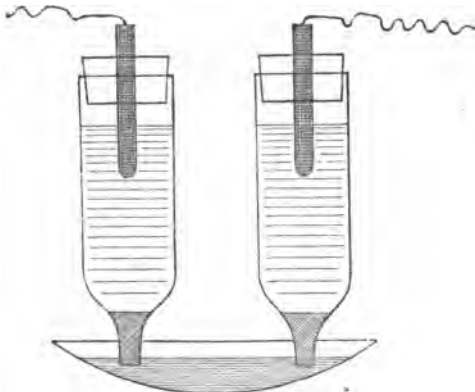

FIG. 167.

Of course, such combinations can be made in many other ways. Cotton wicks, saturated with the electrolyte, are often useful for conducting off and for making connections. Too long and narrow liquid conductors should, however, be avoided, as, on account of the very great resistance, the capillary electrometer becomes slower in action, and owing to the shunts always present, less sensitive.

Normal Electrodes.—To measure a difference of potential between an electrode and an electrolyte, at least one electrode more, and usually also another electrolyte, must be added to make the metallic contact with the electrometer. It is therefore best always to use the same accessory or standard electrode in order to remove any indefiniteness from the observed results. This is also necessary in investigating variable differences of potential (*e.g.* in polarisation), as otherwise it is impossible to determine which of the two polarised electrodes experiences the variation.

As a standard electrode, amalgamated zinc in a concentrated solution of zinc sulphate has hitherto been mostly used, but for several reasons this choice is not a very good one. Of late I have used in my laboratory mercury-calomel electrodes of the form shown in Fig. 168, and these have proved of great service both from their uniformity and wide applicability.

Pure mercury is poured on the bottom of a bottle, and above it there is placed a layer of calomel, and then a normal solution of potassium chloride. A rubber stopper bearing two tubes closes the completely filled bottle. One of the tubes is straight and is provided at the end with a short sealed-in platinum wire; if a drop of mercury and a conducting wire are introduced, connection is made with the mercury in the bottle without any fear of impurity. The other tube

is bent at right angles, and to it is attached a rubber tube 10 cm. long, which is provided at the other end with a bent glass tube, the

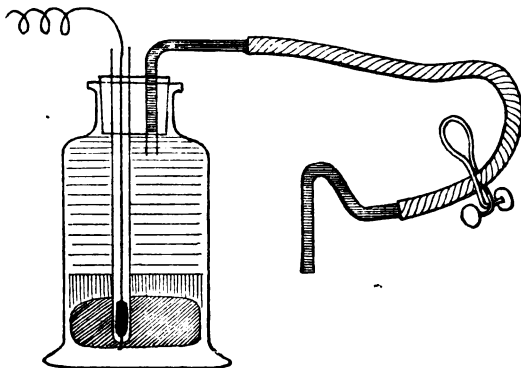

FIG. 168.

whole being filled with the potassium chloride solution. This electrode is connected with the electrolyte under investigation by means of the bent tube, and with the electrometer by means of the straight tube. The clip serves to prevent evaporation and contamination by diffusion when the electrode is not in use.

The difference of potential between the mercury and potassium chloride is, as far as we know at present, equal to 0.560 V., the mercury being positive, and the potassium chloride negative. This amount, regard being paid to the sign, is deducted from the total difference of potential measured, in order to obtain the value at the other electrode. For instance, if zinc in zinc sulphate when connected with the calomel electrode give a difference of potential of 1.10 V., it is to be concluded that there exists a potential difference of $1.10 - 0.56 = 0.54$ V. between zinc and zinc sulphate, the latter being positive with respect to the zinc by this amount.

Resistance—Wheatstone's Bridge.—For most determinations of resistance the arrangement given by Wheatstone is the most convenient. It consists of four resistances, $abcd$, which are put into the circuit in two parallel pairs, and connected crosswise by the galvanometer G . If $a/b = c/d$ no current passes through G . Circumstances are most favourable when all branches have the same resistance.

If a is made equal to nc , then $b = nd$.

There are many variations in the practical construction of a Wheatstone bridge. For general purposes, *e.g.* the production of wire resistances, there are placed at a and c interchangeable resistances of 1, 10, or 100 ohms; at b there is a resistance box, and at d the resistance to be measured. The plugs in the resistance box are

arranged until the galvanometer shows no current. By using the possible ratios of the other resistances 1, 10, 100, 0.1, 0.01, the range of the resistance box can be increased or diminished a hundredfold.

In the branch containing the battery (a Leclanché cell) there is a simple spring contact (Fig. 153), by means of which the current is made only for the moment during which the galvanometer is observed. If the resistance to be measured is not known approximately, so that the bridge is possibly quite wrongly arranged at the beginning, it is well to make the galvanometer insensitive by introducing a shunt before it. After approximate adjustment has been reached the shunt is removed and the measurement completed with the sensitive galvanometer.

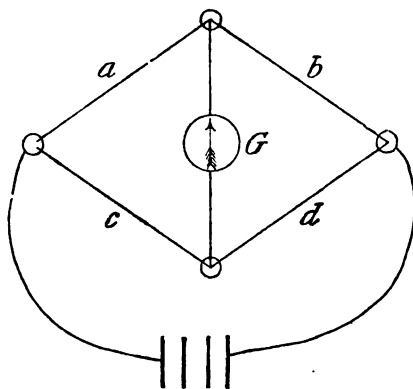

FIG. 169.

The connections between the different resistances of the bridge must be themselves free from resistance; on the other hand, a bad contact of the galvanometer or battery wires only influences the sensibility, and not the accuracy of the adjustment. When sliding contacts are used, they are consequently always placed at the end of the galvanometer or battery wires, and never at the connections of the resistances with each other.

The most secure contacts are mercury cups, then come plugs, such as were made by W. Siemens for his resistance boxes, and are now universally employed; binding screws are less secure. Attention must always be paid to having clean metallic contact surfaces, a file or a piece of emery paper being used to clean them.

Of all electrical magnitudes resistances are the easiest, both to make accurately and to preserve. It is therefore well to reduce as far as possible other electrical measurements to the measurement of resistances, and this may be done very extensively.

The production of given resistances for a definite purpose is of frequent occurrence, and this problem is usually solved by means of the sets of resistances (introduced by W. Siemens) after the plan of a set of weights. So many sets, however, would be necessary in a large laboratory that it is well to make arrangements for producing actual resistances of a given value.

For most purposes wire covered with silk will serve. German silver used to be almost exclusively employed; at the present time alloys containing zinc are avoided, "manganin" (copper-manganese)

and "constantan" (copper-nickel) being used. The first alloy has the advantage of an extraordinarily small temperature coefficient, but it must be protected against oxidising action, as manganese rusts very easily. The second alloy has a somewhat greater temperature coefficient, but is not liable to change.

If the resistances, as is usually the case in physical chemistry, have only to be accurate to 0.0005 or 0.001 of their value, it is an easy matter to produce them. A wire is selected so that the necessary length is not less than 2 m.; the resistance of a metre is determined to 1 per cent, and the length required then calculated. This length plus 10 cm. is cut off and placed in the Wheatstone bridge.

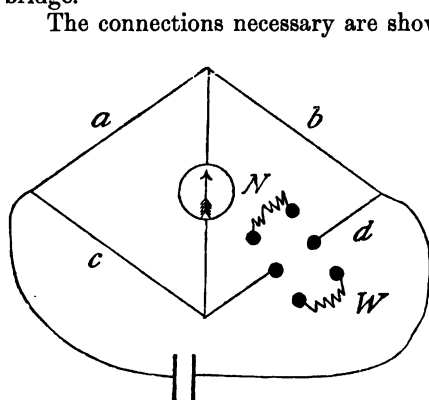

FIG. 170.

The connections necessary are shown in Fig. 170. Three of the four branches of the bridge consist of pieces of the same wire having approximately the same resistance as that to be produced. In the fourth branch there is a rocker connected, on the one hand, with the standard resistance N , and on the other with the copy W . The bridge is first balanced with N , most conveniently by connecting the two branches b and a by a piece of wire 10-20 cm. long, along which the wire from

the galvanometer may be slid and clamped fast. The rocker is then tipped over and the resistance W altered until the bridge is again in equilibrium. For security the observations with N and with W are repeated.

To be able to lengthen and shorten the wire W easily, its ends are held by two copper clamps with strong springs (Fig. 171) attached to the commutator. After equilibrium has been attained, the wire is bent over at the clamp, so that the length is determined to a few tenths of a millimetre.

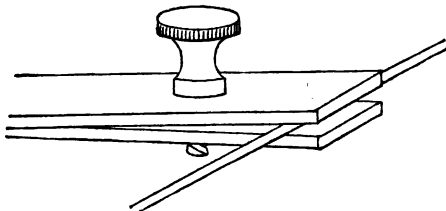

FIG. 171.

For the practical performance of such copying, a board is employed which carries the requisite clamps, mercury cups, and connections in the manner indicated in Fig. 172. The black discs are mercury

cups, the white ones are binding screws. A manganin wire is stretched between 1 and 9, along which slides a binding screw ;

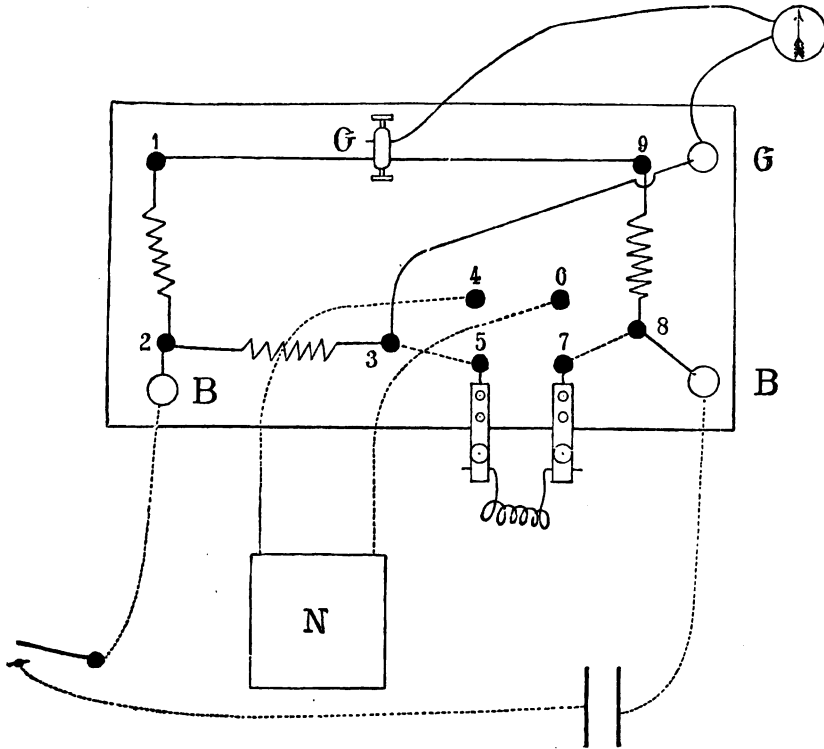

FIG. 172.

from this and the screw G , connected with 3, wires pass to the galvanometer. The battery wires lead to the binding screws BB , a key being introduced in the neighbourhood of the observer, and these are connected with the mercury cups 2 and 8. Between 1 : 2, 2 : 3, and 8 : 9, there come three resistances approximately equal to each other and to the resistance N to be copied, which is connected with 4 and 6 by means of stout wires. After the connections 3 : 4 and 6 : 8 are made by two short wires, the bridge is brought into equilibrium by moving G along the wire 1 : 9. The short wires are then transferred to 3 : 5 and 7 : 8, the resistance W is clamped fast, and its length varied until the bridge is again in equilibrium. N is again brought into the circuit to test if the original equilibrium has not been disturbed ; if it has, it is readjusted, the observation with W repeated, and the final adjustment made. When the apparatus is

once set up the work is very easy, and in a short time a large number of resistances accurate to 0.1 per cent can be produced.

For convenient manipulation the resistances are wound spirally. Wooden or other bobbins are only necessary for considerable lengths of wire. Shorter wires are doubled by bending at the middle, and the two parts are then wound simultaneously round the finger or a cylindrical piece of wood. The spiral so obtained is stripped off, tied together with thread, and saturated with melted paraffin. On solidification a resistance is obtained, which is compact, convenient to handle, and easy to connect. The ends of the wire are left sufficiently long to permit easy regulation and connection. It is well to make the final adjustment after the wire has been thus prepared.

For further use the resistances are attached to thick copper wires, pieces of brass, or the portions of the apparatus between which they are to be used. The attachment is made either by clamping or soldering, the latter being preferable as it is not liable to alteration.

Soldering.—There are two sorts of solder, soft and hard. The first consists of tin and lead, and melts at a very low temperature; the second is best prepared for physico-chemical purposes by melting a silver coin together with about its own weight of brass, on charcoal before the blowpipe, and hammering out the button on the anvil to a thin sheet, after heating, if necessary. Soft solder is very convenient to use, but does not hold very fast; hard solder melts with much greater difficulty, but is tough and permits the joints to be hammered, bent, and otherwise manipulated.

For soldering with soft solder a soldering solution is necessary. A solution of zinc chloride is most convenient for brass and zinc, the surfaces to be soldered together receiving a coating of it. Copper is soldered with sal-ammoniac. If small objects are to be joined, it is easiest to fasten them in the positions they are to occupy with regard to each other, moisten them with the solution, and heat them in the flame in contact with a piece of solder until the solder melts, the fused metal being then drawn at once by capillary action into the joint. It is best to cool with a jet of water, after which the soldered joint must be carefully freed from any zinc chloride remaining.

Larger objects which cannot be heated in the flame are soldered with a soldering bolt. The bolt consists of a prismatic block of copper terminating in an edge or point; the smallest sizes, 4-6 cm. long, are most suitable, and must be provided with an iron shank and a wooden handle. The bolt is heated until the solder melts freely upon it, and the edge is rubbed with a little solder on a piece of sal-ammoniac, whereby it becomes well tinned. After the groove has received a coating of the flux solution, a drop of solder is taken up on the bolt and rubbed along the groove, the places touched becoming hot enough to take the solder and unite.

If a small object has to be soldered to a large one, *e.g.* the thin

wire of a resistance coil to a brass tongue, the surface of the larger object where the soldering is to take place is moistened with the soldering solution and tinned with the bolt. The small wire, wetted with a trace of soldering solution, is then brought into position and soldered fast by momentary contact with the well-tinned bolt. If several joints have to be made on the same piece, they are all tinned first, before the separate pieces are soldered on.

As soft solder offers only slight resistance to shearing and bending, it is necessary, if the objects to be soldered are to withstand any considerable strain, to fit them together so that the joints are spread out as much as possible, and when feasible, so that they may have a certain hold quite irrespective of the soldering. For example, a wire should not be soldered to a rod squarely, as in Fig. 173, *a*, but should either be bent at right angles, the flattened-out bent portion being then soldered on (Fig. 173, *b*), or still better, should be fixed into a hole bored through the rod and soldered fast in that position (Fig. 173, *c*).

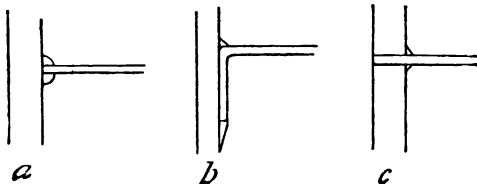

FIG. 173.

Hard solder should be used when the objects have to withstand a temperature of several hundred degrees, or when they have to offer considerable resistance to mechanical distortion, *i.e.* when they have to be bent, hammered, etc. The gas blowpipe is most useful in the laboratory for hard soldering, which then becomes not much more difficult than soft soldering.

The surfaces to be soldered, which ought to fit well, are placed together and held in position by binding with thin iron wire or otherwise. The joint is slightly wetted and dusted over with anhydrous borax, the object being then placed on a large block of charcoal and covered over with another block to retain the heat. A few very small clippings of the hard solder are then brought on to the joint and the blowpipe flame directed on the object, the pieces of solder being at first avoided. As soon as the borax is melted the solder sticks, and the flame is turned on the joint. The running of the solder is indicated by a sudden motion at the heated spot and the appearance of a shining metallic surface; the flame is then removed and the whole allowed to cool.

In soldering, attention must always be paid to having a clean metallic surface at the places on which the solder is to flow. The liquid solder obeys the laws of capillary action, filling up grooves and cracks automatically, provided that it wets the metal, and this is brought about by the flux (zinc chloride or borax) employed. After soldering, it is necessary to remove any flux that may remain. Joints

on electrical and other apparatus which have to come in contact with mercury, must be varnished over if they have been made with soft solder, for this becomes so soft under the action of mercury that it can be pressed to pieces between the fingers, and thus makes the connections quite insecure.

Conductivity of Electrolytes.—In determining the resistance of electrolytes we have to encounter the difficulty of rendering the polarisation at the electrodes of no effect. Of the various methods, that proposed by F. Kohlrausch, and based on the employment of alternating currents, is so greatly superior to all others in point of convenience of execution, combined with a sufficient degree of accuracy, that it alone concerns us here.

Rapidly alternating currents of equal amount but opposite direction diminish the polarisation very much, and reduce it practically to zero under conditions which can be easily produced. The Wheatstone bridge is employed, and the alternating currents are derived from a small induction coil, the absence of current in the bridge being indicated by a telephone. A diagram of the arrangement is given in Fig. 174.

The alternating currents from the induction coil J branch at a

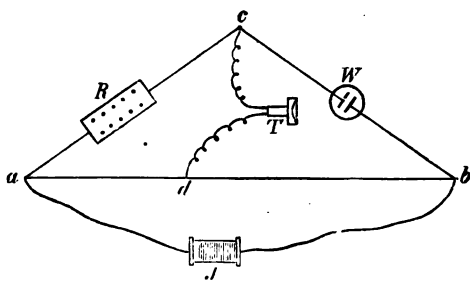

FIG. 174.

and b ; on the one hand they run through the measuring wire adb , and on the other through the resistance box R and the liquid resistance W to be measured. The telephone T is introduced between c and the sliding contact d . A resistance is put into R of the same order as that of

the liquid, and the contact d is moved until the telephone ceases to sound. None of the current then goes through cTd , and the resistances are in the proportion $W : R = db : ad$, or $W = R \frac{db}{ad}$. Kohl-

rausch had the measuring wire ab wound spirally on an insulating cylinder, in order to give it the greater length favourable for accurate reading without making it unhandy by the space it occupied. For most measurements, however, a stretched wire 1 m. long can be used instead of Kohlrausch's screw cylinder, as the other errors of experiment are usually greater than the error of adjustment.

Kohlrausch's apparatus, as employed for a number of years in my laboratory,¹ consists of an induction coil, measuring bridge, resistance

¹ *Zeit. physikal. Chem.*, 2, 561, 1888.

box, electrolytic vessel, and telephone; if a large number of experiments have to be made in succession, a thermostat is a great convenience.

The induction coil must be small and not have many turns. The want of success which several physicists experienced with Kohlrausch's method, lay in great measure in the excessive size of the induction apparatus they employed. Large coils set a relatively large quantity of electricity in motion, so that for each momentary current the polarisation at the electrodes exceeds what is allowable under the conditions of the process. There is no necessity for the employment of large inductors since the telephone is exceedingly sensitive, so that in reality the small cheap induction coils constructed for medical purposes are the most suitable as far as my experience goes. The spring of the interruptor must vibrate very rapidly, as the telephone is more sensitive for high tones than for low tones, and a sound like the singing of a gnat permits much more accurate work than deeper buzzing sounds. It is also well to remove the sliding metal sheath which is usually found between the primary coil and the iron core; this too makes the sounds more audible, as the electrical vibrations depart from the pure sine form, which is the least audible, and the upper tones are more strongly developed. One or two Leclanché elements will drive such an induction coil for a long time.

The measuring bridge consists of a platinum wire 100 cm. long stretched along a measure divided into millimetres, a movable contact being carried by a carriage sliding on the scale. The method of Strouhal and Barus¹ may be used for calibrating the wire, and is performed as follows:—

Ten approximately equal resistances of German silver are prepared (their total resistance being nearly the same as that of the platinum wire) by soldering on to the ends of equal lengths of a suitable wire short pieces of stout copper wire which are afterwards amalgamated. A strip of wood is laid down parallel to the bridge, and on it are placed nine mercury cups 11 cm. apart, the ten resistances being then arranged in them alongside of the measuring wire, as indicated in Fig. 175. The two wires from the induction coil are now connected with the ends *a* and *b*, and the telephone with the mercury cup 1 and the slider, by means of which the spot is found at which the telephone is silent. Now the first resistance *r*, which is provided with some mark to distinguish it from the others, is made to change places with the resistance formerly between 1 and 2; the position of the slider is then determined when the telephone is connected with 1, and again when it is connected with 2, the difference of the readings being noted. The resistance *r* is next brought between 2 and 3, and the process repeated, until *r* comes finally between 9 and *b*, at which position only one reading, with the tele-

¹ *Wied. Ann.*, 10, 326, 1880.

phone wire in 9, is necessary. By these measurements we have determined on the wire ten portions of equal resistance, each portion

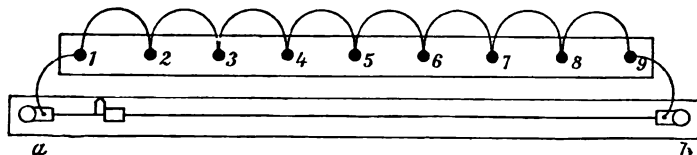

FIG. 175.

being approximately one-tenth of the whole. The ten differences are added up, and the difference between the sum and 100 cm. divided by ten, each separate value being corrected by the amount thus obtained, so that the sum is now exactly 100 cm. If the single corrected lengths are now added, thus: 1, 1 + 2, 1 + 2 + 3, . . ., we obtain the points which correspond to successive tenths of the wire, and the differences of these values from 10, 20, 30, . . . cm. are the corrections to be applied at the corresponding places. For example, if the sum of the first three lengths is 29.87 cm. to each reading in the neighbourhood of 30 cm., there must be added the correction + 0.13. The corrections should be written at the corresponding place on the scale and applied to the observed values before noting the result.

A common resistance box is used for comparison. It is possible to work with resistances of 10, 100, and 1000 ohms, but a complete box going up to 2000 or 10,000 ohms has important advantages. The better sort of resistance boxes now to be had from electricians are usually so well adjusted that the error is less than 0.001, and thus negligible for our purposes.

Spirally wound wire resistances, such as are almost exclusively employed, permit no accurate measurement beyond 2000 or 5000 ohms, the minimum in the telephone becoming indistinct. This has been mostly attributed to self-induction, which, however, is confined within as narrow limits as possible by "bifilar" winding, the wire being doubled and wound from the middle, so that everywhere there flow equal and opposite currents which practically destroy each other's inductive action. Chaperon,¹ following Kohlrausch's example, has shown that the electrostatic capacity of the resistance coils is much more active in producing the disturbance than their self-induction. By winding the resistances singly, but in such a way that each layer had the direction of winding changed, he obtained resistances which gave good minima up to 100,000 ohms.

As the conductivity of electrolytic solutions varies between very wide limits, different forms of resistance vessels should be used accord-

¹ *Comptes rendus*, 108, 799, 1889.

ing to circumstances. In most cases we have to deal with dilute solutions having a large resistance; for such cases a form whose essentials were suggested by Arrhenius gives the best results.

Two circular electrodes (Fig. 176) 3 or 4 cm. in diameter, and made of stout platinum foil, are provided with short stems of thick platinum wire, which are sealed into glass tubes by means of fusible enamel, so that the greater length of them projects into the tubes. The two electrodes are placed parallel to each other, the glass tube of one passing through a hole bored in the middle of the other, and are held in this position about 1 cm. apart by being fastened into an ebonite cover. The liquid to be investigated is placed in a thin-walled glass cylinder with a flat bottom, its section being filled by the electrodes as completely as is compatible with their free movement. The electrodes are fixed in position by means of a circular groove turned in the ebonite cover. Stout copper connecting wires are placed in the glass tubes of the electrodes, the connection with the platinum wires being made by means of a drop of mercury introduced into each tube.

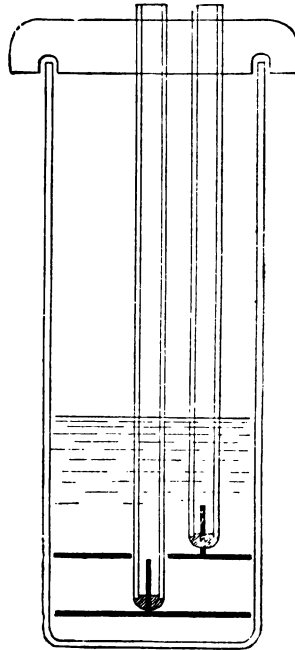

FIG. 176.

Some attention must be devoted to the selection of the glass for the resistance vessel, as the solubility of bad glass may cause considerable errors, when we take into consideration the extreme delicacy of the method.

Vessels of other shapes must be adopted with liquids which conduct well, as liquid resistances below 20 ohms cannot be accurately measured with alternating currents and the telephone. Some useful forms, most of them suggested by Kohlrausch, are shown in Figs. 177-180.

The electrodes must be platinised, *i.e.* covered with platinum black. The platinising is best done by filling the vessel with very dilute chloroplatinic acid, and passing a current of 4-5 volt E.M.F. with occasional change of direction until the two electrodes are covered with a velvety black coating of finely divided platinum. After platinising they must be very carefully washed out, as the platinising solution adheres to the coating with surprising obstinacy.

According to my own experience, an ordinary Bell telephone

fulfils mostly all requirements. The most sensitive instruments with which I am acquainted are those manufactured by L. M. Ericsson & Co.,

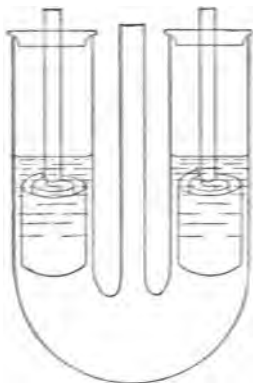

FIG. 177.

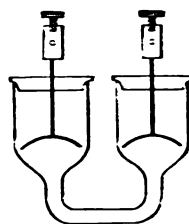

FIG. 178.

Thulegatan, Stockholm; they are far superior to those specially made by certain firms for conductivity determinations.

The beginner experiences a certain difficulty from the noise of the induction coil interfering with the determination of the sound minimum in the telephone. It can only be partially prevented by

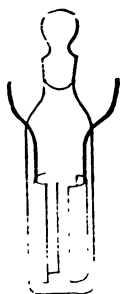

FIG. 179, a.

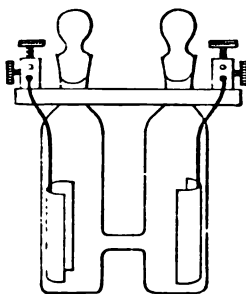

FIG. 179, b.

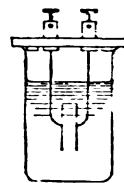

FIG. 180.

covering or wrapping up the induction coil; removing it to another room altogether occasions other inconveniences. The most suitable way is to stop up the unemployed ear with a metal or glass bulb (the "antiphone") of suitable size. Good measurements can then be made, even when there is quite considerable external noise, after one has learned to press the telephone properly to the ear.

The construction of the measuring bridge is gone about as follows:—

On a seasoned board, 110-120 cm. long and 6-8 cm. wide, a wooden

metre measure divided into millimetres is fixed by means of counter-sunk screws and supporting rings in such a way that it rests a few millimetres above the board. A slider is then bent out of a piece of stout sheet brass, so that it grasps the scale and can be moved freely along the whole length. It only fits close at the edges, and is arched a few millimetres high between them; its form may be seen from Fig. 181, which represents a section across the bridge. A binding screw is attached to the slider, and besides this it carries the contact, which is made of a piece of stout copper wire hammered out flat to an edge at the place where it rests on the measuring wire. Its shape, viewed from above, is seen in Fig. 182. The double bend gives it

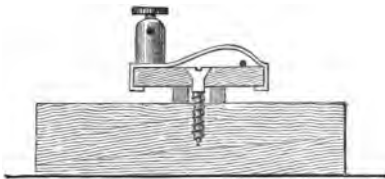

FIG. 181.

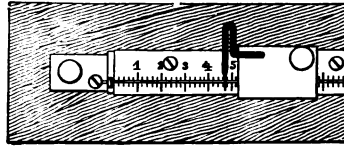

FIG. 182.

the elasticity necessary for keeping it in contact with the measuring wire while the slider moves, without damaging it by too great pressure.

The measuring wire, 0.2 mm. diameter, should be of platinum containing iridium. German silver is not suitable, as it soon becomes coated in the laboratory with badly conducting films of oxides and chlorides, which occasion irregular noises in the telephone as the slider is moved.

To place the wire into position, two strong pieces of brass bent at right angles are fastened close against the ends of the metre measure, the wire is stretched along the scale, and is finally attached to the brass ends with a little solder. One end of the measure is shown in section lengthwise in Fig. 183.

The apparatus is connected up, as in Fig. 174 (p. 222), and the connections between *a*, *b*, and *c* must be made of very stout copper wire.

The measurements are performed very rapidly if the liquids are already prepared. If the same substance has to be investigated at various

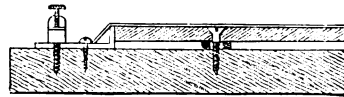

FIG. 183.

concentrations, the dilution is best effected in the resistance vessel itself, accurately known quantities of the solution being removed by means of a pipette, and their place supplied by water, which has been warmed in the thermostat to the temperature of experiment. If a number of different liquids have to be investigated, the vessels containing them are placed in the thermostat some

time beforehand, so that no time may be lost in equalising the temperature.

The telephone does not usually give an absolutely sharp minimum, but it is easy to find two neighbouring points 0.5 to 2.0 mm. apart, at which the sound begins to increase distinctly; the middle point between them is the true minimum, and after some practice can be easily determined to 0.2 or 0.3 mm. Now at the middle of the bridge 1 mm. change of position corresponds to 0.4 % change on the conductivity, so that the limit given above permits a determination of the conductivity to 0.1 %, a degree of accuracy quite sufficient for our purposes. If the minimum should become indistinct, re-platinising the electrodes will usually be found to remedy the defect.

Molecular Conductivity.—The conductivity of an electrolyte is expressed as molecular conductivity. This is the conductivity possessed by 1 gram-molecule of the electrolyte when brought between two electrodes 1 cm. apart. In the case of solutions, the quantity of solution which contains 1 gram-molecule is taken. If l is the specific conductivity, *i.e.* the reciprocal of the resistance between two opposite faces of a cube of 1 cm. edge, the molecular conductivity μ is equal to lv , where v is the volume of 1 gram-molecule of the electrolyte expressed in cubic centimetres, *i.e.* its molecular volume.

In a vessel, such as is used for the determination of the conductivity, it is not this volume of liquid which is between the electrodes, and the conductivity measured in the vessel stands to the specific conductivity in a ratio which depends on the shape and size of the vessel and the electrodes. The numerical factor k which reduces the observed conductivity to the specific conductivity is called by Kohlrausch the resistance capacity of the vessel. In order to determine it, a liquid of known specific conductivity must be measured in the vessel, the observed conductivity being then divided into the specific conductivity. If, therefore, L is the measured conductivity of a liquid having the specific conductivity l , $kL = l$, or $k = \frac{l}{L}$; if the conductivity L' of another solution is measured in the same vessel, its specific conductivity is $l' = kL'$. The specific conductivity of a $\frac{1}{50}$ normal potassium chloride solution which contains 74.59 g. in 50 litres of solution is 2.244×10^{-3} at 18°, and 2.594×10^{-3} at 25°. We refer all other values to these, which are not expressed in reciprocal ohms, but in Siemens mercury units. We can retain these traditional values without detriment.

If, in the arrangement of Fig. 174, the length of wire ad is expressed by a and db by b , the conductivity of the vessel, when w is the resistance in the box, is $L = \frac{a}{bw}$, the specific conductivity therefore

is $l = kL = k \frac{a}{bw}$, and since $\mu = vl$, we obtain the

$$\text{molecular conductivity } \mu = k \frac{av}{bw},$$

a formula which is in constant use. It is perhaps clearer to calculate the resistance capacity from the fact (in agreement with that given above) that the molecular conductivity of a $\frac{1}{50}$ normal solution of potassium chloride is 112.2 at 18° and 129.7 at 25°. If a determination with this solution is made in a vessel of unknown resistance capacity, the capacity is found from the formula $k = \mu \frac{bw}{av}$,

and since $v = 50,000$, we have $k = 2.244 \frac{bw}{a} \times 10^{-3}$ at 18° and $k = 2.594 \frac{bw}{a} \times 10^{-3}$ at 25° as before.

The following table is used for calculating the ratio $\frac{a}{b}$ for a wire 1 metre long :—

TABLE

TABLE FOR WHEATSTONE'S BRIDGE

$$\frac{a}{1-a} \text{ from } a = 0.001 \text{ to } 0.999$$

a	0	1	2	3	4	5	6	7	8	9
00	0.0000	0010	0020	0030	0040	0050	0060	0071	0081	0091
01	0101	0111	0122	0132	0142	0152	0163	0173	0183	0194
02	0204	0215	0225	0235	0246	0256	0267	0278	0288	0299
03	0309	0320	0331	0341	0352	0363	0373	0384	0395	0406
04	0417	0428	0438	0449	0460	0471	0482	0493	0504	0515
05	0526	0537	0549	0560	0571	0582	0593	0605	0616	0627
06	0638	0650	0661	0672	0684	0695	0707	0718	0730	0741
07	0753	0764	0776	0788	0799	0811	0823	0834	0846	0858
08	0870	0881	0893	0905	0917	0929	0941	0953	0965	0977
09	0989	1001	1013	1025	1038	1050	1062	1074	1087	1099
10	0.1111	1124	1136	1148	1161	1173	1186	1198	1211	1223
11	1236	1249	1261	1274	1287	1299	1312	1325	1338	1351
12	1364	1377	1390	1403	1416	1429	1442	1455	1468	1481
13	1494	1508	1521	1534	1547	1561	1574	1588	1601	1614
14	1628	1641	1655	1669	1682	1696	1710	1723	1737	1751
15	1765	1779	1793	1806	1820	1834	1848	1862	1877	1891
16	1905	1919	1933	1947	1962	1976	1990	2005	2019	2034
17	0.2048	2063	2077	2092	2107	2121	2136	2151	2166	2180
18	2195	2210	2225	2240	2255	2270	2285	2300	2315	2331
19	2346	2361	2376	2392	2407	2422	2438	2453	2469	2484
20	2500	2516	2531	2547	2563	2579	2595	2610	2626	2642
21	2658	2674	2690	2707	2723	2739	2755	2771	2788	2804
22	2821	2837	2854	2870	2887	2903	2920	2937	2953	2970
23	2987	3004	3021	3038	3055	3072	3089	3106	3123	3141
24	0.3158	3175	3193	3210	3228	3245	3263	3280	3298	3316
25	3333	3351	3369	3387	3405	3423	3441	3459	3477	3495
26	3514	3532	3550	3569	3587	3605	3624	3643	3661	3680
27	3699	3717	3736	3755	3774	3793	3812	3831	3850	3870
28	3889	3908	3928	3947	3967	3986	4006	4025	4045	4065
29	0.4085	4104	4124	4144	4164	4184	4205	4225	4245	4265

<i>a</i>	0	1	2	3	4	5	6	7	8	9
30	4286	4306	4327	4347	4368	4389	4409	4430	4451	4472
31	4493	4514	4535	4556	4577	4599	4620	4641	4663	4684
32	4706	4728	4749	4771	4793	4815	4837	4859	4881	4903
33	4925	4948	4970	4993	5015	5038	5060	5083	5106	5129
34	0·5152	5175	5198	5221	5244	5267	5291	5314	5337	5361
35	5385	5408	5432	5456	5480	5504	5528	5552	5576	5601
36	5625	5650	5674	5699	5723	5748	5773	5798	5823	5848
37	5873	5898	5924	5949	5974	6000	6026	6051	6077	6103
38	0·6129	6155	6181	6208	6234	6260	6287	6313	6340	6367
39	6393	6420	6447	6475	6502	6529	6556	6584	6611	6639
40	6667	6695	6722	6750	6779	6807	6835	6863	6892	6921
41	6949	6978	7007	7036	7065	7094	7123	7153	7182	7212
42	0·7241	7271	7301	7331	7361	7391	7422	7452	7483	7513
43	7544	7575	7606	7637	7668	7699	7731	7762	7794	7825
44	7857	7889	7921	7953	7986	8018	8051	8083	8116	8149
45	0·8182	8215	8248	8282	8315	8349	8382	8416	8450	8484
46	8519	8553	8587	8622	8657	8692	8727	8762	8797	8832
47	8868	8904	8939	8975	9011	9048	9084	9121	9157	9194
48	0·9231	9268	9305	9342	9380	9418	9455	9493	9531	9570
49	9608	9646	9685	9724	9763	9802	9841	9881	9920	9960
50	1·000	1·004	1·008	1·012	1·016	1·020	1·024	1·028	1·033	1·037
51	1·041	1·045	1·049	1·053	1·058	1·062	1·066	1·070	1·075	1·079
52	1·083	1·088	1·092	1·096	1·101	1·105	1·110	1·114	1·119	1·123
53	1·128	1·132	1·137	1·141	1·146	1·151	1·155	1·160	1·165	1·169
54	1·174	1·179	1·183	1·188	1·193	1·198	1·203	1·208	1·212	1·217
55	1·222	1·227	1·232	1·237	1·242	1·247	1·252	1·257	1·262	1·268
56	1·273	1·278	1·283	1·288	1·294	1·299	1·304	1·309	1·315	1·320
57	1·326	1·331	1·336	1·342	1·347	1·353	1·358	1·364	1·370	1·375
58	1·381	1·387	1·392	1·398	1·404	1·410	1·415	1·421	1·427	1·433
59	1·439	1·445	1·451	1·457	1·463	1·469	1·475	1·481	1·488	1·494
60	1·500	1·506	1·513	1·519	1·525	1·532	1·538	1·545	1·551	1·558
61	1·564	1·571	1·577	1·584	1·591	1·597	1·604	1·611	1·618	1·625
62	1·632	1·639	1·646	1·653	1·660	1·667	1·674	1·681	1·688	1·695
63	1·703	1·710	1·717	1·725	1·732	1·740	1·747	1·755	1·762	1·770
64	1·778	1·786	1·793	1·801	1·809	1·817	1·825	1·833	1·841	1·849
65	1·857	1·865	1·874	1·882	1·890	1·899	1·907	1·915	1·924	1·933
66	1·941	1·950	1·959	1·967	1·976	1·985	1·994	2·003	2·012	2·021
67	2·030	2·040	2·049	2·058	2·067	2·077	2·086	2·096	2·106	2·115
68	2·125	2·135	2·145	2·155	2·165	2·175	2·185	2·195	2·205	2·215
69	2·226	2·236	2·247	2·257	2·268	2·279	2·289	2·300	2·311	2·322

α	0	1	2	3	4	5	6	7	8	9
70	2·333	2·344	2·356	2·367	2·378	2·390	2·401	2·413	2·425	2·436
71	2·448	2·460	2·472	2·484	2·497	2·509	2·521	2·534	2·546	2·559
72	2·571	2·584	2·597	2·610	2·623	2·636	2·650	2·663	2·676	2·690
73	2·704	2·717	2·731	2·745	2·759	2·774	2·788	2·802	2·817	2·831
74	2·846	2·861	2·876	2·891	2·906	2·922	2·937	2·953	2·968	2·984
75	3·000	3·016	3·032	3·049	3·065	3·082	3·098	3·115	3·132	3·149
76	3·167	3·184	3·202	3·219	3·237	3·255	3·274	3·292	3·310	3·329
77	3·348	3·367	3·386	3·405	3·425	3·444	3·464	3·484	3·505	3·525
78	3·545	3·566	3·587	3·608	3·630	3·651	3·673	3·695	3·717	3·739
79	3·762	3·785	3·808	3·831	3·854	3·878	3·902	3·926	3·950	3·975
80	4·000	4·025	4·051	4·076	4·102	4·128	4·155	4·181	4·208	4·236
81	4·263	4·291	4·319	4·348	4·376	4·405	4·435	4·465	4·495	4·525
82	4·556	4·587	4·618	4·650	4·682	4·714	4·747	4·780	4·814	4·848
83	4·882	4·917	4·952	4·988	5·024	5·061	5·098	5·135	5·173	5·211
84	5·250	5·289	5·329	5·369	5·410	5·452	5·494	5·536	5·579	5·623
85	5·667	5·711	5·757	5·803	5·849	5·897	5·944	5·993	6·042	6·092
86	6·143	6·194	6·246	6·299	6·353	6·407	6·463	6·519	6·576	6·634
87	6·692	6·752	6·813	6·874	6·937	7·000	7·065	7·130	7·197	7·264
88	7·333	7·403	7·475	7·547	7·621	7·696	7·772	7·850	7·929	8·009
89	8·091	8·174	8·259	8·346	8·434	8·524	8·615	8·709	8·804	8·901
90	9·000	9·101	9·204	9·309	9·417	9·526	9·638	9·753	9·870	9·989
91	10·11	10·33	10·36	10·49	10·63	10·77	10·90	11·05	11·20	11·35
92	11·50	11·66	11·82	11·99	12·16	12·33	12·51	12·70	12·89	13·08
93	13·29	13·49	13·71	13·93	14·15	14·38	14·63	14·87	15·13	15·39
94	15·67	15·95	16·24	16·54	16·86	17·18	17·52	17·87	18·23	18·61
95	19·00	19·41	19·83	20·28	20·74	21·22	21·73	22·26	22·81	23·39
96	24·00	24·64	25·32	26·03	26·78	27·57	28·41	29·30	30·25	31·26
97	32·33	33·48	34·71	36·04	37·46	39·00	40·67	42·48	44·45	46·62
98	49·00	51·6	54·6	57·8	61·5	65·7	70·4	75·9	82·3	89·9
99	99·0	110	124	142	166	199	249	332	499	999

Besides the molecular conductivity, the equivalent conductivity is also used. This is derived from the molecular conductivity by dividing it by the valency, which in acids is the same as the basicity, with bases the same as the acidity, and with salts equal to the number of acid or basic valencies occurring in the formula. Thus the equivalent conductivity of barium chloride, BaCl_2 , is equal to half the molecular conductivity, and in aluminium sulphate, $\text{Al}_2(\text{SO}_4)_3$, equal to a sixth.

The Dissociation Constant.—Moderately dissociated binary electrolytes, especially very many acids, show a variation of their molecular conductivity with the volume which proceeds according to the equation

$$\frac{\mu_v^2}{\mu_\infty(1 - \mu_v)v} = k,$$

where μ_v is the molecular conductivity at the volume v , μ_∞ the limiting value of the molecular conductivity at infinite dilution, and k a constant, not to be confused, however, with the resistance capacity of the preceding paragraph also denoted by k . As the constant k is intimately connected with the constitution of the acid, its determination is of considerable interest.

The magnitude μ_v is deduced as in the preceding paragraph; μ_∞ can be determined from the molecular conductivity of the sodium salt. In the case of the more complex acids, it is possible to estimate μ_∞ with sufficient approximation from the number of atoms in the molecule, so that in most cases the direct determination need not be performed.

At 25° we have for

Acids with 12 atoms,	$\mu_\infty = 358$
" 15 " "	356
" 18 " "	354
" 22 " "	352
" 25 " "	351
" 30 " "	350

For acetic acid we have $\mu_\infty = 364$, propionic acid 359, benzoic acid 356.

The volume v is generally expressed in litres, but as the constant k has then usually a very small value, it has become customary to call $K = 100k$ the dissociation constant, or better, the dissociation coefficient. For acetic acid $K = 0.00180$, and for benzoic acid $K = 0.0060$. A collection of the values of K for a great number of acids will be found in *Zeit. physikal. Chem.*, **3**, 418 (1889).

In carrying out such determinations practically, we determine not only the molecular conductivity for a single solution, but for a whole

series of dilutions, prepared in the resistance vessel itself, which is best of the form given by Arrhenius (Fig. 176, p. 225).

First of all a standardised solution of barium hydroxide is prepared, and the strength of a dilute solution of the acid ascertained by its means. The solution should not be stronger than decinormal. A quantity (100-200 cc.) of distilled water is placed in a bottle weighted with lead and surrounded by the water of the thermostat, so that it may be warmed to 25°. The resistance vessel then receives 10 cc. of the acid solution. After the electrodes are put in, seven to ten minutes elapse before the solution assumes the temperature of the bath. In the meantime, the resistance is ascertained which will bring the slider approximately to the middle of the bridge, and when the temperature becomes constant, the measurement is made.

Then 10 cc. of the warmed water is introduced into the vessel with a special pipette, and mixed with the solution by moving the electrodes up and down. After three to five minutes another measurement is made. With the first pipette 10 cc. of the solution are next removed and 10 cc. of water substituted, another determination being then made, and so on until the solution becomes more dilute than millinormal, after which no accurate measurements are possible.

The dilution pipettes, one of which must be used only for water, to prevent impurities being introduced, have to be specially weighed out with water, so that the water pipette delivers exactly 10 cc. on free running out, while the other, after it has stood for five minutes on filter-paper, takes in exactly 10 cc. when filled up to the mark. The operations are performed as indicated on p. 85, the water from two marks on the first pipette being weighed, and the position of the final mark between them calculated. The second pipette is wetted inside and allowed to stand for five minutes on filter-paper, somewhat more than 10 g. is removed from a tared flask containing water, and after a 10 g. weight has been removed from the other pan of the balance, enough water is allowed to flow into the flask from the pipette to establish equilibrium within a few milligrams. If this operation is successful, the jet of the pipette is stopped up with a pellet of adhesive wax, and the mark put on the stem. The pipettes are tested by taking water out of a tared flask several times with the second pipette, and filling again with the first pipette; the weight should remain constant to 1 or 2 centigrams.

Pure Water.—The specific conductivity of the purest water known is approximately 0.25×10^{-6} , *i.e.* a cube of 1 cm. edge has a resistance of 4×10^6 mercury units between its parallel faces. Water so pure as this can only be prepared by distillation in vacuo, and cannot be kept without its conductivity increasing rapidly on account of it taking up foreign matter from the air.

It is an important matter in measuring conductivities to obtain a supply of pure water. It is best prepared by distilling water as free

from ammonia as possible (spring water, not river water), with addition of a little milk of lime to fix the carbonic acid. With a rationally constructed distilling apparatus, especially one provided with a drop-catcher, it is possible to obtain, without any further precaution than seeing that the distillation does not take place too rapidly, water with the specific conductivity 2×10^{-6} , which can be used for most experiments.

Ordinary distilled water has in probably all cases a much greater conductivity. This is in great measure due to carbonic acid, which occurs in almost every specimen of distilled water in considerable quantity. Its presence may be ascertained by adding an equal volume of clear baryta water, when a cloudiness due to the formation of barium carbonate at once appears. According to Kohlrausch,¹ a water of this description may be greatly improved by passing through it a current of air free from carbonic acid.

Another means of purifying distilled water has been suggested by Nernst.² The water is partially frozen in a large bottle, and after the liquid portion, which contains the dissolved substances, has been decanted off, the residue is melted and used in the experiments. This process depends on the fact that pure ice separates from dilute solutions, the solution of the foreign substances, the freezing point of which is lower, remaining liquid.

In calculating the molecular conductivity of neutral substances, the conductivity of the water must be deducted. The calculation is performed by multiplying the specific conductivity w by the molecular volume v of the solution expressed in cubic centimetres, and subtracting the product from the molecular conductivity calculated in the usual way. With a water of medium quality (sp. cond. = 2×10^{-6}) the correction for a dilution of 100 l. or 10^5 cc. is only 0.2 units, and for a thousandth normal solution 2 units. As the molecular conductivity of neutral salts is in round numbers 100, it is plain that for solutions more dilute than $\frac{1}{500}$ normal the correction exceeds 0.1 per cent, and must therefore be taken into consideration.

With acids and bases the case is different. Here the conductivity of the impurities dissolved in the water is not simply added to the conductivity of the substance, and there may even be a diminution of the conductivity if the impurity neutralises the acid or the base. In such cases it is most rational to apply no correction for the water when strong acids or bases are being dealt with. With weak acids of the character of acetic acid there is no diminution of the conductivity when basic impurities are present. For such substances one-half of the above correction may be applied, but in each case it should be stated whether and in what way the conductivity of the water has received consideration.

Basicity of Acids.—Metallic sodium freed from the crust of

¹ *Wied. Ann.*, **44**, 583 (note), 1891.

² *Zeit. physikal. Chem.*, **8**, 120, 1891.

hydrate, etc., is placed in a platinum or silver basin under a bell-jar, together with some water, the entrance of carbonic acid being prevented by means of a soda-lime tube. Under these circumstances the sodium is transformed in the course of a few days into caustic soda, which is dissolved in water and brought up to the strength $\frac{1}{32}$ normal.

About 20 cc. of this solution is coloured pink with a trace of phenol-phthalein and treated with the dry acid until the colour vanishes. It is then filtered through a small filter, the first few drops being discarded,¹ and neutralised by careful addition of the soda solution; the liquid, however, should rather be on the acid than on the alkaline side.

The conductivity of this $\frac{1}{32}$ equivalent normal solution of sodium salt is then determined, after which it is diluted to 1024 l., as described on p. 234. If the equivalent conductivities for the dilutions 32 and 1024 are calculated, and their difference Δ taken, the quotient $n = \frac{\Delta}{10}$ gives the valency, for in the case of monobasic acids Δ is in round numbers 10, for dibasic acids 20, and so on. The rule has been tested and confirmed as far as pentabasic acids; it is, however, not quite strict, inasmuch as Δ may vary from $10n$ by several units, according to the nature and composition of the acid.

Table for the Dissociation Constant.—In order to simplify the somewhat complicated calculation of the constant k , the following table has been constructed to give the values of the function $\frac{m^2}{1-m}$ for $m = 0.0100$ to 0.0999 , and for $m = 0.100$ to 0.999 . The quotient $\frac{\mu_v}{\mu_\infty}$ is denoted by m .

¹ Most substances in solution adhere to the filter-paper by absorption, the first drops that run through being therefore weaker than the bulk of the solution.

TABLE FOR CALCULATING THE DISSOCIATION CONSTANT

$$k = \frac{m^2}{1-m}, \text{ from } m = 0.001 \text{ to } 0.0999 \text{ and}$$

from $m = 0.100$ to 0.999

<i>m</i>	0	1	2	3	4	5	6	7	8	9
0.010	1010	1030	1051	1072	1093	1114	1136	1157	1179	1201
11	1223	1246	1268	1291	1315	1337	1361	1385	1408	1433
12	1457	1482	1507	1532	1557	1582	1608	1633	1659	1686
13	1712	1739	1765	1792	1820	1847	1875	1903	1931	1959
14	1987	2016	2045	2074	2104	2133	2163	2193	2223	2253
15	2284	2314	2345	2376	2408	2440	2473	2505	2537	2569
16	2602	2635	2668	2706	2734	2768	2802	2836	2871	2905
17	2940	2975	3010	3046	3081	3118	3154	3190	3226	3262
18	3299	3336	3373	3411	3449	3487	3525	3563	3602	3641
19	3680	3719	3758	3798	3838	3878	3918	3958	3999	4040
0.020	4082	4123	4164	4206	4248	4290	4333	4376	4418	4461
21	4505	4548	4591	4635	4680	4724	4759	4813	4858	4903
22	4949	4994	5041	5087	5133	5179	5226	5273	5320	5367
23	5415	5462	5510	5558	5607	5655	5704	5753	5802	5852
24	5902	5952	6002	6052	6103	6154	6204	6256	6307	6358
25	6410	6462	6514	6567	6619	6672	6725	6778	6832	6886
26	6940	6995	7049	7104	7159	7213	7269	7324	7380	7436
27	7492	7548	7605	7662	7719	7777	7834	7892	7949	8007
28	8066	8124	8183	8242	8301	8360	8420	8478	8538	8599
29	8661	8721	8782	8844	8905	8966	9028	9090	9152	9215
0.030	9278	9341	9404	9467	9531	9595	9659	9723	9788	9852
31	9917	9982	1005	1011	1017	1025	1031	1038	1044	1051
32	1057	1063	1070	1077	1084	1091	1098	1104	1111	1118
33	1125	1132	1138	1146	1153	1160	1167	1174	1181	1188
34	1196	1204	1212	1219	1226	1233	1241	1248	1255	1263
35	1270	1277	1285	1292	1300	1307	1314	1322	1330	1337
36	1345	1352	1360	1368	1375	1383	1391	1398	1406	1414
37	1422	1430	1438	1446	1454	1462	1470	1478	1486	1494
38	1502	1510	1518	1526	1534	1543	1551	1559	1567	1575
39	1583	1592	1600	1608	1616	1625	1633	1642	1650	1658

<i>m</i>	0	1	2	3	4	5	6	7	8	9
0·040	1667	1675	1684	1692	1701	1710	1718	1727	1736	1744
41	1753	1762	1770	1779	1788	1797	1805	1814	1823	1832
42	1841	1850	1859	1868	1877	1886	1895	1904	1913	1922
43	1932	1941	1950	1959	1968	1978	1987	1996	2005	2015
44	2024	2034	2043	2053	2062	2071	2081	2090	2100	2110
45	2119	2129	2139	2149	2159	2168	2178	2188	2198	2208
46	2217	2227	2237	2247	2257	2267	2277	2287	2297	2307
47	2317	2327	2337	2347	2357	2368	2379	2389	2399	2409
48	2420	2430	2440	2450	2461	2471	2482	2492	2503	2513
49	2524	2534	2545	2555	2566	2577	2587	2599	2610	2620
0·050	2631	2642	2653	2663	2674	2685	2696	2707	2718	2729
51	2741	2752	2763	2774	2785	2796	2807	2818	2829	2840
52	2852	2863	2874	2885	2897	2908	2919	2931	2942	2953
53	2965	2977	2989	3000	3012	3023	3035	3047	3058	3070
54	3081	3093	3105	3116	3128	3140	3152	3164	3176	3187
55	3199	3211	3223	3235	3248	3260	3272	3284	3296	3308
56	3321	3333	3345	3357	3370	3383	3395	3407	3419	3432
57	3444	3457	3469	3481	3494	3507	3520	3532	3545	3558
58	3570	3583	3595	3608	3621	3634	3647	3660	3673	3686
59	3699	3711	3724	3737	3751	3764	3777	3790	3803	3816
0·060	3830	3843	3856	3870	3883	3896	3910	3923	3936	3950
61	3963	3977	3990	4004	4017	4030	4044	4057	4071	4084
62	4098	4111	4125	4139	4153	4166	4180	4194	4208	4222
63	4236	4250	4264	4278	4292	4306	4320	4334	4348	4362
64	4376	4391	4405	4419	4434	4448	4462	4477	4491	4505
65	4519	4534	4548	4563	4577	4592	4606	4621	4635	4650
66	4664	4679	4694	4708	4723	4738	4752	4767	4782	4796
67	4811	4826	4841	4856	4871	4886	4901	4916	4931	4946
68	4961	4976	4992	5007	5023	5038	5054	5069	5085	5100
69	5115	5130	5146	5161	5177	5192	5208	5223	5239	5254
0·070	5269	5284	5300	5316	5331	5347	5362	5378	5394	5410
71	5426	5442	5458	5474	5490	5506	5522	5538	5554	5570
72	5586	5602	5619	5636	5652	5668	5685	5701	5717	5733
73	5749	5766	5782	5799	5815	5832	5848	5865	5881	5898
74	5914	5931	5947	5964	5981	5997	6014	6031	6047	6064
75	6081	6098	6115	6132	6149	6166	6183	6200	6217	6234
76	6251	6268	6286	6303	6320	6338	6355	6372	6390	6407
77	6424	6442	6459	6477	6494	6512	6529	6547	6564	1582
78	6599	6617	6634	6652	6670	6687	6705	6723	6740	6758
79	6776	6794	6812	6829	6847	6865	6883	6901	6919	6937

<i>m</i>	0	1	2	3	4	5	6	7	8	9
0.080	6955	6973	6992	7010	7029	7047	7066	7084	7103	7121
81	7139	7158	7176	7197	7215	7234	7252	7270	7288	7307
82	7325	7344	7362	7381	7400	7418	7437	7456	7475	7494
83	7513	7532	7551	7570	7589	7608	7627	7646	7665	7684
84	7703	7722	7741	7761	7780	7799	7819	7838	7857	7876
85	7896	7916	7935	7955	7975	7994	8014	8033	8053	8072
86	8092	8112	8131	8151	8171	8190	8210	8230	8250	8270
87	8290	8310	8330	8350	8370	8391	8411	8431	8451	8471
88	8491	8511	8532	8552	8572	8593	8613	8633	8654	8674
89	8695	8715	8736	8757	8777	8798	8819	8839	8860	8881
0.090	8901	8922	8942	8963	8984	9005	9026	9047	9068	9089
91	9110	9131	9152	9173	9195	9216	9237	9258	9280	9301
92	9322	9343	9365	9386	9408	9429	9451	9472	9494	9515
93	9536	9557	9579	9601	9622	9644	9666	9687	9709	9731
94	9753	9775	9796	9818	9840	9862	9884	9906	9928	9950
95	9972	9994	1002	1004	1006	1008	1011	1013	1015	1017
96	1020	1022	1024	1027	1029	1031	1033	1036	1038	1040
97	1042	1044	1047	1049	1051	1054	1056	1058	1060	1063
98	1065	1067	1069	1072	1074	1076	1079	1081	1083	1086
99	1088	1090	1092	1095	1097	1099	1101	1104	1106	1109
0.10	1111	1135	1159	1183	1207	1232	1257	1282	1308	1333
11	1360	1386	1413	1440	1467	1494	1522	1550	1579	1607
12	1636	1666	1695	1725	1755	1786	1817	1848	1879	1911
13	1943	1975	2007	2040	2073	2107	2141	2175	2209	2244
14	2279	2314	2350	2386	2422	2459	2496	2533	2571	2609
15	2647	2686	2725	2764	2803	2843	2883	2924	2965	3006
16	3048	3090	3132	3174	3217	3261	3304	3348	3392	3437
17	3482	3527	3573	3619	3665	3712	3759	3807	3855	3903
18	3951	4000	4049	4099	4149	4199	4250	4301	4353	4403
19	4457	4509	4562	4616	4670	4724	4778	4833	4888	4944
0.20	5000	5056	5113	5171	5228	5286	5345	5403	5463	5522
21	5582	5643	5704	5765	5826	5889	5951	6014	6077	6141
22	6205	6270	6335	6400	6466	6532	6599	6666	6734	6802
23	6870	6939	7008	7078	7148	7219	7290	7362	7434	7506
24	7579	7652	7726	7800	7875	7950	8026	8102	8179	8256
25	8333	8411	8490	8569	8648	8728	8809	8890	8971	9053
26	9135	9218	9301	9385	9470	9554	9640	9726	9812	9899
27	9986	1007	1016	1025	1034	1043	1052	1061	1070	1080
28	1089	1099	1108	1117	1127	1136	1146	1155	1165	1175
29	1185	1194	1204	1214	1224	1234	1245	1255	1265	1275

t m	0	1	2	3	4	5	6	7	8	9
0·30	1286	1296	1307	1317	1328	1339	1349	1360	1371	1382
31	1393	1404	1415	1426	1437	1449	1460	1471	1483	1494
32	1506	1518	1529	1541	1553	1565	1577	1589	1601	1613
33	1625	1638	1650	1663	1675	1688	1700	1713	1726	1739
34	1752	1765	1778	1791	1804	1817	1831	1844	1857	1871
35	1885	1898	1912	1926	1940	1954	1968	1982	1996	2011
36	2025	2040	2054	2068	2083	2098	2113	2128	2143	2158
37	2173	2188	2203	2219	2234	2250	2266	2281	2297	2313
38	2329	2345	2361	2378	2394	2410	2427	2443	2460	2477
39	2493	2510	2527	2545	2562	2579	2596	2614	2631	2649
0·40	2667	2685	2702	2720	2739	2757	2775	2793	2812	2830
41	2849	2868	2887	2906	2925	2944	2963	2983	3002	3022
42	3041	3061	3081	3101	3121	3141	3162	3182	3203	3223
43	3244	3265	3286	3307	3328	3349	3371	3392	3414	3435
44	3457	3479	3501	3523	3546	3568	3591	3613	3636	3659
45	3682	3705	3728	3752	3775	3799	3822	3846	3870	3894
46	3919	3943	3967	3992	4017	4042	4067	4092	4117	4142
47	4168	4194	4219	4245	4271	4298	4324	4351	4377	4404
48	4431	4458	4485	4512	4540	4568	4595	4613	4651	4680
49	4708	4736	4765	4794	4823	4852	4881	4911	4940	4970
0·50	5000	5030	5060	5091	5121	5152	5183	5214	5245	5277
51	5308	5340	5372	5404	5436	5469	5501	5534	5567	5600
52	5633	5667	5701	5734	5768	5803	5837	5871	5906	5941
53	5977	6012	6048	6083	6119	6155	6192	6228	6265	6302
54	6339	6377	6414	6452	6490	6528	6566	6605	6644	6683
55	6722	6762	6801	6841	6882	6922	6963	7003	7044	7086
56	7127	7169	7211	7253	7296	7339	7382	7425	7468	7512
57	7556	7600	7645	7689	7734	7779	7825	7871	7917	7963
58	8010	8056	8103	8151	8199	8246	8295	8343	8392	8441
59	8490	8540	8590	8640	8691	8741	8792	8844	8896	8948
0·60	9000	9053	9106	9159	9213	9267	9321	9375	9430	9485
61	9541	9597	9653	9710	9767	9824	9882	9940	9998	1006
62	1012	1018	1024	1030	1036	1042	1048	1054	1060	1066
63	1073	1079	1085	1092	1098	1105	1111	1118	1124	1131
64	1138	1145	1151	1158	1165	1172	1179	1186	1193	1200
65	1207	1214	1222	1229	1236	1244	1251	1258	1266	1274
66	1281	1289	1297	1304	1312	1320	1328	1336	1344	1352
67	1360	1369	1377	1385	1393	1402	1410	1419	1428	1436
68	1445	1454	1463	1473	1482	1491	1499	1508	1517	1526
69	1536	1545	1555	1564	1574	1583	1593	1603	1613	1623

<i>m</i>	0	1	2	3	4	5	6	7	8	9
0·70	1633	1643	1654	1664	1674	1685	1695	1706	1717	1727
71	1738	1749	1760	1771	1783	1794	1805	1817	1828	1840
72	1851	1863	1875	1887	1899	1911	1924	1936	1949	1961
73	1974	1987	1999	2012	2025	2039	2052	2065	2079	2092
74	2106	2120	2134	2148	2162	2177	2191	2206	2220	2235
75	2250	2265	2280	2296	2311	2327	2342	2358	2374	2390
76	2407	2423	2440	2456	2473	2490	2508	2525	2542	2560
77	2578	2596	2614	2632	2651	2669	2688	2707	2727	2746
78	2766	2785	2805	2825	2846	2866	2887	2908	2929	2950
79	2972	2994	3016	3038	3060	3083	3106	3129	3153	3176
0·80	3200	3224	3249	3273	3298	3323	3348	3374	3400	3427
81	3453	3480	3507	3535	3562	3590	3619	3648	3677	3706
82	3736	3766	3796	3827	3858	3889	3921	3953	3986	4019
83	4052	4086	4120	4155	4190	4225	4262	4298	4335	4372
84	4410	4448	4487	4526	4566	4606	4648	4689	4731	4773
85	4816	4860	4905	4950	4995	5042	5088	5136	5184	5233
86	5283	5333	5384	5436	5489	5542	5597	5652	5708	5765
87	5822	5881	5941	6001	6063	6125	6189	6253	6319	6386
88	6453	6522	6593	6664	6737	6811	6886	6963	7041	7120
89	7201	7283	7367	7453	7540	7629	7719	7812	7906	8002
0·90	8100	8200	8302	8406	8513	8621	8732	8846	8962	9080
91	9201	9324	9452	9581	9714	9850	9989	1013	1028	1043
92	1058	1074	1090	1107	1123	1141	1158	1177	1196	1215
93	1236	1256	1277	1299	1321	1345	1369	1393	1419	1445
94	1473	1501	1530	1560	1592	1624	1658	1692	1728	1766
95	1805	1846	1888	1933	1979	2027	2077	2130	2185	2244
96	2304	2368	2436	2506	2582	2660	2744	2833	2928	3029
97	3136	3251	3374	3507	3649	3803	3970	4150	4347	4564
98	4802	5005	5358	5684	6052	6468	6945	7493	8134	8892
99	9801	1091	1230	1409	1647	1980	2480	3313	4980	9980

POSITION OF THE DECIMAL POINT

<i>m</i>	$\frac{m^2}{1-m}$
0·0100	0·0001
0·0312	0·001
0·0952	0·01
0·271	0·1
0·619	1·0
0·917	10·
0·991	10·

Only four significant figures are given in the table, and the small table at the end indicates the position of the decimal point. For example, if we have found $m = 0.322$, the number corresponding is 1529, and as 0.322 lies between 0.271 and 0.619, $\frac{m^2}{1-m}$ is 0.1529.

Electrical Measurement of Temperature.—The resistance of pure metals is approximately proportional to the absolute temperature, and the temperature coefficient is nearly the same as that of gases, being 0.03 to 0.04 per degree at 0° C. As resistances can easily be measured to 0.0001 of their value, we can therefore determine on the average 0.003° by measurements of resistance; by special apparatus this accuracy can be increased ten or a hundred times.

The mode of using the resistance thermometer is susceptible of a great many modifications. As the practical measurement of resistance is based on comparison with other resistances, the resistance which varies with the temperature will in general be compared with one whose temperature is kept constant. This standard resistance should be made of some material with a temperature coefficient as small as possible, *e.g.* manganin, constantan (p. 217).

The connections between the constant and variable resistances must be arranged so that their change with the temperature, the distribution of which in the different connecting pieces cannot be accurately known, constitutes only a small proportion of the total change, and can consequently be neglected, or need be only approximately calculated. To attain this end the resistances themselves are made as great as possible, *i.e.* of long pieces of fine wire, while the connecting pieces are made of stout wire. The metals which conduct well, copper and silver, have a high temperature coefficient, so that it may often be advantageous to construct the connections not out of them but out of alloys which do not conduct so well but have a very small temperature coefficient.

The resistance thermometer must be graduated for several temperatures within which the temperatures to be measured lie. For this purpose melting and boiling points otherwise determined are to be used. This graduation is necessary on account of the resistance r not being a strictly linear function of the temperature; an equation of the form $r = a + bt + ct^2$ is usually sufficient.

To effect the graphic interpolation it is best not to plot r and t directly, but only the deviation from the linear formula. A coefficient b is selected so that at the highest value of the temperature interval investigated the deviation is zero, both positive and negative deviations being possible. The constant a is obtained from a measurement at 0°. In this way the graphic interpolation becomes much more exact, as its error is now only of the second order with regard to the fundamental magnitude. Such a method of procedure can be employed

whenever the function to be represented permits a similar convenient decomposition.

Let the following table represent under t and r the temperatures and corresponding resistances observed :—

t .	r .	$[r]$.	Δ .
0°	11·25	11·25	0·00
50°	12·78	12·93	-0·15
100°	14·39	14·60	-0·21
150°	16·10	16·28	-0·18
200°	17·95	17·95	0·00

and let us make the preliminary assumption that the resistance increases proportionally to the temperature up to 200°. As it increases by 6·70 between 0° and 200°, the formula for the resistance would be on this assumption— $[r] = 11·25 + 0·0335t$. The resistances calculated from this are given in the table under $[r]$, and the differences between them and the observed resistances under Δ . These differences are plotted against the temperatures and give the curve of

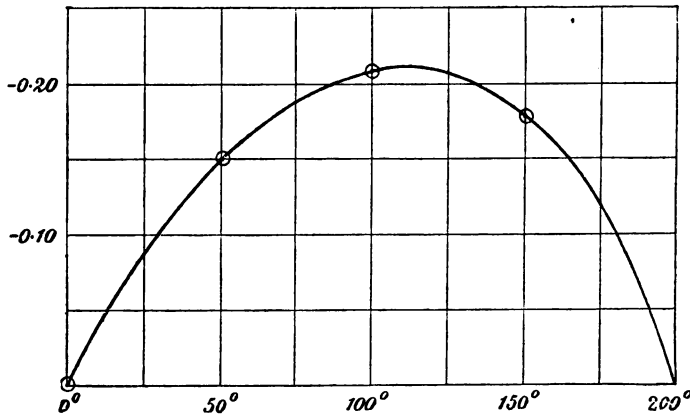

FIG. 184.

Fig. 184, from which the deviations for all intermediate temperatures may be obtained with a sufficient degree of accuracy.

Although the curve permits the easy determination of the resistances corresponding to definite temperatures, it is not convenient for the converse problem. If we have to determine the temperatures from the resistances, it is necessary to form an equation $t = a + \beta r + \delta$ where δ is the correcting term to be tabulated graphically, and is

again 0 at $t = 0^\circ$ and $t = 200^\circ$. We have then $\beta = \frac{200}{6.70} = 29.85$ and $a = -334.5$, so that we obtain the approximate equation

$$[t] = -334.5 + 29.85r.$$

This gives the following table:—

r .	t .	$[t]$.	δ .
11.25	0°	0°	0.0
12.78	50°	47.0°	3.0
14.39	100°	95.0°	5.0
16.10	150°	146.1°	3.9
17.95	200°	200°	0.0

and the corresponding curve (Fig. 185).

Suppose we wish to calculate the temperature corresponding to

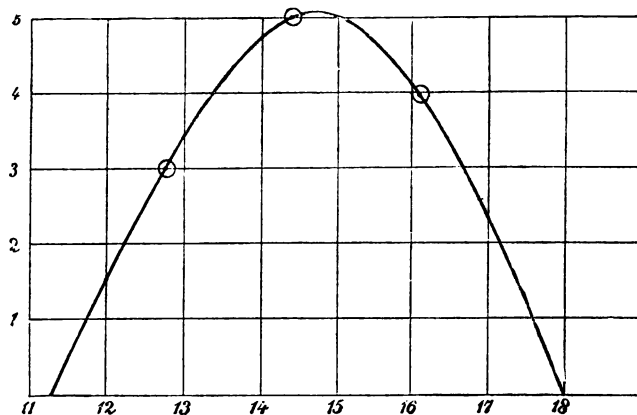

FIG. 185.

the resistance 15.00, we calculate $[t]$ from the equation $[t] = -334.5 + 29.85r$, which gives 113.3° , and then find from the curve that at $r = 15.00$ there is a correction of $+5.0^\circ$, so that the temperature required is $t = 118.3^\circ$.

Wheatstone's bridge is mostly used for the actual measurement of the resistances. The simplest case would be to make two resistances constant—say b and d in Fig. 169, a being the resistance subject to the change of temperature, and c a resistance which can be varied and measured at pleasure. The sensibility, however, may be doubled by exposing the resistances a and d simultaneously to the change of

temperature, b being constant, and c as before. For very small variations of temperature, the deflection of the galvanometer may be read instead of the resistance being changed. To be able to test, or redetermine, the coefficient of the galvanometer at any time, there may be brought into c a small additional resistance, which corresponds with the greatest variation of temperature to be measured. The observed temperatures are then represented as ratios of the galvanometer deflections, the unit being the deflection caused by the additional resistance. The temperature corresponding to this must be specially determined.

CHAPTER XVI

CHEMICAL DYNAMICS

Velocity of Chemical Processes.—Homogeneous liquid mixtures are usually employed for ascertaining the velocity of chemical reactions, as in the case of heterogeneous mixtures the size of the contact surface and the nature of the substances in its immediate neighbourhood are essential factors, which it is difficult either to keep constant, or to vary in any known way.

In order to follow the progress of a chemical process in liquids we must have a method of determining the composition at any instant. The initial composition is usually known, and the state in the course of the reaction can be expressed with reference to the time by a single variable, even although several substances take part in the action. Thus in a mixture of alcohol and acetic acid, four substances vary in amount as time elapses; alcohol and acetic acid diminishing, water and ethyl acetate (produced by the interaction of the first pair) increasing in quantity. But if the original quantities of the four substances, measured in molecular weights, are m, n, m', n' , then at any given time they are $m - x, n - x, m' + x, n' + x$, and the state is completely defined by the single variable x . From this there is only a deviation when several independent reactions take place simultaneously, and such cases have not yet been investigated with respect to their velocity of reaction.

Very different methods may be employed for determining the variable, and may be conveniently classed into physical and chemical methods. Inasmuch as most physical properties are a function of the chemical state of the liquid, any of them may be used as an analytical mode of ascertaining the state, those of course being selected which give the most favourable combination of convenience of execution and accuracy of result.

The properties here to be made use of are divisible into general and special properties. The former have a finite value not only for the substance to be determined but for all the other substances present, such as the solvent; for example, each substance has

its own specific volume and its own heat capacity. The special properties have finite values only for special substances, having a zero value for many or most other substances; as examples we have optical activity, selective absorption, electric conductivity.

The special properties are as a rule better adapted for analytical purposes than the general properties, for in a solution they vary proportionally to the quantity of the substance that possesses them, and the error in measuring such a property occasions an equal relative error in the quantity of substance calculated from it. On the other hand, in the case of general properties, we can only deduce the change in the quantity of a component from the difference of two numbers which represent the sum of the properties for the whole mixture in the two states to be compared, so that the relative errors are multiplied in the ratio in which that difference stands to the total value of the property. This multiplication of the error of experiment is occasionally very great; factors like 100 or 1000 are not uncommon, so that general properties which admit of very exact numerical determination can alone be employed for analytical purposes.

In every case then we must first investigate whether suitable special properties can be found, and only if they cannot should we resort to the measurement of general properties. Of the latter those should be selected which give the most accurate differential determinations, or with a given degree of accuracy are susceptible of the most convenient and rapid measurement.

The chemical methods are based on the ordinary processes of analytical chemistry, and may be divided into gravimetric and volumetric methods. The latter are to be preferred if they can be used at all, for with a given degree of accuracy they demand incomparably less time in the execution. Alkalimetric and iodometric measurements are the most generally useful, and methods depending on the determination of the volume of gases may also be frequently employed with advantage.

With regard to the practical execution of the physical methods the separate sections must be referred to, in which the special processes have been discussed. The following generalities refer to the chemical methods:—

Volumetric Methods.—Directions as to the principles and practical details of volumetric analysis are very numerous, but many improvements which are not generally known have been effected in the course of work in my laboratory for physico-chemical purposes.

Volumetric analysis is based on the quantity of the substance to be determined being deduced from the quantity of a reagent necessary to bring about a definite and obvious process known as the end reaction. Thus the quantity of an alkali may be estimated from the amount of acid which must be added to exactly decolorise the alkaline solution coloured red with phenol-phthalein. The sharpness of the measure-

ment depends on the sharpness of the end point, and before any process is adopted for a series of measurements it must be seen how sharp the end reaction is, *i.e.* how little of the reagent is necessary to make the phenomenon in question distinctly appear. From this the smallest quantity of the substances necessary for each measurement may be determined, so that we can decide on what scale the experiments must be conducted, the smallest scale being of course chosen on practical grounds. The possible error of the separate measurements should not exceed 1 per cent in ordinary cases; in special circumstances greater accuracy may be obtained, or for other reasons a larger error must be put up with.

As the volumetric liquid becomes more dilute the error¹ depending on the measurement of volume diminishes; but, on the other hand, the increasing difficulty of recognising the end point occasions an increase of the error. The dilution, if other circumstances admit of it, is chosen so that half a drop, 0.02-0.03 cc., of the reagent effects a difference which is distinctly recognisable.

Vessels for Velocity of Reaction.—The simplest case is when the liquid under investigation is affected to a measurable extent neither by contact with the air nor by the evaporation proceeding in the interior of the partially filled bottle. The liquid previously warmed to the temperature of the thermostat is placed in a stoppered bottle in somewhat greater quantity than is necessary for a sufficient number of single estimations, and allowed to remain at the constant temperature. From time to time suitable quantities of liquid are removed from the bottle by means of a pipette in order to perform the determination with them. In this way we may determine, for example, the rate of inversion of cane-sugar or of the catalysis of methyl acetate at the ordinary temperature.

The bottle must be sunk in the thermostat nearly up to its mouth in order that there may be no distillation from the hotter to the colder parts. To make the bottle retain this position after a portion of its contents has been removed, it must be weighted with a piece of sheet lead fastened to the bottom with marine glue, sealing-wax, or a mixture of wax and resin. Pfeffer recommends plates held on by springs (Fig. 186), as they can be more easily adjusted and removed.

If such an arrangement cannot be adopted, the quantities of liquid necessary for a measurement are distributed in small thin-walled vessels of the forms shown in Fig. 187. I. and II. are used at the ordinary temperature for mixtures which contain a volatile substance or one altered by the components of the air. I. is either sealed at both ends, or what is often possible, closed by pellets of adhesive wax. II. is a measuring flask with mark and glass stopper, the upper part of the neck being very short.

¹ Here and in similar discussions it is the relative error which is always understood.

The form III. is used for higher temperatures, and is filled by a fine-pointed pipette through the upper opening, after which it is sealed. The upper portion must not be wetted before sealing.

If it is only necessary to prevent the evaporation of water up to 100° , a simple test-tube IV. closed with a rubber stopper carrying a glass tube drawn out to a capillary point may be used. This arrangement has worked well in measurements of the inversion of cane-sugar by very dilute acids at 100° .

In analysing the contents the bulk of the liquid should be transferred directly into a basin and titrated approximately, the vessel being then rinsed out with the resulting liquid, and the titration carefully completed.

In all delicate measurements we must take account of the fact that glass vessels, especially new ones, give up alkali to aqueous

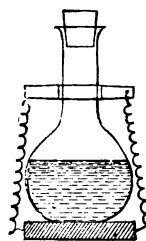

FIG. 186.

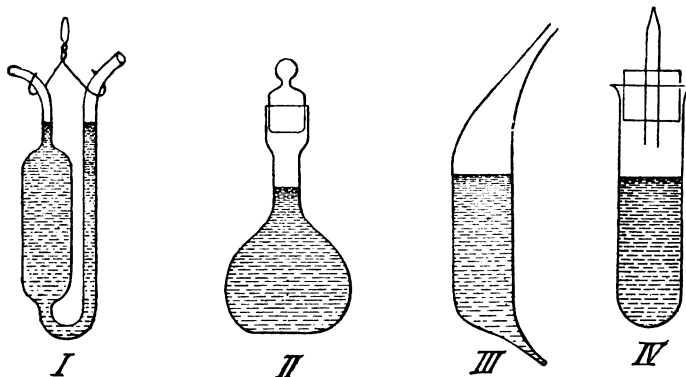

FIG. 187.

solutions, particularly at high temperatures. At present various sorts of glass have been introduced¹ which offer considerable resistance to this action, so that the vessels should be made of them when this is an object to be considered. A means of greatly diminishing this error in the case of ordinary glass is to treat it with steam.

A funnel with a glass tube fixed vertically in its neck is set into a flask in which water is kept boiling (Fig. 188). The flasks and other vessels to be treated with steam are inverted over this tube, so that the condensed water flows into the funnel; when a quantity has collected, the stopper is loosened and the water returns to the flask (Abegg). Ten to fifteen minutes' treatment is usually sufficient; the

¹ Made by Schott und Genossen, Jena; Kaehler und Martini, Berlin.

flasks are then at once dried by a current of air. The improvement experienced by the glass after treatment is very surprising.

Catalysis of Methyl Acetate.¹—A burette and bottle are arranged as in Fig. 73, p. 88, to contain an approximately $\frac{1}{20}$ normal solution of baryta, 8 g. of baryta crystals being dissolved in 1 litre of hot water and diluted to the required volume. The liquid is turbid with barium carbonate; this is not filtered off, but the solution is allowed to settle and the clear portion poured off on the following day into the burette reservoir. After the strength has been accurately determined (*e.g.* with potassium tetroxalate), semi-normal solutions of various acids, such as nitric, sulphuric, hydrochloric, or monochloroacetic acid, are prepared by titration against it, and a thermostat is regulated to a constant temperature, say 25°.

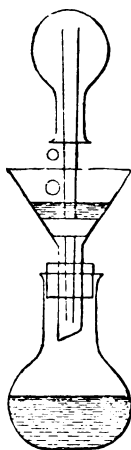

FIG. 188.

Bottles of 25 cc. capacity, loaded with lead and purified by steam, are provided with numbered paraffined corks, and into each is introduced 20 cc. of the acid solution, to which, after warming in the thermostat, 1 cc. of methyl acetate is added, and the mixture thoroughly shaken up. Immediately after mixing, 1 cc. of the liquid is removed and titrated, the time being noted at which the first drop of baryta water is added to the solution; this is taken as the initial point of the reaction.

At suitable times, at first every twenty or thirty minutes, later at longer intervals, other portions are removed and titrated, the bottles always remaining in the water of the thermostat. A residue of at least 5 cc. is allowed to stand for two days or longer at the constant temperature, and in it the final state of the solution is determined.

If a_0 is the initial titre of the solution in cc. of baryta water, a_1, a_2, \dots the amounts of baryta solution necessary at the later titrations, and A the constant final titre when the solution has attained equilibrium, the following relation must be fulfilled:—

$$\frac{\log (A - a_0) - \log (A - a_n)}{t_n} = \text{const.},$$

t being the time, given in minutes, as is usual in such cases.

The equation for the reaction is of the first order, and, if b is the original quantity of ester, and x the quantity decomposed at the time t , leads to the relation $\log \frac{b}{b-x} = kt$, where k is a constant. Now b is proportional to $A - a_0$, and x is proportional to $a_n - a_0$, so that by substitution we get the equation given above.

¹ Ostwald, *Jour. prakt. Chem.*, 28, 449, 1883.

The constant for semi-normal hydrochloric acid, to which 1 cc. of methyl acetate has been added, is 0.0013 at 25°. The mean of several independent series should not vary more than 1 %, although the values from the separate determinations in any one series at the middle period of the reaction, where they are most accurate, may vary 3 % from the mean.

As an exercise the student should calculate the effect of an error in the titration of definite magnitude (say 0.05 cc.) on the relative accuracy of the constant according to the method of p. 3, and plot out the relation obtained for various values of x or $a_1 - a_0$, x being expressed in percentages of the total amount b .

Inversion of Cane-Sugar.—A clear 20 % solution of sugar is prepared by dissolving 200 g. of white loaf-sugar in water, diluting to 1 litre, and carefully filtering. If it is to be kept for any length of time it should be sterilised by heating for half an hour in the steam-bath. Soxhlet's milk bottles with automatic stoppers are very convenient for preserving the solution, and can be purchased from dealers in medical appliances. The smaller sizes holding 0.2 to 0.3 l. are best, and should be blown out with steam before being used.

This solution is warmed to the temperature of experiment (25°), and 10 cc. of it are mixed with 10 cc. of a normal solution of hydrochloric acid, also at 25°, in a bottle holding 20 cc., the rotation of the mixture being at once determined. For this purpose the tube of the polarising apparatus is warmed to 25° by a current of water flowing through the jacket. The tube is cleaned and dried after the glass plates have been removed. One of these is then screwed on, and the tube filled in the vertical position until a small convex meniscus appears at the top, the second plate being then slid on sideways, so that the excess of liquid is pressed out before it and the tube is filled without air-bubbles being left behind. The second cap is now screwed on and the tube is ready for an observation.

The experiment may be so arranged that water at 25° flows through the jacket of the polarimeter during the whole time; this necessitates having the apparatus close by the thermostat, the observing tube being freely movable and connected up with long rubber tubes. It is more convenient and scarcely less accurate, however, to disconnect the tube, after it has been warmed, from the water-supply, in order that it may be easily filled, and then to connect it up again with the water at 25° during the observation. In this way the polarimeter and a supply of water at 25° may be kept in the dark room, while the thermostat and the liquid under investigation are kept in the laboratory.

During the first phases of the inversion, the action proceeds so rapidly that smaller and smaller readings are obtained as the observation is repeated. One reading per minute is made, and the mean of three or five readings taken as the value for the time of the middle reading.

After the observation, the contents of the tube, which should contain 10-15 cc., are emptied into the bottle, in which the rest of the liquid has remained without being taken out of the thermostat. After a suitable interval a new observation is made, and thus a great number of measurements may be performed with a comparatively small quantity of solution. In course of time the solution becomes slightly muddy from dust falling in, and must be filtered at the constant temperature.

After eight or ten observations have been made, a period is allowed to elapse which is ten times as great as that necessary for half inversion of the sugar, and then the final reading is taken. If a_0, a_1, a_2, \dots are the separate readings, a_0 being the first, from which the time is reckoned, and A the final reading, all given in degrees and decimals of a degree, we have the relation

$$\frac{\log (a_0 - A) - \log (a_n - A)}{t_n} = \text{const.},$$

where t_n is the time corresponding to the reading a_n . The sign of the angle must be taken into account, as it is first positive and then passes through zero and becomes negative.

The student should tabulate the relation between a and t with rectangular co-ordinates, and discuss the influence of the errors in a on the value of the constant, in order to determine the region in which the measurements give the best result.

Hydrochloric acid mixed in the above way as a normal solution with an equal volume of 20 % sugar solution gives at 25° the constant 0.00205. With good working the separate measurements will give a constant deviating not more than 1 % from the mean. Half an hour may elapse between the first and second measurements, the intervals then becoming gradually larger.

An analogous experiment with acetic acid goes almost exactly 200 times more slowly, so that the first tolerably certain measurement can only be made after five or six days. As it is impossible in such a case to wait for the final state, the rotation corresponding to it must be calculated from the rule that, for every degree to the right before the inversion, we have a rotation of $(0.44 - 0.005t)$ to the left after the inversion is complete, t being the temperature. For 25°, therefore, the final rotation is -0.315° for the initial rotation of $+1^\circ$. The formula is not perfectly exact, but the error in it is small and never reaches 1 % of the total value. In relative estimations its influence disappears altogether.

INDEX

ACCURACY of measurements, 2
Adjustment for reading scales, 31
of spectrometer, 139
Air-pumps, 189

BACK-LASH of screw, 22
Balance, 35
Barometer, 77
Basicity of acids, 235
Beam compass, 26
Boiling point, 112
on thermometer scale, 47
elevation of, 184
Bunsen's graduating apparatus, 26
pump, 189
Buoyancy of air, 38
Burettes, 87

CALCULATING tables, 19, 20
Calculation, 1
Calibration of burette, 87, 106
thermometer tube, 47
wire, 223
Callipers, 28
Calorie, 123
Calorimeters, 120, 132-134, 136
Capillarity, 163
Capillary depression of mercury, 74
electrometer, 202
Catalysis of methyl acetate, 250
Cathetometer, 29
Cells, galvanic, 196
Clark element, 193
Coefficient of absorption, 173
of expansion, 110
of refraction, 139
of velocity, 250
Colorimetry, 150
Commutator, 199
Compasses, 28
Composite errors, 6
measurements, 2
Conductivity of electrolytes, 222
Connections, 197

Constant cells, 193
errors, 6, 7
interval, probable value, 8
of electrolytic dissociation, 233
of refraction, 146
of velocity, 250
Correction, 8
multiple, 11
for set of weights, 41
for exposed column of thermometer, 46
for meniscus, 107
Critical pressure, 116
temperature, 114
volume, 117
Curved rulers, 11

DEFINITION of an object, 1
Density, 90, 94
Depression of freezing point, 180
of mercury in tube, 74
Diameter of cylinder, 28, 30
Dilatometers, 108-111
Dissociation constant, 233
table, 236
Divided pipette, 89
Dividing engine, 22, 25
Division, 14
of a slide rule, 17
of a line into arbitrary units, 27

ELECTRICAL connections, 197
determination of temperature, 242
units, 192
Electrodes, normal, 215
Electrolytic conductivity, 222
cells for, 225
Electromagnetic temperature regulator, 62
Electrometers, 202-209
Electromotive force, 209
Elements for constant E. M. F., 193-196
Elevation of boiling point, 184
Error, constant, 6, 7
incidental, 7
mean, 5

- Error, parallax, 29
 probable, 6
 of composite measurement, 2
 Etching on glass, 23
 Expansion by heat, 108

FLASKS for measuring, 89
 Flexible rulers, 11
 Freezing point on thermometer scale, 46
 depression, 180
 French curves, 10

GALVANOMETER, 200
 Gas currents, 189
 Gas-free liquids, 174
 Gas-pressure regulators, 190
 Gases, density, 99
 solubility, 173
 Glass-blowing, 66-72
 Glass scales, 23
 Gouy element, 195
 Graduation of burettes, 87
 pipettes, 85
 Graphic interpolation, 10
 Graver, 23

HEAT, specific, 123, 127
 unit, 123
 of combustion, 134
 of fusion, 129
 of solution, 132
 of vaporisation, 130
 Height of mercury column, 74
 Hydrofluoric acid for etching, 23
 Hydrometers, 95
 Hydrostatic balance, 95

ICE calorimeter, 136
 Incidental errors, 7
 Index of refraction, 139
 Induction coil, 223
 Interpolation, 9
 Inversion of cane-sugar, 251

KEYS for electric connection, 197
 Kilogram, standard, 44

LEAST squares, 5
 Length, measurement, 28
 Lens, reading with, 31
 Light of definite wave-length, 145
 Litre, 82
 Mohr's, 84
 Logarithmic calculating table, 19
 Logarithms, 15
 Loss of weight in air, 38

MANOMETERS, 73-81
 Mariotte's bottle, 190
 Mean error, 5
 Measurements, calculation of, 4

 Measurements, composite, 2
 Measuring flasks, 89
 Meniscus correction, 107
 Mercury, bottle for, 199
 capillary depression of, 74
 purification of, 84
 vapour pressure of, 106
 Micrometer microscope, 33
 screw, 30
 Microscope for measuring lengths, 29, 33
 Mohr's litre, 84
 Molecular conductivity, 228
 volume, 111
 weights in solution, 180-191
 Motors, 65
 Multiple corrections, 11

OHM, 193
 legal, 194
 Optical activity, 158, 251

PARALLACTIC error, 29
 Photography, 155-158
 Pipettes, 84, 89, 177
 Piston manometer, 81
 Planimeter, 33
 Platinum, welding, 72
 Polarimeter, 159
 Potential difference, 202-216
 Pressure, 73-81
 critical, 116
 Probable error, 6
 value of constant interval, 8
 Pycnometer, 90

QUADRANT electrometer, 208

RAOULT'S method, 180
 Reaction velocity, 246
 Reading scales, 31
 height of mercury column, 74
 Reduction of observations, 1
 Refraction coefficient, 139
 constant, 146
 Refractometer, 142, 144
 Regulation of gas-pressure, 190
 temperature, 51-65
 Resistance, 216
 unit, 193, 194
 box, 211
 Rotation of plane of polarisation, 158,
 251
 Rulers, flexible, 11

SCALES on glass, 23
 Screw contacts, 200
 Screws, 22, 25
 Shortened multiplication and division, 14
 Slide rule, 16
 Soldering, 220
 Solubility, 169-179

- Specific conductivity, 228
 gravity, 90-107
 balls, 96, 178
 bottle, 90
 heat, 127
 heat of water, 123
 volume, 90
 Spectra, 147
 Spectrometer, 139
 Spectrophotometry, 152
 Spring manometer, 79
 Standard cells, 193
 electrode, 215
 Stirring gear, 64
 Surface measurement, 33
 tension, 163
- TELEPHONE, 226
 Telescope and scale, 29, 202
 Temperature, constant, 51
 critical, 114
 electrical measurement, 242
 regulators, 54-65
 Thermoelectric batteries, 197
 Thermometers, 44, 119, 242
 Thermostats, 51-65
- UNIT of heat, 123
- Units, electrical, 192
- VACUUM manometer, 76
 Vapour density, 100
 pressure, 112
 of mercury, 106
 of solutions, 188
 of water, 103
 Velocity of reaction, 246
 Vernier, 32
 Viscosity, 162
 Volume, 34, 82
 critical, 117
 molecular, 111
 specific, 90
- WATER, pure, 234
 specific volume, 83
 vapour pressure, 103
 Weighing, 35-44, 93
 "Weight" of an observation, 6
 Weight-testing, 40
 Welding platinum, 72
 Wheatstone's bridge, 216, 226
 table, 230
 Wire gauge, 30
- ZERO of thermometer, 45, 46

THE END

h





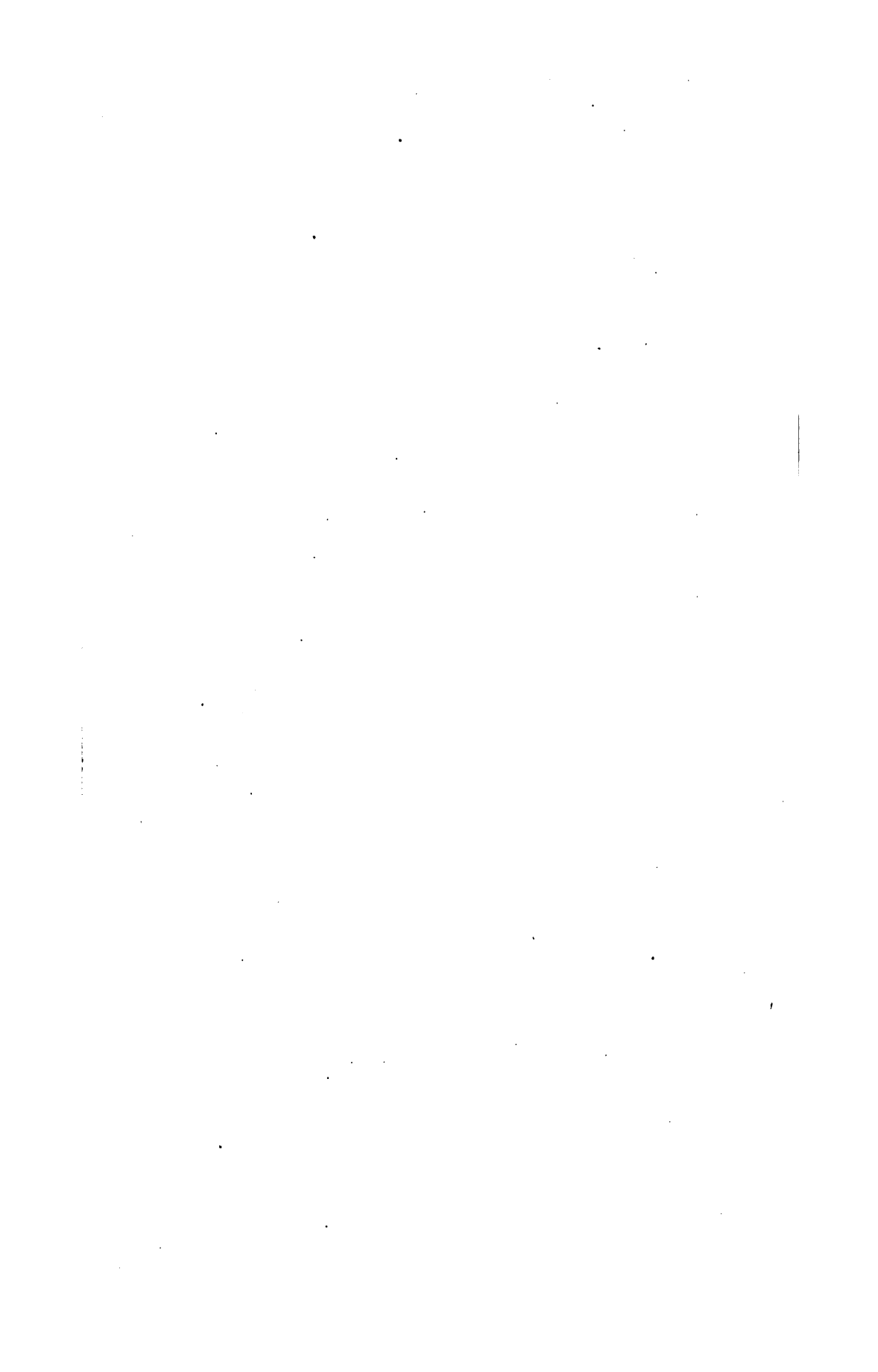



This book should be returned to the Library on or before the last date stamped below.

A fine of five cents a day is incurred by retaining it beyond the specified time.

Please return promptly.

DUE APR 5 1915

DUE MAY 3 1915
DUE MAR 24 1917

DUE APR 26 1917

NOV 28 1921

DUE NOV 10 1924

DUE JAN 13 1925

~~DUE JAN 21 33~~

~~DUE DEC 3 40~~

3386849

DUE JAN 72 H

Phys 408.94.3
Manual of physico-chemical measurem
Cabot Science 003438298



3 2044 091 954 891